



---

## Ground-Based Midcourse Defense (GMD) Extended Test Range (ETR)



---

## Final Environmental Impact Statement

Volume 1 of 3: Chapters 1-4

---

July 2003

---

# Ground-Based Midcourse Defense (GMD) Extended Test Range (ETR) Final Environmental Impact Statement



**Volume 1 of 3**

July 2003

Missile Defense Agency

**COVER SHEET**  
**FINAL ENVIRONMENTAL IMPACT STATEMENT**  
**GROUND-BASED MIDCOURSE DEFENSE (GMD)**  
**EXTENDED TEST RANGE (ETR)**

- a. Lead Agency: Missile Defense Organization
- b. Preparing Agency: U.S. Army Space and Missile Defense Command
- c. Cooperating Agencies: Federal Aviation Administration, Office of the Associate Administrator for Commercial Space Transportation
- d. Proposed Action: Provide operationally realistic testing for GMD ETR.
- e. Affected Jurisdictions: Kodiak Launch Complex, Kodiak Island Borough, Alaska; Vandenberg Air Force Base (AFB), Santa Barbara County, California; Reagan Test Site, United States Army Kwajalein Atoll; Pacific Missile Range Facility, Barking Sands, Kauai, Hawaii; Eareckson Air Station, Shemya Island, Alaska; Midway Atoll; King Salmon, Bristol Bay Borough, Alaska; Cordova, Valdez-Cordova Census Area, Alaska; Pillar Mountain, Kodiak Island Borough, Alaska; Pashagshak Point, Kodiak Island Borough, Alaska; Homer, Kenai Peninsula Borough, Alaska; Adak, Adak Island, Alaska; Pillar Point, San Mateo County, California; Wake Island, Oceania Atoll; Bremerton, Kitsap County, Washington; Pearl Harbor, Honolulu County, Hawaii; Port Hueneme/San Nicolas Island, Ventura County, California; Naval Station Everett, Snohomish County, Washington; Valdez, Valdez-Cordova Census Area, Alaska; Beale Air Force Base, Yuba County, California; Clear Air Force Station, Denali Borough, Alaska
- f. Inquiries on this document may be directed to: U.S. Army Space and Missile Defense Command, ATTN: SMDC-EN-V (Ms. Julia Elliott), 106 Wynn Drive, Huntsville, AL 35805, by e-mail at [gmdetreis@smdc.army.mil](mailto:gmdetreis@smdc.army.mil), or by phone at 1-800-823-8823.
- g. Designation: Final Environmental Impact Statement
- h. Distribution/Availability: DISTRIBUTION A. Approved for public release; distribution is unlimited.
- i. Abstract: The Missile Defense Agency is proposing to develop the capability to conduct more realistic interceptor flight tests in support of GMD. The extension of the existing GMD test range would increase the realism of GMD testing by using multiple engagement scenarios, trajectories, geometries, distances, and speeds of target and interceptors that closely resemble those in which an operational system would be required to provide an effective defense. Extended range testing would include pre-launch activities, launch of targets and Ground-Based Interceptors from a number of widely separated locations, and missile intercepts over the Pacific Ocean. Target missiles would be launched from Vandenberg AFB, Kodiak Launch Complex, Pacific Missile Range Facility, Reagan Test Site (RTS), or from mobile platforms in the western Pacific Ocean. Interceptor missiles would be launched from Vandenberg AFB, Kodiak Launch Complex, or RTS. Dual target and interceptor missile launches would occur in some scenarios. Existing, modified, or new launch facilities and infrastructure would support these launch activities at the various locations.

Missile acquisition and tracking would be provided by existing test range sensors, ship-borne sensors, a Sea-Based Test X-Band Radar, and a mobile sensor (TPS-X) positioned at Vandenberg AFB, Kodiak Launch Complex, or RTS; and existing/upgraded radars at Beale AFB, California, Clear Air Force Station, and Eareckson Air Station, Alaska. In-Flight Interceptor Communications Data Terminals would be constructed near the proposed Ground-Based Interceptor launch sites. Commercial satellite communications terminals would be constructed at launch locations that do not have fiber optic communications links.

---

# EXECUTIVE SUMMARY

---

ES1.1	Introduction .....	es-1
ES1.2	Background .....	es-1
ES1.3	Purpose and Need for the Proposed Action .....	es-2
ES1.4	Proposed Action.....	es-4
ES1.5	Proposed Alternatives .....	es-4
ES1.6	No Action Alternative .....	es-6
ES1.7	Decision To Be Made.....	es-6
ES1.8	Scope of the Environmental Impact Statement .....	es-7
ES1.9	Scoping Process .....	es-8
ES1.10	Summary of the Draft Environmental Impact Statement Public Review Process .....	es-9
ES1.11	Methodology of the Environmental Impact Statement.....	es-9
ES1.12	Summary of Environmental Impacts.....	es-9
	ES1.12.1 No Action Alternative.....	es-10
	ES1.12.2 Proposed Action Alternative 1 .....	es-10
	ES1.12.3 Proposed Action Alternative 2.....	es-16
	ES1.12.4 Proposed Action Alternative 3.....	es-17

# EXECUTIVE SUMMARY

---

## ES1.1 INTRODUCTION

This Executive Summary includes Background, Purpose and Need for the Proposed Action, Proposed Action, Proposed Alternatives, Decision to be Made, Methodology of the Environmental Impact Statement (EIS), and Summary of Environmental Impacts. Tables ES-1 through ES-12 include an Impacts and Mitigations Summary for each location and for the No Action Alternative at all locations.

## ES1.2 BACKGROUND

The National Environmental Policy Act (NEPA) of 1969 as amended (42 U.S. Code [USC] 4321, et seq.), the Council on Environmental Quality (CEQ) Regulations for Implementing the Procedural Provisions of NEPA (40 Code of Federal Regulations [CFR] 1500-1508), Department of Defense (DoD) Instruction 4715.9, *Environmental Planning and Analysis*, and the applicable Service environmental regulations that implement these laws and regulations, direct DoD officials to consider environmental consequences when authorizing and approving federal actions. Accordingly, this EIS examines the potential for impacts to the environment as a result of the proposed construction, operation, and test activities associated with the proposed Ground-Based Midcourse Defense (GMD) Extended Test Range (ETR). Under this Proposed Action, additional test facilities, including the Sea-Based Test X-Band Radar (SBX), test equipment, infrastructure, and communications links would be constructed and operated for the purpose of providing more realistic GMD flight testing in the North Pacific Region. Existing range facilities would be enhanced, and additional launch and support sites would be established to support more robust missile flight tests.

Within the DoD, the Missile Defense Agency (MDA) (formerly the Ballistic Missile Defense Organization) is responsible for developing and testing a conceptual Ballistic Missile Defense System (BMDS). There are three segments that make up the BMDS, Boost Phase Defense, Midcourse Defense, and Terminal Defense. Each segment of the BMDS is being developed to destroy an attacking missile in the corresponding boost, midcourse, or terminal phase of its flight. The boost phase is the portion of a missile's flight in which it produces thrust to gain altitude and acceleration. This phase usually lasts between 3 to 5 minutes. The midcourse phase occurs outside much of the Earth's atmosphere and the missile coasts in a ballistic trajectory. This phase can last as long as 20 minutes in the case of intercontinental ballistic missiles. During the terminal phase, the missile enters the lower atmosphere and continues on to its target. This phase lasts approximately 30 seconds. Each segment of the BMDS is composed of one or more elements, each of which consists of an integrated set of technology components, such as interceptors, radars, and communication links. GMD is one such element.

The GMD Joint Program Office, within the MDA, is responsible for overseeing the development of the GMD element. An operational GMD element architecture would include the five key components listed below and shown in figure ES-1.

- Ground-Based Interceptors (GBIs)
- X-Band Radar
- GMD Battle Management Command, Control, and Communications facilities and links
- Upgraded Early Warning Radars
- Space-Based Detection Capability

In July 2000, the MDA completed the National Missile Defense (NMD) Deployment EIS to support decisions concerning deployment of a GMD (formerly NMD) element. At the direction of the Secretary of Defense, however, the MDA re-focused the GMD element on operationally realistic testing under the concept of the GMD ETR. This EIS serves to analyze the proposed GMD ETR actions and alternatives for potential impacts on the environment.

On 17 December 2002, President George W. Bush announced plans to begin deployment of an initial set of missile defense capabilities by the year 2004. The deployment capability would be used in a defensive mode. This decision, however, is outside the scope of this document. Furthermore, the full scope and location of those assets are not yet ripe for NEPA analysis and will be the subject of future NEPA documentation, as appropriate. It is possible that some of those assets could share assets in common with some of those of the GMD ETR. Where further NEPA documentation is required, the limited deployment decision would examine any environmental impacts in its cumulative effects section, as applicable.

### **ES1.3 PURPOSE AND NEED FOR THE PROPOSED ACTION**

The proliferation of weapons of mass destruction and long-range ballistic missile technology is increasing the threat to our national security. The GMD element would defend all 50 states against limited ballistic missile attack. The Secretary of Defense has identified the need to gain a higher level of confidence in the capability of the GMD to defend the United States through more robust interceptor flight tests under more realistic conditions.

The purpose of the Proposed Action is to provide for more realistic flight tests in support of development of the GMD element. The ETR would achieve this by providing additional target and interceptor launch locations, and sensors, in a wider range of intercept engagements and under more stressing conditions.

More realistic testing using trajectories and distances that closely resemble those required of an operational element is needed to ensure the GMD element being developed has the capability to defend the United States against limited missile attacks. To meet this need, the MDA proposes to gain a higher level of confidence in GMD's capabilities to defend the United States through more robust system testing under more realistic conditions.

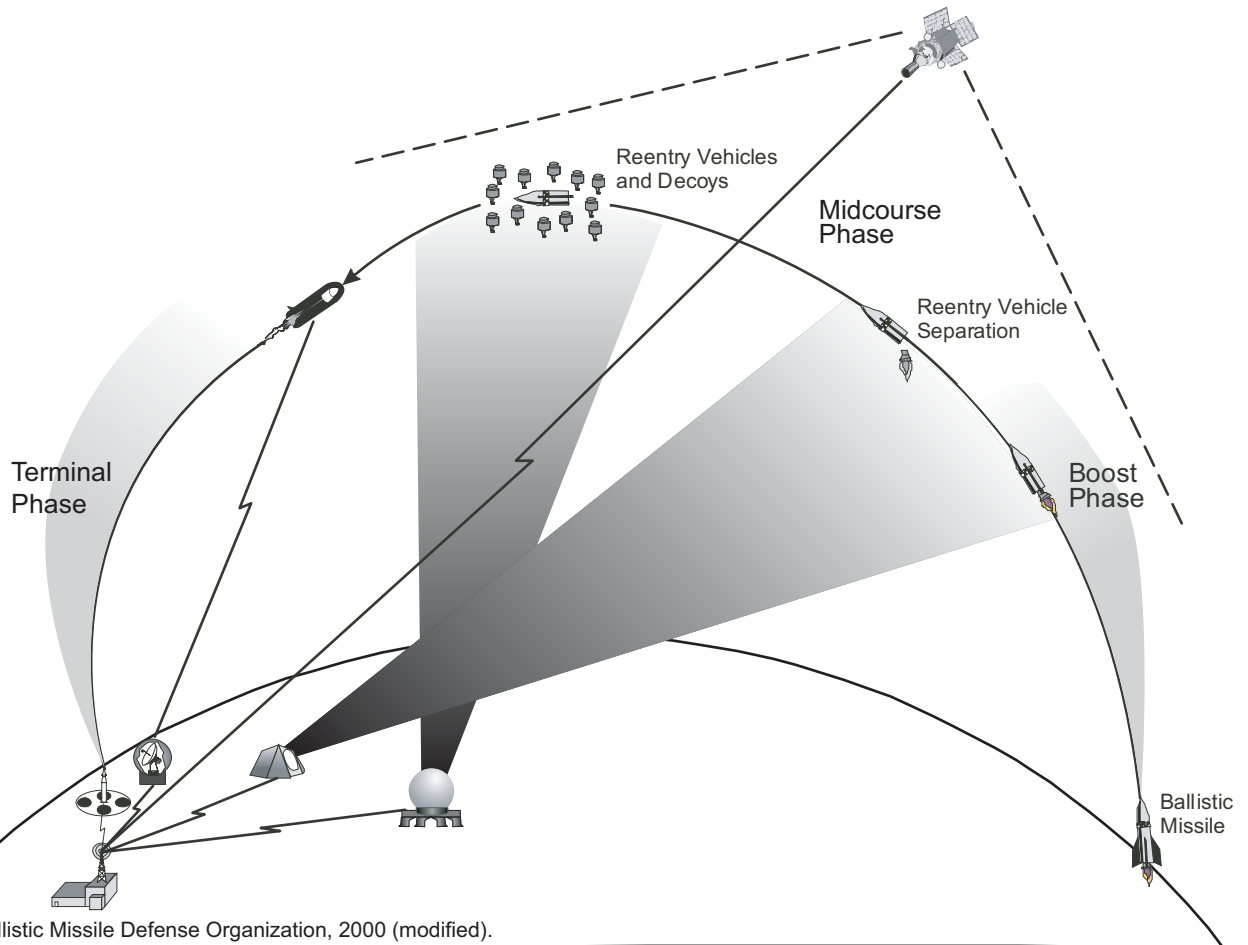
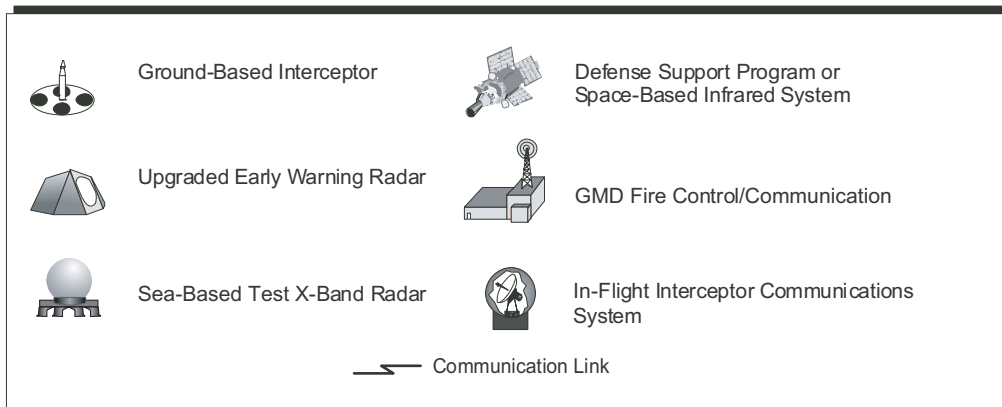

**EXPLANATION**

Note: Locations in this figure are for illustrative purposes only and are notional

**GMD Element Architecture**

Not to Scale

**Figure ES-1**

Currently, the existing test ranges located in the Pacific Region and elsewhere are limited in their capabilities to provide for a geographically dispersed operational environment, suitable for GMD types of testing. As a result, current GMD element testing is constrained by how missile flight tests can be conducted, and in opportunities for multiple engagement scenarios.

## **ES1.4 PROPOSED ACTION**

The Proposed Action is to construct and operate additional launch and test facilities including the SBX in the Pacific Region, and to conduct more realistic interceptor flight tests in support of GMD development. The extension of existing U.S. test ranges would increase the realism of GMD testing by using multiple engagement scenarios, trajectories, geometries, distances, and speeds of targets and interceptors that more closely resemble those for which an operational system would provide an effective defense. The GMD ETR testing would include pre-launch activities, launch of targets and GBIs from a number of widely separated locations, and missile intercepts over the Pacific Ocean. Potential GMD ETR test and test support locations are shown in figure ES-2.

For the purpose of this EIS, a flight test or test event represents a target missile flight, an interceptor missile flight, an intercept of a target missile, or a test of a sensor(s) independent of a missile flight test. Most tests would include the launch of a target missile; tracking by range and other land-based, sea-based, airborne, and space-based sensors; launch of an interceptor missile; target intercept; and debris impacting into broad open areas of the Pacific Ocean. Some test events proposed for later in the program would require multiple target and/or interceptor missile flights to validate GMD system performance. A total of approximately 10 launches per year is anticipated for the entire GMD ETR test program. For each of the alternatives, the proposed GMD ETR activities could include up to five missile launches (interceptors and/or targets) from a specific launch facility per year. The GMD ETR testing activities would likely occur over a period of approximately 10 years following a decision to proceed.

## **ES1.5 PROPOSED ALTERNATIVES**

The alternatives for implementing the Proposed Action represent architectures for achieving more realistic interceptor flight tests in the Pacific Region. These architectures are organized around potential additional GBI missile launch sites, with other new and existing test components being located to provide maximum test effectiveness. For analysis purposes in this EIS, three alternative test architectures have been identified based on developing additional missile launch capability at (1) Kodiak Launch Complex (KLC), Alaska; (2) Vandenberg Air Force Base (AFB), California; and (3) both KLC and Vandenberg AFB. Target missiles launched as a part of this ETR program would originate from KLC; Vandenberg AFB; Pacific Missile Range Facility (PMRF), Hawaii; Reagan Test Site, Kwajalein Atoll; or from a mobile air or sea launch platform in the Pacific region. All missile intercepts would occur over the Pacific Ocean. Each alternative would include common GMD test components consisting of GBIs, target missiles, In-Flight Interceptor Communication System Data Terminals (IDT), the SBX, and other sensors and instrumentation.





**EXPLANATION**

Note: Although Midway was an alternative site in the Draft EIS, MDA has determined that it is no longer a reasonable alternative and will not be a proposed site for ETR activities. The IDT on-board the SBX would perform the function that had been planned for Midway. The discussion of Midway has been retained in the Final EIS, however, in order to preserve the work that has already been performed.

**Potential GMD ETR Test and Test Support Locations**

Pacific Ocean

**Figure ES-2**



Not to Scale

## **ES1.6 NO ACTION ALTERNATIVE**

Under the MDA No Action Alternative, the GMD ETR would not be established, and additional facilities and components to be used in ETR operations would not be built. Existing launch sites and test range activities, however, would continue at the various locations, including support of ongoing GMD test activities. The Federal Aviation Administration (FAA) also has a No Action Alternative related to this EIS, as described below.

## **ES1.7 DECISION TO BE MADE**

The initial decision to be made by the MDA is whether to implement the Proposed Action to construct and operate additional GMD test facilities, infrastructure, and communication links to enable the MDA to conduct enhanced GBI flight testing; or to choose the No Action Alternative. If the MDA selects the Proposed Action, then a second decision would be made as to which of the three alternative interceptor launch scenarios and locations would most effectively meet the objectives of the enhanced test program.

The FAA, which is a cooperating agency for this EIS, will also rely on this analysis to make its licensing decisions for the KLC. The FAA, Office of the Associate Administrator for Commercial Space Transportation, is a cooperating agency because of its regulatory authority in licensing the operation of KLC, as defined in 49 USC Subtitle IX—Commercial Space Launch Activities, 49 USC 70101-70121 and supporting regulations. The FAA has special expertise and legal responsibility related to the licensing of commercial launch facilities. The FAA is responsible for providing oversight and coordination for licensed launches and protecting the public health and safety, safety of property, and national security and foreign policy interests of the United States. Licensing of launches and reentries, operating a launch or reentry site, or some combination, is considered a federal action for which environmental impacts must be considered as part of the decision making process as required by NEPA.

Alaska Aerospace Development Corporation (AADC) applied for and was granted a launch site operator license for the operation of KLC in September 1998. A license to operate a launch site remains in effect for 5 years from the date of issuance unless surrendered, suspended, or revoked before the expiration of the term and is renewable upon application by the licensee (14 CFR 420.43). The existing FAA license for the operation of KLC will expire in September 2003.

Should the FAA not reissue a launch site operator's license for KLC to conduct launches, the MDA would be required to choose an alternative that does not include KLC. KLC is the only launch complex evaluated in the EIS that requires a license from the FAA.

An environmental review is just one component of the FAA's licensing process. FAA Order 1050.1D (*Polices and Procedures for Considering Environmental Impacts*) describes the Agency's procedures for implementing NEPA. Specifically, it requires that the FAA decision making process facilitate public involvement by including consideration of the effects of the Proposed Action and alternatives; avoidance or minimization of adverse effects attributable to

the Proposed Action; restoration and enhancement of resources, and environmental quality of the nation. These requirements will be considered in the FAA's licensing decision.

In addition to the environmental review and determination, applicants must complete a policy review and approval, safety review and approval, payload review and determination, and a financial responsibility determination. The purpose of the Policy Review and Approval process is to determine whether or not the information in the license application presents any issues affecting U.S. national security or foreign policy interests, or international obligations of the United States. The purpose of the Safety Review and Approval process is to determine whether an applicant can safely conduct the launch of the proposed launch vehicle(s) and any payload. The purpose of the Payload Review and Determination is to determine whether a license applicant or payload owner or operator has obtained all required licenses, authorization, and permits. The purpose of the Financial Responsibility Determination is to ensure that all commercial licensees demonstrate financial responsibility to compensate for the maximum probable loss from claims by a third party for death, bodily injury, or property damage or loss resulting from an activity carried out under the license; and the U.S. Government against a person for damage or loss to government property resulting from an activity carried out under the license. All of these reviews, including the environmental review, must be completed prior to issuing a license. All FAA safety analyses would be conducted separately and would be included in the terms and conditions of the license.

A license to operate a launch site authorizes a licensee to offer its launch site to a launch operator for each launch point for the type and weight class of launch vehicle identified in the license application and upon which the licensing determination is based. Issuance of a license to operate a launch site does not relieve a licensee of its obligation to comply with any other laws or regulations, nor does it confer any proprietary, property, or exclusive right in the use of airspace or outer space (14 CFR 420.41).

## **ES1.8 SCOPE OF THE ENVIRONMENTAL IMPACT STATEMENT**

The GMD testing would be of two types: (1) validation of the GMD operational concept and (2) more robust GMD element testing. The facilities and operations to validate the GMD operational concept, and improve the realism of GMD element testing, are each a part of the GMD Test Bed. Each part of the test bed, however, serves a different test function and has independent utility, purpose, and need. The independent parts of the test bed also have different implementation schedules. Consequently, the independent parts of the test bed are being evaluated in separate NEPA analyses. Validation of the operational concept is analyzed in the GMD Validation of Operational Concept Environmental Assessment (EA). These actions are designed to validate potential non-launch activities associated with the GMD operational concept by testing the interoperability of the GMD components in a realistic environment. The EA analyzed construction, testing, and support activities at Fort Greely, Clear Air Force Station, and Eielson AFB in central Alaska; Eareckson Air Station on Shemya, Alaska; and Beale AFB, California.

The second type of GMD testing, which is analyzed in this EIS, would involve more robust interceptor flight tests with participation of other GMD components such as an SBX and IDTs to achieve more realistic testing. This enhanced ETR flight testing would be accomplished through

the extension of existing Pacific Region test range areas that are currently supporting GMD test activities. By extending these test range areas, the realism of GMD testing would be increased through the use of multiple missile engagement scenarios, trajectories, geometries, distances, and speeds of targets and interceptors that more closely resemble those for which an operational system would provide an effective defense. Most tests would include the launch of a target missile; tracking by range and other land-based, sea-based, airborne, and space-based sensors; launch of a GBI; and missile intercepts at high altitudes over the Pacific Ocean. Some test events proposed for later in the program would require multiple target and interceptor missile flights to validate GMD element performance.

## **ES1.9 SCOPING PROCESS**

The CEQ Regulations implementing NEPA require an open process for determining the scope of issues related to the Proposed Action and its alternatives. Comments and questions received, as a result of this process, assist the DoD in identifying potential concerns and environmental impacts to the human and natural environment.

The GMD ETR EIS public scoping period began on 28 March 2002, when the Notice of Intent to prepare an EIS was published in the *Federal Register*. The scoping comment period was originally scheduled to end on 10 May 2002, but was extended to 20 May 2002 in response to public request. Subsequently, inclusion of the SBX in the EIS analysis extended scoping and the comment period even further, through 20 December 2002.

A number of methods were used to inform the public about the GMD ETR Program and of the locations of the scheduled scoping meetings. These included:

- The Notice of Intent announcement in the *Federal Register*
- Paid advertisements in local and regional newspapers

Public scoping meetings were held at eight locations where communities could be affected by the GMD ETR program. During these public scoping meetings, attendees were invited to ask questions and make comments to the program representatives at each meeting. In addition, written comments were received from the public and regulatory agencies at the scoping meeting, and by letter and e-mail during the extended comment period. Comments received from the public and agencies pertaining to specific resource areas and locations were considered, and more detailed analysis provided in the EIS. Those comments received from the public concerning DoD policy and program issues are outside the scope of what is required to be analyzed in an EIS.

## **ES1.10 SUMMARY OF THE DRAFT ENVIRONMENTAL IMPACT STATEMENT PUBLIC REVIEW PROCESS**

The public review and comment period began with the publication of a Notice of Availability (NOA) for the GMD ETR Draft EIS, published in the *Federal Register* on Friday, 7 February 2003, by the MDA and the FAA. This initiated a review period for the public and interested agencies to review the Draft EIS and submit their comments. Copies of the Draft EIS were made available for review on the MDA web site and in local libraries in the areas affected and were provided to those who requested a copy of the EIS.

In addition to the Draft EIS review process, seven public hearings were held from 24 February 2003 to 6 March 2003. Detailed information on locations and times for each of the public hearings was published in local and regional newspapers 2 weeks in advance, and public-service announcements and press releases were provided to radio and television stations. A total of 255 people attended the public hearings. Chapter 8.0 of the EIS contains a reproduction of all comments and responses to those comments. Comment sources include transcripts of the public hearings, oral comments, electronic mail, and written comments.

## **ES1.11 METHODOLOGY OF THE ENVIRONMENTAL IMPACT STATEMENT**

To assess the significance of any impact, a list of activities necessary to accomplish the Proposed Action was developed. The affected environment at all applicable locations was then described. Next, those activities with the potential for environmental consequences were identified.

Fourteen broad areas of environmental consideration were considered to provide a context for understanding the potential effects of the Proposed Action and to provide a basis for assessing the severity of potential impacts. These areas included air quality, airspace, biological resources, cultural resources, geology and soils, hazardous materials and hazardous waste, health and safety, land use, noise, socioeconomics, transportation, utilities, visual and aesthetic resources, and water resources. Subsistence resources were also considered for potential sites in Alaska. Environmental justice is discussed separately.

## **ES1.12 SUMMARY OF ENVIRONMENTAL IMPACTS**

This section summarizes the conclusions of the analyses made for each of the areas of environmental consideration based on the application of the described methodology. Only those activities for which a potential environmental concern was determined at each candidate location are described for the No Action Alternative and Alternatives 1, 2, and 3. Tables ES-1 through ES-12 include a description of all potential impacts and mitigation measures.

## **ES1.12.1 NO ACTION ALTERNATIVE**

### **Kodiak Launch Complex**

#### *Land Use*

AADC applied for and was granted a launch site operator license for the operation of KLC in September 1998. A license to operate a launch site remains in effect for 5 years from the date of issuance unless surrendered, suspended, or revoked before the expiration of the term and is renewable upon application by the licensee (14 CFR 420.43). The existing FAA license for the operation of KLC will expire in September 2003.

If the FAA renews the launch site operator's license, the AADC would continue launching various commercial and military launch vehicles from KLC. The current operating license allows up to nine launches per year. However, AADC has estimated that approximately five missiles would be launched per year from KLC.

After September 2003, the FAA's No Action Alternative would be the nonrenewal of the AADC's launch site operator license that permits them to operate KLC for the purposes of conducting launches. KLC would no longer be licensed by the FAA to conduct launches. In the absence of any other arrangement, launch activity at KLC would be discontinued. The AADC currently holds a 30-year renewable interagency land management assignment from the Alaska Division of Land. If launch activity were discontinued at KLC, AADC would coordinate with the state to determine a proposed future use for the land. The facilities and equipment at the site could be used for other government purposes or handled as government surplus (e.g., sold). The lands on Kodiak Island at Narrow Cape have previously been considered for other development activities such as prisons, schools, and other facilities. The site is located on one of the few improved roads on the Island, and may be available for development for other purposes if AADC were no longer licensed to conduct launches.

## **ES1.12.2 PROPOSED ACTION ALTERNATIVE 1**

### **Kodiak Launch Complex**

#### *Air Quality*

There would be an increase in air pollutant emissions from construction of the GBI, target, IDT, and sensor elements of the GMD ETR at KLC. The majority of the ground disturbance would be completed in approximately 15 months. Construction emissions vary from day to day and activity to activity, with each activity having its own potential to release emissions. Because of the variability in timing and intensity of construction, estimating construction-phase pollutant emissions is difficult. Nevertheless, it is assumed that there would be particulate matter with an aerodynamic diameter of less than or equal to 10 micrometers (PM-10), impacts from ground disturbance and other pollutants (carbon monoxide, oxides of nitrogen, volatile organic compounds, and oxides of sulfur) primarily emitted from construction equipment exhaust and construction worker commuting. Once construction ceased, air quality would return to its former level.

The *de minimis* thresholds are federal limits listed in 40 CFR 51.583(b)(1). Federal actions with emissions below the *de minimis* levels are presumed to conform, that is, not cause or contribute to new violations of National Ambient Air Quality Standards (NAAQS), in areas that are in non-attainment. For the least severe nonattainment areas, the *de minimis* level for each criteria

pollutant (and their precursors, in the case of ozone) is 90.7 metric tons (100 tons) per year. Construction emission levels at KLC would be well below the *de minimis* levels, and since the area is currently in attainment for all federal standards, it is anticipated that the proposed construction and commuting emissions would not cause exceedances of the NAAQS or Alaska Ambient Air Quality Standards (AAQS) and would not have a long-term impact to air quality in the area.

The yearly generator and commuting emissions from the Proposed Action would also be below the 90.7-metric-ton (100-ton) per year criteria pollutant federal *de minimis* levels that would apply to a non-attainment area. As KLC is in attainment for all criteria pollutants, it is anticipated that the proposed commuting and generator operations would not cause exceedances of the NAAQS or Alaska AAQS. Use of these generators would however require an amendment to the existing Pre-approved Limit Permit for KLC.

The primary exhaust products of the GBI booster are hydrogen chloride, aluminum oxide, chlorine, carbon monoxide, carbon dioxide, hydrogen, nitrogen, oxygen, and water. The federal *de minimis* threshold limits were used to compare oxides of nitrogen and carbon monoxide. In the event the 5 GBIs were launched in a year, the conservatively estimated annual emissions for oxides of nitrogen were determined to be 31.8 tons, below the 100 tons standard. Carbon monoxide was calculated at 5.4 tons for 5 launches, which is well below the 100 tons annual standard. Dual target and dual GBI launches were analyzed using the Open Burn/Open Detonation Dispersion Model to determine exhaust emissions of aluminum oxide, hydrogen chloride, and carbon monoxide. The results of the modeling show that concentrations produced by dual launches of a GBI would remain within NAAQS, Alaska AAQS, and U.S. Air Force standards. The results of modeling a dual Peacekeeper target show that the level of hydrogen chloride would be below the 1-hour Air Force standard, but would exceed the peak hydrogen chloride standard for a short duration. Other emissions were determined to be within NAAQS and Alaska AAQS standards. The nominal launch of a single Peacekeeper Target is anticipated to remain within NAAQS, Alaska AAQS, and Air Force standards as fewer emissions would be released with a single launch.

The KLC EA indicated no significant impacts to air quality as a result of nine annual launches and that impacts would not accumulate with multiple launches. It is not likely that the Proposed Action of up to five launches (GBI and target) in conjunction with other currently planned or anticipated launches at KLC would exceed nine launches per year. Overall impacts to regional air quality are not expected to be adverse and would remain within NAAQS and state AAQS. Due to the limited industrialization of Kodiak Island and the surrounding environment, the potential cumulative impacts to air quality due to the proposed interceptor and target facility construction and launches would not be substantial.

### *Biological Resources*

No significant impacts to vegetation are anticipated, since new GBI, target, IDT, and sensor-related construction activities would occur mainly in upland areas of hairgrass-mixed forb meadow, one of the predominant vegetation types at KLC. This loss of vegetation (approximately 26 hectares [64.2 acres]) would represent less than two percent of the total vegetation available within KLC boundaries. No federally proposed or listed candidate, threatened, or endangered species are located within the boundaries of KLC. The Steller sea lion (*Eumetopias jubatus*) population near Kodiak Island was included in the population classified as endangered in 1997. The closest Steller sea lion haulout area, approximately 5

kilometers (3 miles) away on Ugak Island, would not be affected by site preparation noise. No Steller sea lion rookeries have been identified in the ROI.

Federally threatened Steller's eiders and endangered short-tailed albatross offshore would also be outside the range of site preparation noise levels and are not anticipated to be affected. Construction of the GBI launch silos and perimeter fencing around the launch area could disturb approximately 0.6 hectare (1.6 acres) of palustrine, emergent, persistent, seasonally flooded wetlands and 0.2 hectare (0.4 acre) of palustrine, scrub/shrub, broad-leaved deciduous, saturated wetlands. Indirect disturbance to wetlands would be minimized by implementing appropriate AADC Best Management Practices for soil erosion control to control runoff. Normal GBI and target launch activities are not expected to significantly impact vegetation. Disturbance to wildlife from the GBI and target launches would be brief and is not expected to have a lasting impact nor a measurable negative effect. The proposed missile launches would be infrequent, up to five per year over a period of 10 years.

#### *Hazardous Materials and Hazardous Waste*

The construction of the GBI, target, IDT, and sensor-related facilities would use construction-related hazardous materials. The hazardous materials that are expected to be used are common to construction activities and may include diesel fuel, anti-freeze, hydraulic fluid, lubricating oils, welding gases, and small amounts of paints, thinners, and adhesives.

Hazardous materials management techniques would be used during the construction period to minimize the amount of hazardous materials stored, the threat of their accidental and unplanned release into the environment, and the quantity of hazardous waste generated. Therefore, substantial impacts to the environment are not expected from the presence of potentially hazardous materials and the generation of wastes during the proposed action construction activities. Missile components would be transported to KLC for temporary storage, pre-launch assembly and checkout, and launch preparation in accordance with Department of Transportation (DOT) requirements. The hazardous materials contained within the missiles include solid propellant for the missile boosters and a form of monomethyl hydrazine liquid fuel and nitrogen tetroxide oxidizer for the GBI Exoatmospheric Kill Vehicle. No onsite fueling of the GBI would occur; therefore, the likelihood of release and environmental effect would be small. Small amounts of potentially hazardous and non-hazardous wastes are expected to be generated during launch operations. Wastes would be segregated as nonhazardous, hazardous, and possibly special wastes for collection and disposal in accordance with applicable state and federal requirements. Hazardous waste would be containerized and properly disposed of by individual contractors in accordance with Alaska Administrative Code, Title 18 - Environmental Conservation, Chapter 16 and KLC requirements. Only licensed hazardous waste transporters would transport hazardous wastes offsite. No permitted hazardous waste treatment or disposal facilities exist on Kodiak Island, therefore, all hazardous waste would be transferred by licensed hazardous waste transporters to the mainland for appropriate treatment or disposal.

The volume of nonhazardous, construction generated waste is expected to be small based on past experience. Nonhazardous waste would be removed by individual contractors for appropriate disposal at the Kodiak Island Borough landfill or at a landfill on the Alaska mainland.



### *Health and Safety*

All new construction or structure modification would be accomplished using the same procedures that AADC used to construct the present KLC infrastructure. Restricted public access to the immediate construction site would be ensured through use of signs and fencing. A health and safety plan would be prepared by the contractor and submitted to AADC to ensure the health and safety of onsite workers.

Prelaunch activities would include transportation of boosters, liquid fuel, and liquid oxidizer tanks for the Exoatmospheric Kill Vehicle and missile preparation, assembly, and integration testing. All components and equipment would be handled and shipped in accordance with applicable military, state, and DOT regulations. Missile components would be packaged in shipping containers designed according to Alaska, DOT, and military requirements for protection of missile components and reduction of fire/explosion or risk of hazardous materials release in the event of an accident. The boosters would be processed and prepared for launch in the same manner as previous and ongoing missile launches from KLC. The major system components (boosters, in-flight destruct package, range safety equipment and missile instrumentation) would be assembled and tested in the Integration and Processing Facility. All preparation activities would be conducted in accordance with applicable safety regulations and operations plans.

Before each launch at KLC, the Range Integrator and the KLC Safety Officer must approve all flight plans, trajectories, and planned impact areas. The KLC Safety Officer would issue range clearance and surveillance for the Launch Hazard Area and flight safety corridor. The KLC Safety Officer would establish the safety zones around the launch site and along the missile flight path no less than 4 hours before each launch. Official notifications to airmen and mariners would be used to identify the areas to be cleared. The KLC Safety Officer would then ensure the safety zone is verified clear of non-mission essential personnel and vessels out to the territorial limit approximately 20 minutes before launch.

### *Water Resources*

AADC Best Management Practices and other standard operating procedures would be used during construction and operational activities to minimize erosion and other types of impacts that could reduce the quality of affected water resources. Standard operating procedures related to the handling, disposal, recycling, and other use of hazardous materials and wastes would be followed, including spill prevention, containment, and control measures while transporting equipment and materials. The GBI and Target missiles launched from KLC would disperse certain exhaust emission products over a large area. The primary emission products of concern from a water quality-standpoint are hydrogen chloride and aluminum oxide. These emissions are not expected to cause a significant water quality impact. Environmental monitoring was required as part of the KLC launch site operator license and called for the monitoring of at least the first five launches from KLC. As summarized in *Summary Findings of KLC Environmental Monitoring Studies 1998-2001*, water quality sampling and analysis indicate there have been no discernable effects on water chemistry from KLC launches to date. Water quality was sampled before and after KLC launches, including pH level, total aluminum, and perchlorate concentration (U.S. Environmental Protection Agency method 314.0 for water).

## Vandenberg Air Force Base

### *Air Quality*

The proposed target missiles would contain less solid rocket fuel capacity than previously analyzed Titan IV, Delta II, Atlas V, and Delta IV missiles; therefore, it is anticipated they would produce lower exhaust emissions. Dual Peacekeeper target launches were analyzed using the Open Burn/Open Detonation Dispersion Model to determine exhaust emissions of aluminum oxide, hydrogen chloride, and carbon monoxide. The results of the modeling show that the level of hydrogen chloride would be below the 1-hour Air Force standard, but would exceed the peak hydrogen chloride standard for a short duration. Emission levels for both carbon monoxide and aluminum oxide were determined to be within NAAQS and California AAQS. The nominal launch of a single Peacekeeper Target is anticipated to remain within NAAQS, California AAQS, and Air Force standards as fewer emissions would be released with a single launch.

The *de minimis* thresholds are federal limits listed in 40 CFR 51.583(b)(1). Federal actions with emissions below the *de minimis* levels are presumed to conform, that is, not cause or contribute to new violations of NAAQS, in areas that are in non-attainment. For the Vandenberg AFB area, the *de minimis* levels for volatile organic compounds and nitrogen oxide are 45 metric tons (50 tons) per year, and the levels for carbon monoxide, oxides of sulfur, and PM-10 are 90.7 metric tons (100 tons). In the event that five Peacekeeper Targets are launched in a year, the conservatively estimated annual emissions for oxides of nitrogen would total 18.3 metric tons (20.2 tons), below the 45-metric-ton (50-ton) limit. Carbon monoxide was calculated to be 48.8 metric tons (53.8 tons), also below the federal limit of 90.7 metric tons (100 tons).

Previous modeling performed in the Supplemental EELV EIS, analyzed the Delta IV, a slightly larger launch vehicle than the proposed Peacekeeper Target. In the EELV EIS, predicted levels of carbon monoxide and oxides of nitrogen for the Delta IV were determined to be within the NAAQS and California AAQS acceptable levels. It is anticipated that the proposed Peacekeeper Target would also be within the NAAQS and California AAQS.

The review of the proposed action as required by the General Conformity Rule resulted in a finding of presumed conformity to the State Implementation Plan. Total foreseeable direct and indirect emissions caused by the proposed action would be both less than the mandated *de minimis* thresholds and less than 10 percent of the established Santa Barbara County Air Pollution Control District (SBCAPCD) budget. The Determination of Non-Applicability is included as appendix J of the EIS.

### *Biological Resources*

Minor modifications to existing launch facilities would result in little to no ground disturbance, minimizing impacts to vegetation. Launch exhaust products would include hydrogen chloride, aluminum oxide, carbon monoxide, nitrogen dioxide, carbon dioxide, water, and chlorine. Nominal launch activities during dry conditions could result in the deposition of very small amounts of aluminum oxide from missile exhaust. Most of the aluminum oxide would be suspended in air and dispersed over extremely large areas; the amount deposited in surface waters would have no adverse effect. The primary potential for impacts to wildlife would be from the noise created during the proposed missile launches. Disturbance to wildlife from the launches would be brief and is not expected to have a lasting impact nor a measurable negative effect on migratory bird populations. Waterfowl would quickly resume feeding and other normal behavior patterns after a launch is completed.

### *Cultural Resources*

Minor modifications to existing launch facilities would result in little to no ground disturbance. Potential effects could result from this debris striking the ground where surface or subsurface archaeological deposits or other cultural resources are located resulting in soil contamination, fire, and/or resource damage, which would all require a reparation effort. These efforts would be coordinated with applicable range representatives and agencies to develop appropriate mitigation measures to avoid impact to sensitive resources and to restore natural areas as necessary.

Several of the facilities proposed for refurbishment and reuse are eligible for listing on the National Register of Historic Places. Prior to the reuse of these facilities, consultation would occur with the State Historic Preservation Officer to ensure the protection of, or appropriate mitigation for these facilities.

### *Land Use*

Maximum use would be made of Vandenberg AFB's existing infrastructure and facilities. Minor facility modifications would be necessary under this alternative. Activities would be accomplished at an existing locale for such use and would not produce an adverse impact involving land use.

Planning and execution of launches would be in compliance with federal, state, local, and range land use requirements. Proposed activities would be compatible with the coastal consistency requirements. Closures of recreational areas and adjacent parks would continue during periods of hazardous operation. To minimize potential land use conflicts, coastline, beach, and recreational area availability would continue to be made known to the public through various local media sources.

### **Pearl Harbor, Reagan Test Site, Port Hueneme, Naval Station Everett, Port Adak, Port of Valdez**

Potential impacts of SBX operations at these locations would be similar as described below, and would apply to Alternatives 1, 2, and 3.

### *Airspace, Health and Safety*

Unrestricted operation of the SBX at the mooring location would have the potential to adversely affect air operations. However, in order to avoid or minimize adverse effects from electromagnetic radiation/electromagnetic interference, DoD has established a coordination process with responsible agencies and airspace users. A full electromagnetic radiation/electromagnetic interference survey and analysis is being conducted by the Joint Spectrum Center, in coordination with the FAA, DOT, and other potentially affected users. The survey would be used in preparing a DD Form 1494 (Application for Equipment Frequency Allocation) that is required as part of the spectrum certification and frequency allocation process. The completed DD Form 1494 that has been processed and approved by the appropriate national and international authorities would be required prior to SBX testing. The results of the survey would also be used to define the safe operating area for the SBX (acceptable azimuths and operating angles). This operating area would not interfere with airspace operations and would allow for a safe operating environment.

## **ES1.12.3 PROPOSED ACTION ALTERNATIVE 2**

### **Kodiak Launch Complex**

*Air Quality, Biological Resources, Hazardous Material and Hazardous Wastes, Health and Safety, and Water Resources*

Impacts would be similar to Alternative 1, with approximately 25 percent less area disturbed during construction. There would be no construction or operations related to GBI launches and their associated support equipment including IDT.

### **Vandenberg Air Force Base**

*Air Quality*

Under Alternative 2, GBI and target missiles would be launched from Vandenberg AFB. The GBI exhaust emissions are approximately one third as much as the Peacekeeper emissions. Impacts from GBI launches would therefore be similar to but less than those described for Alternative 1.

IDT construction would disturb approximately 5.9 hectares (14.6 acres) and would last approximately 7 months. Emissions would include PM-10 from ground disturbance and other pollutants (carbon monoxide, oxides of nitrogen, volatile organic compounds, and oxides of sulfur) primarily emitted from construction equipment exhaust and construction worker commuting. As Vandenberg AFB is within a non-attainment area for the California AAQS 1-hour ozone standard, exhaust emissions of nitrogen oxides and hydrocarbons would be of concern. For the Vandenberg AFB area, the *de minimis* levels for volatile organic compounds and nitrogen oxide are 45 metric tons (50 tons) per year, and the levels for carbon monoxide, oxides of sulfur, and PM-10 are 90.7 metric tons (100 tons). IDT construction and worker commuting emissions would be much less than these *de minimis* levels. Emissions would be monitored in accordance with Memorandum of Agreements between Vandenberg AFB and Santa Barbara County Air Pollution Control District.

The review of the proposed action as required by the General Conformity Rule resulted in a finding of presumed conformity to the State Implementation Plan. Total foreseeable direct and indirect emissions caused by the proposed action would be both less than the mandated *de minimis* thresholds and less than 10 percent of the established SBCAPCD budget. The Determination of Non-Applicability is included as appendix J of the EIS.

*Biological Resources*

Impacts would be similar to those described for Alternative 1; however, facility modifications would also include GBI facilities. Other impacts would be as described for Alternative 1.

*Cultural Resources*

Construction would include minor modifications to existing facilities and construction of an IDT. Several of the facilities proposed for refurbishment and reuse are eligible for inclusion on the National Register of Historic Places. Prior to the reuse of these facilities, consultation would occur with the State Historic Preservation Officer to ensure the protection of, or appropriate mitigation for these facilities. After selection of an IDT site from the six alternative locations, records on file at Vandenberg AFB would be consulted to determine whether cultural sites have been identified at this location. Should cultural resources be found during the course of any

GMD ETR activity, all activities would cease in the area and the proper authorities would be notified. Subsequent actions would follow the guidance provided. The GMD Project Office would be responsible for implementation of any cultural resources avoidance or mitigation measures assigned to this project as a condition of approval for proceeding with any proposed activity.

Flight activity impacts would be similar to those described for Alternative 1.

#### *Land Use*

Impacts would be as described for Alternative 1. Proposed activities would be in accordance with coastal consistency requirements.

#### *Water Resources*

Construction of an IDT under Alternative 2 would disturb approximately 5.9 hectares (14.6 acres) at Vandenberg AFB. Construction projects that disturb 1 acre or greater require a Construction Activities Storm Water General Permit from the California State Water Resources Control Board, or its local Central Coast Regional Water Quality Control Board. A related Stormwater Pollution Prevention Plan would also need to be prepared before the commencement of any soil-disturbing activities. All appropriate water quality-related Best Management Practices would be followed during construction, and related water quality impacts would not be significant. Operation of the IDT would not cause water quality impacts and potable water supplies are sufficient to handle the minor increase in potable water demand.

### **ES1.12.4 PROPOSED ACTION ALTERNATIVE 3**

Potential environmental impacts of activities in Alternative 3 would be as described for Alternatives 1 and 2. This would include GBI launches from KLC, Reagan Test Site, and Vandenberg AFB, and construction or modification of the required support facilities for dual launches of GBI and target missiles at each location. Impacts described below for the Broad Ocean Area would also apply to Alternatives 1 and 2.

#### **Broad Ocean Area**

##### *Airspace*

After launch, typically the GBI and target missiles would be above 18,290 meters (60,000 feet) within seconds of launch. As such, all other local flight activities would occur at sufficient distance and altitude that the target missile and GBI missiles would be little noticed. However, activation of stationary altitude reservation procedures, where the FAA provides separation between non-participating aircraft and the missile flight test activities, would impact the controlled airspace available for use by non-participating aircraft for the duration of the altitude reservation, usually for a matter of a few hours, with a backup day reserved for the same hours. Because the airspace in most of the intercept debris areas is not heavily used by commercial aircraft, and is far removed from the en route airways and jet routes crossing the North Pacific, the impacts to controlled/uncontrolled airspace would be minimal. However, the intercept scenarios with targets from KLC and GBIs from Vandenberg AFB may have moderate impacts to airspace due to the potential impacts from intercept debris.

The Range Commanders Council has been determined that intercept debris as small as 1 gram could cause significant damage to a commercial aircraft traveling at cruising speed and altitude. The debris cloud is approximately 35 kilometers (22 miles) in diameter, and the area where the probability of fatality is greater than one in one million is approximately 22 kilometers (13.6 miles) in diameter. This area of higher risk would need to be avoided by all aircraft. The time for the intercept debris to pass through commercial airspace cruising altitudes is approximately 3 hours after the intercept. All en route airways and jet routes that are predicted to pass through the missile intercept debris areas would need to be identified before a test to allow sufficient coordination with the FAA to determine if the aircraft on those routes would be affected, and if so, if they would need to be re-routed or rescheduled. Routing around the debris areas would be handled in a manner similar to severe weather. The additional time for commercial aircraft to avoid the area would generally be less than 5 minutes at cruising altitudes and speeds.

### *Biological Resources*

Of particular concern is the potential for impacts to marine mammals from both acoustic and non-acoustic effects. Potential acoustic effects include behavioral disturbance (including displacement), acoustic masking (elevated noise levels that drown out other noise sources), and (with very strong sounds) temporary or permanent hearing impairment. Potential non-acoustic effects include physical impact by falling debris, entanglement in debris, and contact with or ingestion of debris or hazardous materials. The missiles could generate a sonic boom upon launch or reentry. Each missile would propagate a unique sonic boom contour depending upon its mass, shape, velocity, and reentry angle, among other variables. The location of the possible impact point would vary depending upon the particular flight test profile. It is therefore difficult to produce the specific location, extent, duration, or intensity of sonic boom impacts upon marine life. These noise levels would be of very short duration. The first-, second-, and third-stage target missile boosters and the target vehicle's payload, which all fall to the ocean surface, would impart a considerable amount of kinetic energy to the ocean water upon impact. Missiles and targets would hit the water with speeds of 91 to 914 meters (300 to 3,000 feet) per second. At close ranges, injuries to internal organs and tissues would likely result. However, injury to any marine mammal by direct impact or shock wave impact would be extremely remote (less than 0.0006 marine mammals exposed per year).

Debris impact and booster drops in the Broad Ocean Area could occur within the 322-kilometer (200-mile) limit of the Exclusive Economic Zone of affected islands. The natural buffering capacity of seawater and the strong ocean currents would neutralize reaction to any release of the small amount of liquid propellant contained within the Divert and Attitude Control System or Liquid Propellant Missile. Analysis in the *Marine Mammal Technical Report*, prepared in support of the Point Mugu Sea Range EIS, determined that there is a very low probability that a marine mammal would be killed by falling missile boosters, targets, or debris as a result of tests at the Point Mugu Sea Range (less than 0.0149 marine mammals exposed per year). The potential for an object or objects dropping from the air to affect marine mammals or other marine biological resources is less than  $10^{-6}$  (1 in 1 million). The probability of a spent missile landing on a cetacean or other marine mammal is remote.

This probability calculation was based on the size of the area studied and the density of the marine mammal population in that area. The analysis concluded that the effect of this missile debris and intact missiles coming down in the open ocean would be negligible. The range area at Point Mugu is smaller (93,200 square kilometers [27,183 square nautical miles]) than the PMRF range area (144,000 square kilometers [42,000 square nautical miles]) and other open ocean areas proposed for intercepts, and the density of marine mammals in the Point Mugu Sea Range is larger than the density found in PMRF range area and the open ocean. It is reasonable to conclude that the probability of a marine mammal being injured or killed by missile or debris impact from U.S. Navy testing at PMRF and other locations in the open ocean is even more remote than at Point Mugu, since the area at PMRF is larger and the density of marine mammals is smaller. Following formal consultation, the National Marine Fisheries Service concluded that the Proposed Action is not likely to adversely affect any marine mammal species.

**Table ES-1A: Impacts and Mitigation Summary, MDA No Action Alternative**

Resource Category	MDA No Action Alternative				
	Kodiak Launch Complex	Midway	Reagan Test Site	Pacific Missile Range Facility	Vandenberg Air Force Base
<b>Air Quality</b>	Missile Defense Agency: No change to the region's current attainment status. Single target and commercial launches would continue. Federal Aviation Administration: No change to the region's current attainment. No launches would be allowed to occur.	No change to the region's current attainment status. Midway would continue to serve as a National Wildlife refuge.	No change to the region's current attainment status. Current missile activities would continue.	No change to the region's current attainment status. Current missile activities would continue.	No change to the region's current attainment status. Current missile activities would continue.
<b>Airspace</b>	Missile Defense Agency: Continued close coordination with the Federal Aviation Administration regarding missile launches would result in no change in airspace status or use. Federal Aviation Administration: No change in airspace status. No launches would be allowed to occur.	Not analyzed.	Continued close coordination with the Federal Aviation Administration regarding radar operations would result in no change in airspace status or use.	Not analyzed.	Not analyzed.
<b>Biological Resources</b>	Missile Defense Agency: Temporary effects to vegetation from emissions, discoloration and foliage loss. Temporary, short-term startle effects from noise to wildlife and birds. Although a remote possibility, individual animals close to the water's surface could be hit by debris. Federal Aviation Administration: No impact to biological resources as no launches would be allowed to occur.	No impact.	Temporary effects to vegetation from emissions, discoloration and foliage loss. Temporary, short-term startle effects from noise to wildlife and birds. Although a remote possibility, individual animals close to the water's surface could be hit by debris. Personnel would be instructed to avoid areas designated as avian or sea turtle nesting or avian roosting habitat and to avoid all contact with any nest that may be encountered.	Short-term disturbance to wildlife, including migratory birds, from minor site preparation activities and increased personnel. Reflection from outdoor lighting could disorient the Newell's Townsend's shearwater. Temporary effects to vegetation from emissions, discoloration and foliage loss. Temporary, short-term startle effects from noise to wildlife and birds. Although a remote possibility, individual animals close to the water's surface could be hit by debris.	Temporary effects to vegetation from emissions, discoloration and foliage loss. Temporary, short-term startle effects from noise to wildlife and birds. Although a remote possibility, individual animals close to the water's surface could be hit by debris.
<b>Cultural Resources</b>	Missile Defense Agency: No impact to cultural resources from continued operations. Federal Aviation Administration: No impact to cultural resources as no launches would be allowed to occur.	Not analyzed.	Not analyzed.	Not analyzed.	Resources would continue to be managed in accordance with cultural resources regulations.



**Table ES-1A: Impacts and Mitigation Summary, MDA No Action Alternative (Continued)**

Resource Category	MDA No Action Alternative				
	Kodiak Launch Complex	Midway	Reagan Test Site	Pacific Missile Range Facility	Vandenberg Air Force Base
<b>Geology and Soils</b>	Missile Defense Agency: Maintenance and improvement construction activities would cause minor soil erosion. No adverse changes to soil chemistry are predicted to occur as a result of missile launch exhaust emissions. Federal Aviation Administration: No impact to geology or soils. No launches would be allowed to occur.	Not analyzed.	Not analyzed.	Not analyzed.	No adverse changes to soil chemistry are predicted to occur as a result of ongoing missile launch exhaust emissions.
<b>Hazardous Materials and Hazardous Waste</b>	Missile Defense Agency: Continued handling and use of limited quantities of hazardous and toxic materials related to pre-launch, launch and post-launch activities would generate small quantities of hazardous waste. The use and disposal of hazardous materials and wastes would be in accordance with Kodiak Launch Complex, State of Alaska, Environmental Protection Agency, Occupational Safety and Health Administration, Department of Transportation, and Department of Defense policies and procedures. Federal Aviation Administration: No impact. No launches would be allowed to occur.	As described in previous National Environmental Policy Act documentation, impact would be minimal.	Continued handling and use of limited quantities of hazardous and toxic materials related to pre-launch, launch and post-launch activities would generate small quantities of hazardous waste. The use and disposal of hazardous materials and wastes would be in accordance with the U.S. Army Kwajalein Atoll Environmental Standards.	Continued handling and use of limited quantities of hazardous and toxic materials related to pre-launch, launch and post-launch activities would generate small quantities of hazardous waste. The use and disposal of hazardous materials and wastes would be in accordance with Pacific Missile Range Facility, State of Hawaii, Environmental Protection Agency, Occupational Safety and Health Administration, Department of Transportation, and Department of Defense policies and procedures.	Continued handling and use of limited quantities of hazardous and toxic materials related to pre-launch, launch and post-launch activities would generate small quantities of hazardous waste. The use and disposal of hazardous materials and wastes would be in accordance with Vandenberg Air Force Base, State of California, Environmental Protection Agency, Occupational Safety and Health Administration, Department of Transportation, and Department of Defense policies and procedures.
<b>Health and Safety</b>	Missile Defense Agency: Planning and execution of target launches would continue. Ground and Launch Hazard Areas, Notices to Airmen and Notices to Mariners, and program Safety plans would protect workers and the general public. Compliance with federal, state, and local health and safety requirements and regulations, as well as Department of Defense and Kodiak Launch Complex Safety Policy would result in no impacts to health and safety. Federal Aviation Administration: No impact. No launches would be allowed to occur.	Not analyzed.	Planning and execution of target and Ground-Based Interceptor launches would continue. Compliance with Reagan Test Site standards and procedures ensure that potential risks to the general public, workers, and the launch areas do not exceed Range Commanders Council Standard 321-02 criteria, and there would be no impact to health and safety.	Planning and execution of target launches would continue. Ground and Launch Hazard Areas, Notices to Airmen and Notices to Mariners, and implementation of Safety plans would protect workers and the general public. Compliance with federal, state, and local health and safety requirements and regulations, as well as Department of Defense and Pacific Missile Range Facility Safety Policy would result in no impacts to health and safety.	Planning and execution of target and Ground-Based Interceptor launches would continue. Ground and Launch Hazard Areas, Notices to Airmen and Notices to Mariners, and implementation of Safety plans would protect workers and the general public. Compliance with federal, state, local and Vandenberg Air Force Base health and safety requirements ensure there is no increase in risk to workers and the general public.

**Table ES-1A: Impacts and Mitigation Summary, MDA No Action Alternative (Continued)**

Resource Category	MDA No Action Alternative				
	Kodiak Launch Complex	Midway	Reagan Test Site	Pacific Missile Range Facility	Vandenberg Air Force Base
<b>Land Use</b>	Missile Defense Agency: Continued publication of availability of Kodiak Launch Complex's beaches and coastline.  Federal Aviation Administration: No impact to land use as no launches would be allowed to occur.	Not analyzed.	Not analyzed.	Not analyzed.	No impact. As described in previous National Environmental Policy Act documentation, Vandenberg Air Force Base publicizes recreation availability and activities are consistent with the California Coastal Zone Management Program.
<b>Noise</b>	Missile Defense Agency: No adverse impact. Infrequent noise associated with target and commercial launches would continue to be audible for short periods of time.  Federal Aviation Administration: No impact. No launches would be allowed to occur.	Not analyzed.	Not analyzed.	Not analyzed.	No adverse impact. Infrequent noise associated with planned missile launches would continue.
<b>Socioeconomics</b>	Missile Defense Agency: No impact.  Federal Aviation Administration: Any economic benefits to the Kodiak Island Borough from the periodic presence of launch-related personnel would not occur.	Not analyzed.	Not analyzed.	Though limited in scope, continued target missile launches would have a positive effect on the local economy of the island.	No impact.
<b>Transportation</b>	Missile Defense Agency: No change to current level of service on roadways.  Federal Aviation Administration: No impact. No launches would be allowed to occur.	Not analyzed.	Not analyzed.	Not analyzed.	No change to current level of service on roadways.
<b>Utilities</b>	Missile Defense Agency: Electricity demand, potable water consumption, wastewater usage, and solid waste disposal would be handled by existing facilities.  Federal Aviation Administration: No impact. No launches would be allowed to occur.	Not analyzed.	No impacts.	Not analyzed.	Any increase in electricity demand, potable water consumption, wastewater usage, and solid waste disposal would be handled by existing facilities.

**Table ES-1A: Impacts and Mitigation Summary, MDA No Action Alternative (Continued)**

Resource Category	MDA No Action Alternative				
	Kodiak Launch Complex	Midway	Reagan Test Site	Pacific Missile Range Facility	Vandenberg Air Force Base
<b>Visual and Aesthetic Resources</b>	Missile Defense Agency: No impact. No construction of new structures or infrastructure is planned.  Federal Aviation Administration: No impact. No launches would be allowed to occur.	Not analyzed.	Not analyzed.	Not analyzed.	No construction of new structures or infrastructure is planned.
<b>Water Resources</b>	Missile Defense Agency: Minor potential for short-term increase in erosion and turbidity of surface waters during construction. Missile launches would disperse exhaust emission products over a large area. These emissions would not cause a significant water quality impact. Water quality monitoring would continue on an as-needed basis.  Federal Aviation Administration: No impact to water resources as no launches would be allowed to occur.	Not analyzed.	Not analyzed.	Not analyzed.	Missile launches would disperse exhaust emission products over a large area. Previous studies concluded that water quality impacts would be adverse but not significant.
<b>Environmental Justice</b>	Missile Defense Agency: No impact. No low-income or minority populations would be disproportionately affected.  Federal Aviation Administration: No impact. No launches would be allowed to occur.	Not analyzed.	Not analyzed.	Not analyzed.	Not analyzed.
<b>Subsistence</b>	Missile Defense Agency: No impact to subsistence uses in and around Kodiak Launch Complex.  Federal Aviation Administration: Positive impact. There would be no closure of areas to subsistence harvesting as no launches would be allowed to occur.	Not applicable.	Not applicable.	Not applicable.	Not applicable.

**Table ES-1B: Impacts and Mitigation Summary, MDA No Action Alternative**

Resource Category	MDA No Action Alternative					
	Pearl Harbor	Naval Base Ventura County Port Hueneme	Naval Station Everett	Port Adak	Port of Valdez	Broad Ocean Area
<b>Air Quality</b>	No change to the region's current attainment status.	No change to the region's current attainment status.	No change to the region's current attainment status.	No change to the region's current attainment status.	No change to the region's current attainment status.	Not analyzed.
<b>Airspace</b>	Continuing activities would not conflict with airspace use plans, policies or controls.	Continuing activities would not conflict with airspace use plans, policies or controls.	Continuing activities would not conflict with airspace use plans, policies or controls.	Continuing activities would not conflict with airspace use plans, policies or controls.	Continuing activities would not conflict with airspace use plans, policies or controls.	Continuing activities would not conflict with airspace use plans, policies or controls.
<b>Biological Resources</b>	Ongoing activities would not impact biological resources.	Ongoing activities would not impact biological resources.	Ongoing activities would not impact biological resources.	Ongoing activities would not impact biological resources.	Ongoing activities would not impact biological resources.	No adverse impact.
<b>Hazardous Materials and Hazardous Waste</b>	No change in the use and disposal of hazardous materials and wastes currently occurring at Pearl Harbor.	No change in the use and disposal of hazardous materials and wastes currently occurring at Naval Base Ventura County Port Hueneme.	No change in the use and disposal of hazardous materials and wastes currently occurring at Naval Station Everett.	No change in the use and disposal of hazardous materials and wastes currently occurring at Port Adak.	No change in the use and disposal of hazardous materials and wastes currently occurring at Port of Valdez.	Not analyzed.
<b>Health and Safety</b>	No change in the type of operations or health and safety plans currently implemented at Pearl Harbor.	No change in the type of operations or health and safety plans currently implemented at Naval Base Ventura County Port Hueneme.	No change in the type of operations or health and safety plans currently implemented at Naval Station Everett.	No change in the type of operations or health and safety plans currently implemented at Port Adak.	No change in the type of operations or health and safety plans currently implemented at Port of Valdez.	Ongoing missile flight test activities would continue to use the existing special use airspace and other areas in the Pacific Broad Ocean Area. The continuing activities would not conflict with commercial shipping lanes or airspace use plans, policies, and controls. Appropriate safety measures and procedures would continue to be followed.

**Table ES-1B: Impacts and Mitigation Summary, MDA No Action Alternative (Continued)**

Resource Category	MDA No Action Alternative					
	Pearl Harbor	Naval Base Ventura County Port Hueneme	Naval Station Everett	Port Adak	Port of Valdez	Broad Ocean Area
<b>Socioeconomics</b>	Not analyzed.	Not analyzed.	Operations currently conducted at Naval Station Everett would continue. No displacement of populations, residences or businesses would occur within the City of Everett or adjacent areas as a result of the No Action Alternative. The facilities would continue to be utilized as currently designated.	Not analyzed.	Not analyzed.	Not analyzed.
<b>Transportation</b>	Not analyzed.	Not analyzed.	No impacts.	Not analyzed.	No impacts.	Prior warning of launch activities would allow commercial shipping to follow alternative routes away from the test areas.
<b>Utilities</b>	Electricity demand, potable water consumption, wastewater usage, and solid waste disposal would be handled by existing facilities.	Electricity demand, potable water consumption, wastewater usage, and solid waste disposal would be handled by existing facilities.	Electricity demand, potable water consumption, wastewater usage, and solid waste disposal would be handled by existing facilities.	Electricity demand, potable water consumption, wastewater usage, and solid waste disposal would be handled by existing facilities.	Electricity demand, potable water consumption, wastewater usage, and solid waste disposal would be handled by existing facilities.	Not analyzed.
<b>Visual and Aesthetic Resources</b>	No change in the Visual setting at Pearl Harbor or offshore Barbers Point.	Not analyzed.	No change in the Visual setting at Naval Station Everett.	No change in the Visual setting at Port Adak.	No change in the Visual setting at the Port of Valdez.	Not analyzed.

**Table ES-2: Impacts and Mitigation Summary, Kodiak Launch Complex**

Resource Category	Kodiak Launch Complex			
	Ground-Based Interceptor	Target	In-Flight Interceptor Communication System Data Terminal /TPS-X Radar	Mobile Telemetry
<b>Air Quality</b>	<p>A minimal increase in air emissions from construction would not affect the region's current attainment status.</p> <p>The results of modeling to determine exhaust emissions of aluminum oxide, hydrogen chloride, and carbon monoxide show that concentrations produced by dual launches of a Ground-Based Interceptor would remain within National Ambient Air Quality Standards (NAAQS), California Ambient Air Quality Standards (AAQS), and U.S. Air Force standards. Significant air quality impacts due to Ground-Based Interceptor launches are not anticipated.</p>	<p>A minimal increase in air emissions from target construction would not affect the region's current attainment status.</p> <p>The results of modeling a dual Peacekeeper target launch to determine exhaust emissions of aluminum oxide, hydrogen chloride, and carbon monoxide show that the level of hydrogen chloride would be below the 1-hour Air Force standard, but would exceed the peak hydrogen chloride standard for a short duration. Other emissions were determined to be within NAAQS and Alaska AAQS. A single Peacekeeper target launch would be within NAAQS, Alaska AAQS, and U.S. Air Force standards. Significant air quality impacts due to target launches are not anticipated.</p>	<p>Increase in air emissions from construction and operation of the In-Flight Interceptor Communication System Data Terminal and TPS-X Radar would not affect the region's current attainment status.</p>	<p>Increase in air emissions from operation would not affect the region's current attainment status.</p>
<b>Airspace</b>	<p>The use of the required scheduling and coordination with the Federal Aviation Administration and issuance of Notices to Airmen would reduce potential impacts to airspace status or use to the level of insignificance.</p>	<p>The use of the required scheduling and coordination with the Federal Aviation Administration and issuance of Notices to Airmen would reduce potential impacts to airspace status or use to the level of insignificance.</p>	<p>Construction and operation would not impact airspace.</p>	<p>Operation would not impact airspace.</p>
<b>Biological Resources</b>	<p>Loss of small amount of mainly upland vegetation. Fence line would likely be altered to avoid impacts to wetlands. Temporary, short-term startle effects from noise to wildlife and birds. Although a remote possibility, individual animals close to the water's surface could be hit by debris.</p>	<p>Loss of small amount of mainly upland vegetation. Fence line would likely be altered to avoid impacts to wetlands. Temporary, short-term startle effects from noise to wildlife and birds. Although a remote possibility, individual animals close to the water's surface could be hit by debris.</p>	<p>Loss of small amount of mainly upland vegetation. Temporary, short-term startle effects from noise to terrestrial wildlife and birds. Short-term operational impacts to wildlife (non-listed only) from security lighting and noise from electrical generators required for the site. The TPS-X Radar is not expected to radiate lower than 5 degrees above horizontal and the relatively small radar beam would normally be in motion which reduces the probability of bird species remaining within this limited region of space.</p>	<p>Mobile sensors necessary to support Ground-Based Midcourse Defense Extended Test Range activities would be located on existing disturbed areas with minimal effect to biological resources.</p>

**Table ES-2: Impacts and Mitigation Summary, Kodiak Launch Complex (Continued)**

Resource Category	Kodiak Launch Complex			
	Ground-Based Interceptor	Target	In-Flight Interceptor Communication System Data Terminal/TPS-X Radar	Mobile Telemetry
<b>Cultural Resources</b>	No impacts are expected for the proposed action because previous archaeological surveys have not indicated that cultural resources are present within the upland areas of Kodiak Launch Complex and because project details would be submitted to the Alaska State Historic Preservation Officer for coordination.	No impacts are expected for the proposed action because previous archaeological surveys have not indicated that cultural resources are present within the upland areas of Kodiak Launch Complex and because project details would be submitted to the Alaska State Historic Preservation Officer for coordination.	No impacts are expected for the proposed action because previous archaeological surveys have not indicated that cultural resources are present within the upland areas of Kodiak Launch Complex and because project details would be submitted to the Alaska State Historic Preservation Officer for coordination.	No impacts are expected for the proposed action because the Mobile Telemetry will be established in areas that have previously been paved.
<b>Geology and Soils</b>	Final site layout and design for Extended Test Range facilities will consider available information bearing on seismic design and construction. Minor increase in soil erosion would be localized to the construction sites. No adverse changes to soil chemistry are predicted to occur as a result of missile launch exhaust emissions.	Final site layout and design for Extended Test Range facilities will consider available information bearing on seismic design and construction. Minor increase in soil erosion would be localized to the construction sites. No adverse changes to soil chemistry are predicted to occur as a result of missile launch exhaust emissions.	Final site layout and design for Extended Test Range facilities will consider available information bearing on seismic design and construction. Minor increase in soil erosion would be localized to the construction sites.	Soil disturbance from site preparation activities would be minor.
<b>Hazardous Materials and Hazardous Waste</b>	The Ground-Based Interceptor construction and launch activities would use small quantities of hazardous materials, which would result in the generation of some hazardous and non-hazardous waste that would be similar to current operations. All hazardous materials and waste would be handled in accordance with applicable state and federal regulations.	The target construction and launch activities would use small quantities of hazardous materials, which would result in the generation of some hazardous and non-hazardous waste that would be similar to current operations. All hazardous materials and waste would be handled in accordance with applicable state and federal regulations.	The construction and operation of the In-Flight Interceptor Communication System Data Terminal, and operation of the TPS-X Radar would use small quantities of hazardous materials, which would result in the generation of some hazardous and non-hazardous waste that would be similar to current launch support operations. All hazardous materials and waste would be handled and disposed of in accordance with applicable state and federal regulations.	No impact from short term operation of mobile sensors at existing gravel pad areas.

**Table ES-2: Impacts and Mitigation Summary, Kodiak Launch Complex (Continued)**

Resource Category	Kodiak Launch Complex			
	Ground-Based Interceptor	Target	In-Flight Interceptor Communication System Data Terminal	Mobile Telemetry
<b>Health and Safety</b>	<p>Planning and execution of single and dual Ground-Based Interceptor launches would include establishing ground and Launch Hazard Areas, issuing Notices to Airmen and Notices to Mariners, and adherence to program Safety plans. These actions would be in compliance with federal, state, and local health and safety requirements and regulations, as well as Department of Defense and Kodiak Launch Complex Safety Policy and would result in no impacts to health and safety.</p>	<p>Planning and execution of single and dual launches would include establishing ground and Launch Hazard Areas, issuing Notices to Airmen and Notices to Mariners, and adherence to program Safety plans. These actions would be in compliance with federal, state, and local health and safety requirements and regulations, as well as Department of Defense and Kodiak Launch Complex Safety Policy and would result in no impacts to health and safety.</p>	<p>The In-Flight Interceptor Communication System Data Terminal emissions are considered to be of sufficiently low power so that there would be no exposure hazard and no impact to health and safety. TPS-X Radar Electromagnetic Radiation hazard zones would be established within the beam's tracking space. A visual survey of the area would verify that all personnel are outside the hazard zone prior to startup. Adherence to Alaska Aerospace Development Corporation, Federal Aviation Administration, and Department of Defense safety procedures relative to radar operations would preclude significant impact to health and safety.</p>	<p>For mobile telemetry equipment, the associated radio frequency emissions are considered to be of sufficiently low power so that there is no exposure hazard.</p>
<b>Land Use</b>	<p>Minimal impacts would occur as a result of site preparation and new construction limiting the utilization of land by livestock for grazing on a minute portion of the overall land available for such activity.</p> <p>The availability of recreational opportunities at Narrow Cape would not be significantly impacted by the Ground-Based Midcourse Defense Extended Test Range activities. Only temporary closures during the transportation of missile components to the launch facilities and up to a full day closure on launch days would occur for the Pasagshak Point Road at the Kodiak Launch Complex site boundary.</p>	<p>Minimal impacts would occur as a result of site preparation and new construction limiting the utilization of land by livestock for grazing on a minute portion of the overall land available for such activity.</p> <p>The availability of recreational opportunities at Narrow Cape would not be significantly impacted by the Ground-Based Midcourse Defense Extended Test Range activities. Only temporary closures during the transportation of missile components to the launch facilities and up to a full day closure on launch days would occur for the Pasagshak Point Road at the Kodiak Launch Complex site boundary.</p>	<p>No impacts would occur as a result of site preparation and new construction limiting the utilization of land by livestock for grazing on a minute portion of overall land for the proposed locations on Kodiak Launch Complex. Of the proposed locations outside the boundaries of Kodiak Launch Complex, any change in land use would be temporary and confined to the immediate operation area with no impacts expected to occur.</p>	<p>No impact would occur as a result of the temporary site use limiting the utilization of land by livestock for grazing on a minute portion of the overall land available for such activity.</p>
<b>Noise</b>	<p>Intermittent and short-term noise due to construction and infrequent noise associated with Ground-Based Interceptor launches would be audible for only short periods of time and would not be expected to interfere with the area's fishing, camping, or other recreational uses. Dual launches of Ground-Based Interceptors would result in a minor increase in noise levels compared to a single launch.</p>	<p>Intermittent and short-term noise due to construction and infrequent noise associated with target launches would be audible for only short periods of time and would not be expected to interfere with the area's fishing, camping, or other recreational uses. Dual launches of Ground-Based Interceptors would result in a minor increase in noise levels compared to a single launch.</p>	<p>Intermittent and short-term noise due to construction would be anticipated. Operational noise would stem from use of generators to run the TPS-X Radar and emergency use for the In-Flight Interceptor Communication System Data Terminal. They would not increase the noise levels of the regional environment.</p>	<p>Intermittent and short-term noise due to operation would stem from the use of generators to operate mobile telemetry. Regional noise levels would not be increased.</p>



**Table ES-2: Impacts and Mitigation Summary, Kodiak Launch Complex (Continued)**

Resource Category	Kodiak Launch Complex			
	Ground-Based Interceptor	Target	In-Flight Interceptor Communication System Data Terminal/TPS-X Radar	Mobile Telemetry
<b>Socioeconomics</b>	<p>Construction and operations direct and indirect employment and materials expenditures would provide economic benefit to surrounding community's retail sales and tax base with no impact on public services.</p> <p>Coordination with the local tourist industry would be used to reduce the potential for impacts to tourists seeking accommodations when a launch occurs during the peak tourist season.</p> <p>Construction of an addition to the existing Narrow Cape Lodge and/or the construction of an additional mancamp at Kodiak Launch Complex would provide additional accommodations.</p>	<p>Construction and operations direct and indirect employment and materials expenditures would provide economic benefit to surrounding community's retail sales and tax base with no impact on public services.</p> <p>Coordination with the local tourist industry would be used to reduce the potential for impacts to tourists seeking accommodations when a launch occurs during the peak tourist season.</p> <p>Construction of an addition to the existing Narrow Cape Lodge and/or the construction of an additional mancamp at Kodiak Launch Complex would provide additional accommodations.</p>	<p>Personnel associated with Ground-Based Interceptor related activities would operate such systems; therefore no personnel in addition to those already involved in Ground-Based Interceptor operation would be required; furthermore no impacts would occur. Construction and operations direct and indirect employment and materials expenditures would provide economic benefit to surrounding community's retail sales and tax base with no impact on public services.</p>	<p>Personnel associated with target missile related activities would operate such systems; therefore no personnel in addition to those already involved in target operation would be required; furthermore no impacts would occur. Construction and operations direct and indirect employment and materials expenditures would provide economic benefit to surrounding community's retail sales and tax base with no impact on public services.</p>
<b>Transportation</b>	<p>Temporary traffic delays to Kodiak Launch Complex via Rezanof Drive as a result of movement of construction equipment and material would cause minimal and infrequent traffic delays.</p>	<p>Temporary traffic delays to Kodiak Launch Complex via Rezanof Drive as a result of movement of construction equipment and material would cause minimal and infrequent traffic delays.</p>	<p>No impact.</p>	<p>No impact.</p>
<b>Utilities</b>	<p>Increases in the level of electrical demand, potable water consumption, wastewater treatment services, and solid waste disposal services.</p> <p>New potable water and septic systems would be installed as required.</p>	<p>Increases in the level of electrical demand, potable water consumption, wastewater treatment services, and solid waste disposal services.</p> <p>New potable water and septic systems would be installed as required.</p>	<p>Increases in the level of electrical demand, potable water consumption, wastewater treatment services, and solid waste disposal services.</p> <p>New potable water and septic systems would be installed as required.</p>	<p>No impact.</p>
<b>Visual and Aesthetic Resources</b>	<p>Although the Narrow Cape area is being developed, there is the potential that some concerned viewers would be affected by the additional facilities. Even though the amount of concerned viewers would be somewhat limited, there is a potential for adverse affects to visual resources.</p>	<p>Although the Narrow Cape area is being developed, there is the potential that some concerned viewers would be affected by the additional facilities. Even though the amount of concerned viewers would be somewhat limited, there is a potential for adverse affects to visual resources.</p>	<p>Although the Narrow Cape area is being developed, there is the potential that some concerned viewers would be affected by the additional facilities. Even though the amount of concerned viewers would be somewhat limited, there is a potential for adverse affects to visual resources.</p>	<p>No impact.</p>

**Table ES-2: Impacts and Mitigation Summary, Kodiak Launch Complex (Continued)**

Resource Category	Kodiak Launch Complex			
	Ground-Based Interceptor	Target	In-Flight Interceptor Communication System Data Terminal/TPS-X Radar	Mobile Telemetry
<b>Water Resources</b>	Minor potential for short-term increase in erosion and turbidity of surface waters during construction. The Ground-Based Interceptor would disperse exhaust emission products over a large area. These emissions would not cause a significant water quality impact.	Minor potential for short-term increase in erosion and turbidity of surface waters during construction. The target would disperse exhaust emission products over a large area. These emissions would not cause a significant water quality impact.	Minor potential for short-term increase in erosion and turbidity of surface waters during construction.	Mobile telemetry operations would have minimal impact on water resources.
<b>Subsistence</b>	Although there is a decrease in the amount of land available for subsistence uses the Narrow Cape area hosts only a limited amount of subsistence harvesting and the entire coast from Pasagshak Bay to the southern end of the island is a harvesting area. Temporarily restricting public access during Ground-Based Midcourse Defense Extended Test Range pre-launch and launch activities would not be significant.	Although there is a decrease in the amount of land available for subsistence uses the Narrow Cape area hosts only a limited amount of subsistence harvesting and the entire coast from Pasagshak Bay to the southern end of the island is a harvesting area. Temporarily restricting public access during Ground-Based Midcourse Defense Extended Test Range pre-launch and launch activities would not be significant.	Although there is a decrease in the amount of land available for subsistence uses the potential In-Flight Interceptor Communication System Data Terminals area is not a main subsistence use area in the region.	No impact.

**Table ES-3: Impacts and Mitigation Summary, Midway**

Resource Category	Midway (Although Midway was an alternative site in the Draft EIS, MDA has determined that it is no longer a reasonable alternative and will not be a proposed site for ETR activities. The discussion of Midway has been retained in the Final EIS, however, in order to preserve the work that has already been performed.)	
	In-Flight Interceptor Communication System Data Terminal	Mobile Telemetry
<b>Air Quality</b>	Increase in air emissions from construction on existing paved areas and operation would not affect the region's current attainment status	Increase in air emissions from operation would not affect the region's current attainment status
<b>Biological Resources</b>	Loss of small amount of previously disturbed vegetation. Temporary, short-term startle effects from noise to terrestrial wildlife and birds. Short-term operational impacts to wildlife (non-listed only) from security lighting and noise from electrical generators required for the site. Any lighting associated with the Proposed Action would be properly shielded following U.S. Fish and Wildlife Service guidelines to minimize disorientation impacts to birds.	Mobile sensors necessary to support Ground-Based Midcourse Defense Extended Test Range activities would be located on existing disturbed areas with minimal effect to biological resources.
<b>Hazardous Materials and Hazardous Waste</b>	The construction and operation of the In-Flight Interceptor Communication System Data Terminal would use small quantities of hazardous materials, which would result in the generation of some hazardous and non-hazardous waste. All hazardous materials and waste would be handled and disposed of in accordance with applicable state and federal regulations.	No impact from short term operation of mobile sensors at existing paved or concrete areas.

**Table ES-4: Impacts and Mitigation Summary, Reagan Test Site**

Resource Category	Reagan Test Site		
	Ground-Based Interceptor	Target	Sea-Based Test X-Band Radar
<b>Air Quality</b>	Single and dual Ground-Based Interceptor launch activities would be similar to previously analyzed launch activities; therefore there would be no change to the region's current attainment status.	A minimal increase in air emissions from target construction is expected. Single and dual target launch activities would be similar to previously analyzed launch activities. Therefore, there would be no change in the region's current attainment status.	The Sea-Based Test X-Band Radar would not be considered a stationary source; therefore a U.S. Army Kwajalein Atoll Environmental Standards New Source Review would not be required and the increase in air emissions from the operation of the Sea-Based Test X-Band Radar would not affect the region's current attainment status.
<b>Air Space</b>	Not analyzed.	Not analyzed.	Potential impacts to airspace would be minimized by adhering to operational requirements. An Electromagnetic Radiation/Electromagnetic Interference survey and analysis and DD Form 1494 would be required as part of the spectrum certification and frequency allocation process. The Sea-Based Test X-Band Radar high energy radiation area would be configured to minimize potential impacts to aircraft and other potentially affected systems, and would be published on aeronautical charts. In addition, Sea-Based Test X-Band Radar information would be published in the Airport Facility section of the <i>FAA Airport Guide</i> , and local Notices to Airmen would be issued. Flight service personnel would brief pilots flying in the vicinity about the Sea-Based Test X-Band Radar high energy radiation area.

**Table ES-4: Impacts and Mitigation Summary, Reagan Test Site (Continued)**

Resource Category	Reagan Test Site		
	Ground-Based Interceptor	Target	Sea-Based Test X-Band Radar
<b>Biological Resources</b>	Temporary effects to vegetation from emissions, discoloration and foliage loss. Temporary, short-term startle effects from noise to wildlife and birds. Although a remote possibility, individual animals close to the water's surface could be hit by debris. Personnel would be instructed to avoid areas designated as avian or sea turtle nesting or avian roosting habitat and to avoid all contact with any nest that may be encountered.	Temporary effects to vegetation from emissions, discoloration and foliage loss. Temporary, short-term startle effects from noise to wildlife and birds. Although a remote possibility, individual animals close to the water's surface could be hit by debris. Personnel would be instructed to avoid areas designated as avian or sea turtle nesting or avian roosting habitat and to avoid all contact with any nest that may be encountered.	Minor, short-term impacts from construction noise, such as startling and temporary displacement. The Sea-Based Test X-Band Radar is not expected to radiate lower than 2 degrees above horizontal and the relatively small radar beam would normally be in motion which reduces the probability of bird species, marine mammals, or sea turtles remaining within this limited region of space. The Sea-Based Test X-Band Radar vessel would incorporate marine pollution control devices such as keeping decks clear of debris, cleaning spills and residues, and engaging in spill and pollution prevention practices in compliance with the Uniform National Discharge Standards provisions of the Clean Water Act. The potential for impacts to marine mammals or sea turtles due to an accidental release of diesel fuel is considered low. The relatively slow speed of the Sea-Based Test X-Band Radar platform would preclude the potential for collision with a free-swimming marine mammal. Overall, no adverse impacts to marine mammals or sea turtles are anticipated.
<b>Hazardous Materials and Hazardous Waste</b>	Procedures for handling hazardous materials and hazardous waste related to Ground-Based Interceptor launches are currently utilized at Reagan Test Site. Measures would be employed in accordance with the U.S. Army Kwajalein Atoll Environmental Standards.	Procedures for handling hazardous materials and hazardous waste related to missile launches are already utilized at Reagan Test Site. Measures would be employed in accordance with the U.S. Army Kwajalein Atoll Environmental Standards.	Construction activities would result in generation of added wastes that would be accommodated in accordance with existing protocol and regulations. The Sea-Based Test X-Band Radar would follow U.S. Navy requirements that, to the maximum extent practicable, ships shall retain hazardous waste aboard ship for shore disposal. Handling and disposal of hazardous materials and hazardous waste would be in accordance with the U.S. Army Kwajalein Atoll Environmental Standards.

**Table ES-4: Impacts and Mitigation Summary, Reagan Test Site (Continued)**

Resource Category	Reagan Test Site		
	Ground-Based Interceptor	Target	Sea-Based Test X-Band Radar
<b>Health and Safety</b>	Health and safety procedures for the launch of Ground-Based Interceptors are currently in place at Reagan Test Site. Adherence to these procedures would result in no impacts to health and safety.	Health and safety procedures for the launch of target type missiles are currently in place at Reagan Test Site. Adherence to these procedures would result in no impacts to health and safety.	An Electromagnetic Radiation/Electromagnetic Interference survey and analysis and DD Form 1494 would be required as part of the spectrum certification and frequency allocation process. Implementation of Reagan Test Site operational safety procedures, including establishment of controlled areas, and limitations in the areas subject to illumination by the radar units, would preclude any potential safety hazard to either the public or workforce. These limitations would be similar to the existing Ground-Based Radar Prototype on Kwajalein, resulting in no impacts to health and safety.
<b>Utilities</b>	Not analyzed.	Not analyzed.	No impact.

**Table ES-5: Impacts and Mitigation Summary, Pacific Missile Range Facility**

Resource Category	Pacific Missile Range Facility
	TPS-X
<b>Air Quality</b>	It is anticipated that operation of the TPS-X would have no adverse impacts on regional air quality at PMRF. Therefore, there would be no change to the region's current attainment status.
<b>Biological Resources</b>	The TPS-X Radar is not expected to radiate lower than 5 degrees above horizontal and the relatively small radar beam would normally be in motion which reduces the probability of bird species remaining within this limited region of space.
<b>Hazardous Materials and Hazardous Waste</b>	TPS-X Radar activities would generate small quantities of hazardous waste. The use and disposal of hazardous materials and wastes would be in accordance with Pacific Missile Range Facility, State of Hawaii, Environmental Protection Agency, Occupational Safety and Health Administration, Department of Transportation, and Department of Defense policies and procedures.
<b>Health and Safety</b>	TPS-X Radar Electromagnetic Radiation hazard zones would be established within the beam's tracking space and near emitter equipment. A visual survey of the area would verify that all personnel are outside the hazard zone prior to startup. The TPS-X Radar would be prevented from illuminating in a designated cutoff zone, in which operators and all other system elements would be located. Potential interference with other electronic and emitter units (flight navigation systems, tracking radars, etc.) would also be examined prior to startup. Compliance with federal, state, and local health and safety requirements and regulations, safety procedures relative to radar operations, as well as Department of Defense and Pacific Missile Range Facility Safety Policy would result in no impacts to health and safety.
<b>Socioeconomics</b>	Though limited in scope, use of the TPS-X Radar, would have a minor positive effect on the local economy of the island.

**Table ES-6: Impacts and Mitigation Summary, Vandenberg Air Force Base**

Resource Category	Vandenberg Air Force Base		
	Ground-Based Interceptor	Target	In-Flight Interceptor Communication System Data Terminal
<b>Air Quality</b>	<p>The results of modeling to determine exhaust emissions of aluminum oxide, hydrogen chloride, and carbon monoxide show that concentrations produced by dual launches of a Ground-Based Interceptor would remain within National Ambient Air Quality Standards (NAAQS), California Ambient Air Quality Standards (AAQS), and U.S. Air Force standards. The review of the proposed action as required by the General Conformity Rule resulted in a finding of presumed conformity to the State Implementation Plan. Total foreseeable direct and indirect emissions caused by the proposed action would be both less than the mandated <i>de minimis</i> thresholds and less than 10 percent of the established Santa Barbara county Air Pollution Control District (SBCAPCD) budget. The Determination of Non-Applicability is included as appendix J of the EIS.</p> <p>Based upon this, the proposed launches would not cause or contribute to violation of any air quality standards.</p>	<p>The results of modeling a dual Peacekeeper target launch to determine exhaust emissions of aluminum oxide, hydrogen chloride, and carbon monoxide show that the level of hydrogen chloride would be below the 1-hour Air Force standard, but would exceed the peak hydrogen chloride standard for a short duration. Other emissions were determined to be within NAAQS and Alaska AAQS. A single Peacekeeper target launch would be within NAAQS, California AAQS, and U.S. Air Force standards. The review of the proposed action as required by the General Conformity Rule resulted in a finding of presumed conformity to the State Implementation Plan. Total foreseeable direct and indirect emissions caused by the proposed action would be both less than the mandated <i>de minimis</i> thresholds and less than 10 percent of the established SBCAPCD budget. The Determination of Non-Applicability is included as appendix J of the EIS.</p> <p>Based upon this, the proposed launches would not cause or contribute to violation of any air quality standards.</p>	<p>Minimal increase in air emissions from construction and operational activities would not affect the region's current attainment status.</p>
<b>Biological Resources</b>	<p>Temporary effects to vegetation from emissions, discoloration and foliage loss. Temporary, short-term startle effects from noise to wildlife and birds. Although a remote possibility, individual animals close to the water's surface could be hit by debris.</p>	<p>Temporary effects to vegetation from emissions, discoloration and foliage loss. Temporary, short-term startle effects from noise to wildlife and birds. Although a remote possibility, individual animals close to the water's surface could be hit by debris.</p>	<p>Loss of small amount of previously disturbed vegetation. Temporary, short-term startle effects from noise to terrestrial wildlife and birds. Short-term operational impacts to wildlife (non-listed only) from security lighting and noise from electrical generators required for the site.</p>
<b>Cultural Resources</b>	<p>Possible minor modifications may be required for buildings 1819 and 1900, as well as LF-02, LF-03, and LF-10. All of these are listed as National Register of Historic Places-eligible. Prior to the reuse of these facilities, consultation would occur with the State Historic Preservation Officer to ensure their protection or appropriate mitigation to preserve information concerning these buildings.</p> <p>Only in the unlikely event of flight termination over land (necessitating debris recovery within the region of influence) would the possibility for impacts to cultural resources from off-road vehicle activity exist. Even then, all areas affected by ground impacts of flight hardware would be cleared of all recoverable debris in strict accordance with current Vandenberg Air Force Base policy.</p>	<p>Possible minor modifications may be required for both LF-6 and LF-3. Both of these are listed as National Register of Historic Places-eligible. Prior to the reuse of these facilities, consultation would occur with the State Historic Preservation Officer to ensure their protection or appropriate mitigation to preserve information concerning the sites.</p> <p>Only in the unlikely event of flight termination over land (necessitating debris recovery within the region of influence) would the possibility for impacts to cultural resources from off-road vehicle activity exist. Even then, all areas affected by ground impacts of flight hardware would be cleared of all recoverable debris in strict accordance with current Vandenberg Air Force Base policy.</p>	<p>Effects could result from construction and modification. Once specific project details are delineated coordination would occur with the Environmental Planning Section and the Cultural Resources Section at Vandenberg Air Force Base to further ensure that cultural resources would be protected.</p>

**Table ES-6: Impacts and Mitigation Summary, Vandenberg Air Force Base (Continued)**

Resource Category	Vandenberg Air Force Base		
	Ground-Based Interceptor	Target	In-Flight Interceptor Communication System Data Terminal
<b>Geology and Soils</b>	Ground-Based Interceptor missile launches could cause minor alteration of local soil chemistry as a result of exhaust emissions, but would not result in adverse effects to soils.	Target missile launches could cause minor alteration of local soil chemistry as a result of exhaust emissions, but would not result in adverse effects to soils.	Minor effects to soils would be likely to occur as a result of potential soil erosion, depending on the local relief and soils at the selected alternate site.  Before determining the final site layout and design standards for the In-Flight Interceptor Communication System Data Terminal facilities, information bearing on seismic design and construction standards and surface faulting potential would be considered by the design engineer and geotechnical consultant.
<b>Hazardous Materials and Hazardous Waste</b>	Continued handling and use of limited quantities of hazardous and toxic materials related to Ground-Based Interceptor pre-launch, launch and post-launch activities would generate small quantities of hazardous waste. The use and disposal of hazardous materials and wastes would be in accordance with Vandenberg Air Force Base, State of California, Environmental Protection Agency, Occupational Safety and Health Administration, Department of Transportation, and Department of Defense policies and procedures.	Continued handling and use of limited quantities of hazardous and toxic materials related to target missile pre-launch, launch and post-launch activities would generate small quantities of hazardous waste. The use and disposal of hazardous materials and wastes would be in accordance with Vandenberg Air Force Base, State of California, Environmental Protection Agency, Occupational Safety and Health Administration, Department of Transportation, and Department of Defense policies and procedures.	Procedures for handling hazardous materials and hazardous waste from construction and operation of facilities similar to the In-Flight Interceptor Communication System Data Terminal are already utilized at Vandenberg Air Force Base. Quantities would be within existing use and disposal requirements.
<b>Health and Safety</b>	Planning and execution of Ground-Based Interceptor launches would continue. Ground and Launch Hazard Areas, Notices to Airmen and Notices to Mariners, and implementation of Safety plans would protect workers and the general public. Compliance with federal, state, local and Vandenberg Air Force Base health and safety requirements ensure there is no increase in risk to workers and the general public.	Planning and execution of target launches would continue. Ground and Launch Hazard Areas, Notices to Airmen and Notices to Mariners, and implementation of Safety plans would protect workers and the general public. Compliance with federal, state, local and Vandenberg Air Force Base health and safety requirements ensure there is no increase in risk to workers and the general public.	The In-Flight Interceptor Communication System Data Terminal emissions are considered to be of sufficiently low power so that there would be no exposure hazard and no impact to health and safety.
<b>Land Use</b>	Disruption to land use would occur from routine closures of recreation areas near the region of influence during Ground-Based Interceptor launches. Such action would represent a minimal impact to land use.	Disruption to land use would occur from routine closures of recreation areas near the region of influence during target launches. Such action would represent a minimal impact to land use.	Site preparation and new construction would be routinely accomplished and occur within an area compliant with the overall general land use; therefore no impacts would occur.
<b>Noise</b>	Noise impacts due to Ground-Based Interceptor launch activities would be similar to those that currently occur at Vandenberg Air Force Base during current missile launch activities. As launches are infrequent, short-term events, ambient noise levels at Vandenberg Air Force Base and the surrounding area would not be substantially affected on an annual basis.	Noise impacts due to target launch activities would be similar to launch activities that currently occur at Vandenberg Air Force Base. As launches are infrequent, short-term events, ambient noise levels at Vandenberg Air Force Base and the surrounding area would not be substantially affected on an annual basis.	Intermittent and short-term noise due to construction would be anticipated. Operational noise would stem from use of backup generator for the In-Flight Interceptor Communication System Data Terminal. This would not increase the noise levels of the regional environment

**Table ES-6: Impacts and Mitigation Summary, Vandenberg Air Force Base (Continued)**

Resource Category	Vandenberg Air Force Base		
	Ground-Based Interceptor	Target	In-Flight Interceptor Communication System Data Terminal
<b>Socioeconomics</b>	Base operations would continue to provide economic benefits with no impacts expected to occur.	Base operations would continue to provide economic benefits with no impacts expected to occur.	The presence of the In-Flight Interceptor Communication System Data Terminal construction personnel represents both a potential increase in local service based employment opportunities and a small but positive temporary economic impact to the local community. Base operations would continue to provide economic benefits with no impacts expected to occur.
<b>Transportation</b>	No impact.	No impact.	Temporary traffic delays to as a result of movement of construction equipment and material would cause minimal and infrequent traffic delays.
<b>Water Resources</b>	The Ground-Based Interceptor would disperse exhaust emission products over a large area. Previous studies concluded that water quality impacts would be adverse but not significant.	The target would disperse exhaust emission products over a large area. Previous studies concluded that water quality impacts would be adverse but not significant.	Minor potential for short-term increase in erosion and turbidity of surface waters during construction. In-Flight Interceptor Communication System Data Terminal construction would require a Construction Activities Storm Water General Permit from the California State Water Resources Control Board, or its local Central Coast Regional Water Quality Control Board. A related Stormwater Pollution Prevention Plan would also need to be prepared before the commencement of any soil-disturbing activities. All appropriate water quality-related Best Management Practices would be followed during construction, and related water quality impacts would not be significant.



**Table ES-7: Impacts and Mitigation Summary, Pearl Harbor**

Resource Category	Pearl Harbor, Moored off of Barbers Point
	Sea-Based Test X-Band Radar Primary Support Base and Mooring
<b>Air Quality</b>	The Sea-Based Test X-Band Radar would not be considered a stationary source and would not require a Prevention of Significant Deterioration review or a Title V permit. Air emissions from the operation of the Sea-Based Test X-Band Radar would be in compliance with appropriate State Implementation Plans.
<b>Airspace</b>	Potential impacts to airspace would be minimized by adhering to operational requirements. An Electromagnetic Radiation/Electromagnetic Interference survey and analysis and DD Form 1494 would be required as part of the spectrum certification and frequency allocation process. The Sea-Based Test X-Band Radar high energy radiation area would be configured to minimize potential impacts to aircraft and other potentially affected systems, and would be published on aeronautical charts. In addition, Sea-Based Test X-Band Radar information would be published in the Airport Facility section of the <i>FAA Airport Guide</i> , and local Notices to Airmen would be issued. Flight service personnel would brief pilots flying in the vicinity about the Sea-Based Test X-Band Radar high energy radiation area.
<b>Biological Resources</b>	Minor, short-term impacts from construction noise, such as startling and temporary displacement. The Sea-Based Test X-Band Radar is not expected to radiate lower than 10 degrees above horizontal at the mooring site, and the relatively small radar beam would normally be in motion which reduces the probability of bird species, marine mammals, or sea turtles remaining within this limited region of space. The Sea-Based Test X-Band Radar vessel would incorporate marine pollution control devices such as keeping decks clear of debris, cleaning spills and residues, and engaging in spill and pollution prevention practices in compliance with the Uniform National Discharge Standards provisions of the Clean Water Act. The potential for impacts to marine mammals or sea turtles due to an accidental release of diesel fuel is considered low. The relatively slow speed of the Sea-Based Test X-Band Radar platform would preclude the potential for collision with a free-swimming marine mammal. Overall, no adverse impacts to marine mammals or sea turtles are anticipated.
<b>Hazardous Materials and Hazardous Waste</b>	The small quantities amount of potentially hazardous materials used during construction activities would result in generation of added wastes that would be accommodated in accordance with existing protocol and regulations. The Sea-Based Test X-Band Radar would follow U.S. Navy requirements that, to the maximum extent practicable, ships shall retain hazardous waste aboard ship for shore disposal. In compliance with Uniform National Discharge Standards, the Sea-Based Test X-Band Radar vessel would incorporate marine pollution control devices, such as keeping decks clear of debris, cleaning spills and residues and engaging in spill and pollution prevention practices, in design or routine operation. Handling and disposal of hazardous materials and hazardous waste would be in accordance with State of Hawaii, Environmental Protection Agency, Occupational Safety and Health Administration, Department of Transportation, and Department of Defense policies and procedures.
<b>Health and Safety</b>	An Electromagnetic Radiation/Electromagnetic Interference survey and analysis and DD Form 1494 would be required as part of the spectrum certification and frequency allocation process. Implementation of Sea-Based Test X-Band Radar operational safety procedures, including establishment of controlled areas, and limitations in the areas subject to illumination by the radar units, would preclude any potential safety hazard to either the public or workforce. These limitations would be similar to the existing Ground-Based Radar Prototype on Kwajalein, resulting in no impacts to health and safety.
<b>Utilities</b>	Electricity demand, potable water consumption, wastewater usage, and solid waste disposal would be handled by existing facilities.
<b>Visual and Aesthetic Resources</b>	Visual impacts would be minor as the Sea-Based Test X-Band Radar would be comparable to ships passing along the horizon. The Sea-Based Test X-Band Radar would be moored at an adequate distance away from the shore and would not obstruct panoramic views. Visual resources could also be affected by the Sea-Based Test X-Band Radar if it is in the line-of-sight from boats to the island. However, the Sea-Based Test X-Band Radar would only inhibit the view of the island temporarily, as the boat passes by.

**Table ES-8: Impacts and Mitigation Summary, Naval Base Ventura County Port Hueneme**

Resource Category	Naval Base Ventura County Port Hueneme, Moored at San Nicolas Island
	Sea-Based Test X-Band Radar Primary Support Base and Mooring
<b>Air Quality</b>	The Sea-Based Test X-Band Radar would not be considered a stationary source and would not require a Prevention of Significant Deterioration review or a Title V permit. Air emissions from the operation of the Sea-Based Test X-Band Radar would be in compliance with appropriate State Implementation Plans.
<b>Airspace</b>	Potential impacts to airspace would be minimized by adhering to operational requirements. An Electromagnetic Radiation/Electromagnetic Interference survey and analysis and DD Form 1494 would be required as part of the spectrum certification and frequency allocation process. The Sea-Based Test X-Band Radar high energy radiation area would be configured to minimize potential impacts to aircraft and other potentially affected systems, and would be published on aeronautical charts. In addition, Sea-Based Test X-Band Radar information would be published in the Airport Facility section of the <i>FAA Airport Guide</i> , and local Notices to Airmen would be issued. Flight service personnel would brief pilots flying in the vicinity about the Sea-Based Test X-Band Radar high energy radiation area.
<b>Biological Resources</b>	Minor, short-term impacts from construction noise, such as startling and temporary displacement. The Sea-Based Test X-Band Radar is not expected to radiate lower than 10degrees above horizontal at the mooring site, and the relatively small radar beam would normally be in motion which reduces the probability of bird species, marine mammals, or sea turtles remaining within this limited region of space. The Sea-Based Test X-Band Radar vessel would incorporate marine pollution control devices such as keeping decks clear of debris, cleaning spills and residues, and engaging in spill and pollution prevention practices in compliance with the Uniform National Discharge Standards provisions of the Clean Water Act. The potential for impacts to marine mammals or sea turtles due to an accidental release of diesel fuel is considered low. The relatively slow speed of the Sea-Based Test X-Band Radar platform would preclude the potential for collision with a free-swimming marine mammal. No significant long-term adverse impacts are anticipated to seabirds and shorebirds, Guadalupe fur seals, California sea lions, northern elephant and harbor seals, and sea otters or to widely distributed, open-water species such as gray and killer whales.
<b>Hazardous Materials and Hazardous Waste</b>	The small quantities amount of potentially hazardous materials used during construction activities would result in generation of added wastes that would be accommodated in accordance with existing protocol and regulations. The Sea-Based Test X-Band Radar would follow U.S. Navy requirements that, to the maximum extent practicable, ships shall retain hazardous waste aboard ship for shore disposal. In compliance with Uniform National Discharge Standards, the Sea-Based Test X-Band Radar vessel would incorporate marine pollution control devices, such as keeping decks clear of debris, cleaning spills and residues and engaging in spill and pollution prevention practices, in design or routine operation. Handling and disposal of hazardous materials and hazardous waste would be in accordance with State of California, Environmental Protection Agency, Occupational Safety and Health Administration, Department of Transportation, and Department of Defense policies and procedures.
<b>Health and Safety</b>	An Electromagnetic Radiation/Electromagnetic Interference survey and analysis and DD Form 1494 would be required as part of the spectrum certification and frequency allocation process. Implementation of Sea-Based Test X-Band Radar operational safety procedures, including establishment of controlled areas, and limitations in the areas subject to illumination by the radar units, would preclude any potential safety hazard to either the public or workforce. These limitations would be similar to the existing Ground-Based Radar Prototype on Kwajalein, resulting in no impacts to health and safety.
<b>Utilities</b>	Electricity demand, potable water consumption, wastewater usage, and solid waste disposal would be handled by existing facilities.

**Table ES-9: Impacts and Mitigation Summary, Naval Station Everett**

Resource Category	Naval Station Everett, Moored at Pier Alpha or Bravo
	Sea-Based Test X-Band Radar Primary Support Base and Mooring
<b>Air Quality</b>	The Sea-Based Test X-Band Radar would not be considered a stationary source and would not require a Prevention of Significant Deterioration review or a Title V permit. Air emissions from the operation of the Sea-Based Test X-Band Radar would be in compliance with appropriate State Implementation Plans. Dust suppression measures such as periodic watering of areas being graded, minimizing unnecessary traffic, reducing vehicle speeds near the work areas, and wet sweeping or otherwise removing soil and mud deposits from paved roadways and parking areas, would be used as required for support facility construction.
<b>Airspace</b>	Potential impacts to airspace would be minimized by adhering to operational requirements. An Electromagnetic Radiation/Electromagnetic Interference survey and analysis and DD Form 1494 would be required as part of the spectrum certification and frequency allocation process. The Sea-Based Test X-Band Radar high energy radiation area would be configured to minimize potential impacts to aircraft and other potentially affected systems, and would be published on aeronautical charts. In addition, Sea-Based Test X-Band Radar information would be published in the Airport Facility section of the <i>FAA Airport Guide</i> , and local Notices to Airmen would be issued. Flight service personnel would brief pilots flying in the vicinity about the Sea-Based Test X-Band Radar high energy radiation area.
<b>Biological Resources</b>	Minor, short-term impacts from construction noise, such as startling and temporary displacement. The Sea-Based Test X-Band Radar is not expected to radiate lower than 10 degrees above horizontal at the mooring site, and the relatively small radar beam would normally be in motion which reduces the probability of bird species, marine mammals, or sea turtles remaining within this limited region of space. The Sea-Based Test X-Band Radar vessel would incorporate marine pollution control devices such as keeping decks clear of debris, cleaning spills and residues, and engaging in spill and pollution prevention practices in compliance with the Uniform National Discharge Standards provisions of the Clean Water Act. The potential for impacts to marine mammals or sea turtles due to an accidental release of diesel fuel is considered low. The relatively slow speed of the Sea-Based Test X-Band Radar platform would preclude the potential for collision with a free-swimming marine mammal. No significant long-term adverse impacts are anticipated to seabirds, shorebirds (bald eagle), Chinook salmon, bull trout, or widely distributed, open-water species such as humpback, blue, fin, sei, and sperm whales; green, leatherback, and loggerhead sea turtles; and steller sea lions.
<b>Hazardous Materials and Hazardous Waste</b>	The small quantities amount of potentially hazardous materials used during construction activities would result in generation of added wastes that would be accommodated in accordance with existing protocol and regulations. The Sea-Based Test X-Band Radar would follow U.S. Navy requirements that, to the maximum extent practicable, ships shall retain hazardous waste aboard ship for shore disposal. In compliance with Uniform National Discharge Standards, the Sea-Based Test X-Band Radar vessel would incorporate marine pollution control devices, such as keeping decks clear of debris, cleaning spills and residues and engaging in spill and pollution prevention practices, in design or routine operation. Handling and disposal of hazardous materials and hazardous waste would be in accordance with State of Washington, Environmental Protection Agency, Occupational Safety and Health Administration, Department of Transportation, and Department of Defense policies and procedures.
<b>Health and Safety</b>	An Electromagnetic Radiation/Electromagnetic Interference survey and analysis and DD Form 1494 would be required as part of the spectrum certification and frequency allocation process. Implementation of Sea-Based Test X-Band Radar operational safety procedures, including establishment of controlled areas, and limitations in the areas subject to illumination by the radar units, would preclude any potential safety hazard to either the public or workforce. These limitations would be similar to the existing Ground-Based Radar Prototype on Kwajalein, resulting in no impacts to health and safety.

**Table ES-9: Impacts and Mitigation Summary, Naval Station Everett (Continued)**

Resource Category	Naval Station Everett, Moored at Pier Alpha or Bravo
	Sea-Based Test X-Band Radar Primary Support Base and Mooring
<b>Socioeconomics</b>	<p>Construction activities related to the related to the implementation of Alternative 1 would not cause any displacement of populations, residences, or businesses within the city of Everett and surrounding areas. The additional construction personnel and the 50 on-board personnel associated with the proposed action would represent both a potential increase in local service-based employment opportunities and a small, but positive economic impact to the local economy. Visual impacts to the surrounding area would be partially mitigated by the fact that the Sea-Based Test X-Band Radar would be an additional structure on an existing military base immediately surrounded by industrial land uses thereby reducing the potential impacts to property values. Particularly in a port area where the mooring of ships and other Navy activities are a normal incidence of the military presence, a reduction of property values from the visual effect of large vessels in the harbor does not seem likely.</p> <p>Based on safety standards and documented analysis, the proposed operation of the Sea-Based Test X-Band Radar in port, with appropriate controls and coordination, will not pose a hazard to personnel or equipment. It is however worth noting that the perception by many persons that project related use of electromagnetic radiation does indeed pose a health risk could potentially lead to a diminished level of desirability, and therefore demand, for certain properties within the areas perceived to be affected; thereby having the potential to adversely affect property values within those areas. Given that this impact would be solely attributable to individual interpretation of a perceived risk, the extent and nature of the potential fall in property values, if any, and the areas affected are unable to be determined.</p>
<b>Transportation</b>	Adequate coordination would prevent any conflicts with tribal fishing areas, and would prevent any impacts on current shipping schedules, ship-borne commerce or general transit.
<b>Utilities</b>	Electricity demand, potable water consumption, wastewater usage, and solid waste disposal would be handled by existing facilities.
<b>Visual and Aesthetic Resources</b>	While there is a high amount of viewer concern, the Sea-Based Test X-Band Radar would be considered visually compatible with the port and present military uses; therefore, only moderate impacts are expected to visual resources.

**Table ES-10: Impacts and Mitigation Summary, Port Adak**

Resource Category	Port Adak, Moored at Finger Bay
	Sea-Based Test X-Band Radar Primary Support Base and Mooring
<b>Air Quality</b>	The Sea-Based Test X-Band Radar would not be considered a stationary source and would not require a Prevention of Significant Deterioration review or a Title V permit. Air emissions from the operation of the Sea-Based Test X-Band Radar would be in compliance with appropriate State Implementation Plans.
<b>Airspace</b>	Potential impacts to airspace would be minimized by adhering to operational requirements. An Electromagnetic Radiation/Electromagnetic Interference survey and analysis and DD Form 1494 would be required as part of the spectrum certification and frequency allocation process. The Sea-Based Test X-Band Radar high energy radiation area would be configured to minimize potential impacts to aircraft and other potentially affected systems, and would be published on aeronautical charts. In addition, Sea-Based Test X-Band Radar information would be published in the Airport Facility section of the <i>FAA Airport Guide</i> , and local Notices to Airmen would be issued. Flight service personnel would brief pilots flying in the vicinity about the Sea-Based Test X-Band Radar high energy radiation area.
<b>Biological Resources</b>	Minor, short-term impacts from construction noise, such as startling and temporary displacement. The Sea-Based Test X-Band Radar is not expected to radiate lower than 10 degrees above horizontal at the mooring site, and the relatively small radar beam would normally be in motion which reduces the probability of bird species, marine mammals, or sea turtles remaining within this limited region of space. The Sea-Based Test X-Band Radar vessel would incorporate marine pollution control devices such as keeping decks clear of debris, cleaning spills and residues, and engaging in spill and pollution prevention practices in compliance with the Uniform National Discharge Standards provisions of the Clean Water Act. The potential for impacts to marine mammals or sea turtles due to an accidental release of diesel fuel is considered low. The relatively slow speed of the Sea-Based Test X-Band Radar platform would preclude the potential for collision with a free-swimming marine mammal. No significant long-term adverse impacts are anticipated to area seabirds and water fowl or widely distributed, open-water species such as Steller sea lions, sea otters, harbor seals, and whales that occur around Adak Island.
<b>Hazardous Materials and Hazardous Waste</b>	The small quantities amount of potentially hazardous materials used during construction activities would result in generation of added wastes that would be accommodated in accordance with existing protocol and regulations. The Sea-Based Test X-Band Radar would follow U.S. Navy requirements that, to the maximum extent practicable, ships shall retain hazardous waste aboard ship for shore disposal. In compliance with Uniform National Discharge Standards, the Sea-Based Test X-Band Radar vessel would incorporate marine pollution control devices, such as keeping decks clear of debris, cleaning spills and residues and engaging in spill and pollution prevention practices, in design or routine operation. Handling and disposal of hazardous materials and hazardous waste would be in accordance with State of Alaska, Environmental Protection Agency, Occupational Safety and Health Administration, Department of Transportation, and Department of Defense policies and procedures.
<b>Health and Safety</b>	An Electromagnetic Radiation/Electromagnetic Interference survey and analysis and DD Form 1494 would be required as part of the spectrum certification and frequency allocation process. Implementation of Sea-Based Test X-Band Radar operational safety procedures, including establishment of controlled areas, and limitations in the areas subject to illumination by the radar units, would preclude any potential safety hazard to either the public or workforce. These limitations would be similar to the existing Ground-Based Radar Prototype on Kwajalein, resulting in no impacts to health and safety.
<b>Utilities</b>	Electricity demand, potable water consumption, wastewater usage, and solid waste disposal would be handled by existing facilities.
<b>Visual and Aesthetic Resources</b>	Due to limited visibility, a moderate scenic value and low viewer concern, there would be minimal adverse impacts to the visual resources at Adak.

**Table ES-11: Impacts and Mitigation Summary, Port of Valdez**

Resource Category	Port of Valdez, Moored in Pipeline Terminal Security Zone or at the Container Dock
	Sea-Based Test X-Band Radar Primary Support Base and Mooring
<b>Air Quality</b>	The Sea-Based Test X-Band Radar would not be considered a stationary source and would not require a Prevention of Significant Deterioration review or a Title V permit. Air emissions from the operation of the Sea-Based Test X-Band Radar would be in compliance with appropriate State Implementation Plans.
<b>Airspace</b>	Potential impacts to airspace would be minimized by adhering to operational requirements. An Electromagnetic Radiation/Electromagnetic Interference survey and analysis and DD Form 1494 would be required as part of the spectrum certification and frequency allocation process. The Sea-Based Test X-Band Radar high energy radiation area would be configured to minimize potential impacts to aircraft and other potentially affected systems, and would be published on aeronautical charts. In addition, Sea-Based Test X-Band Radar information would be published in the Airport Facility section of the <i>FAA Airport Guide</i> , and local Notices to Airmen would be issued. Flight service personnel would brief pilots flying in the vicinity about the Sea-Based Test X-Band Radar high energy radiation area.
<b>Biological Resources</b>	Minor, short-term impacts from construction noise, such as startling and temporary displacement. The Sea-Based Test X-Band Radar is not expected to radiate lower than 10 degrees above horizontal at the mooring site and the relatively small radar beam would normally be in motion which reduces the probability of bird species, marine mammals, or sea turtles remaining within this limited region of space. The Sea-Based Test X-Band Radar vessel would incorporate marine pollution control devices such as keeping decks clear of debris, cleaning spills and residues, and engaging in spill and pollution prevention practices in compliance with the Uniform National Discharge Standards provisions of the Clean Water Act. The potential for impacts to marine mammals or sea turtles due to an accidental release of diesel fuel is considered low. The relatively slow speed of the Sea-Based Test X-Band Radar platform would preclude the potential for collision with a free-swimming marine mammal. No significant long-term adverse impacts are anticipated to Essential Fish Habitat, area seabirds and water fowl, or widely distributed, open-water species such as humpback, killer, and minke whales, sea otters, Steller sea lions, harbor seals, and Dall and harbor porpoise that occur in Prince William Sound.
<b>Hazardous Materials and Hazardous Waste</b>	The small quantities amount of potentially hazardous materials used during construction activities would result in generation of added wastes that would be accommodated in accordance with existing protocol and regulations. The Sea-Based Test X-Band Radar would follow U.S. Navy requirements that, to the maximum extent practicable, ships shall retain hazardous waste aboard ship for shore disposal. In compliance with Uniform National Discharge Standards, the Sea-Based Test X-Band Radar vessel would incorporate marine pollution control devices, such as keeping decks clear of debris, cleaning spills and residues and engaging in spill and pollution prevention practices, in design or routine operation. Handling and disposal of hazardous materials and hazardous waste would be in accordance with State of Alaska, Environmental Protection Agency, Occupational Safety and Health Administration, Department of Transportation, and Department of Defense policies and procedures.
<b>Health and Safety</b>	An Electromagnetic Radiation/Electromagnetic Interference survey and analysis and DD Form 1494 would be required as part of the spectrum certification and frequency allocation process. Implementation of Sea-Based Test X-Band Radar operational safety procedures, including establishment of controlled areas, and limitations in the areas subject to illumination by the radar units, would preclude any potential safety hazard to either the public or workforce. These limitations would be similar to the existing Ground-Based Radar Prototype on Kwajalein, resulting in no impacts to health and safety.
<b>Transportation</b>	Coordination with local Native American groups would be necessary to prevent any impacts to native fishing areas, particularly during the August salmon run and during other peak fishing seasons. Coordination would be required with the U.S. Coast Guard to lessen requirements for channel (Valdez Narrows) closure and preclude potential delays of oil tankers utilizing the area, as well as to establish any required security zone at the mooring site.
<b>Utilities</b>	Electricity demand, potable water consumption, wastewater usage, and solid waste disposal would be handled by existing facilities.
<b>Visual and Aesthetic Resources</b>	Because Valdez is the site of the terminus of the Trans-Alaska Pipeline, numerous oil tankers are consistently entering Prince William Sound which would limit the impacts to visual resources caused by the Sea-Based Test X-Band Radar. However, adverse impacts to visual resources could occur due to some concerned viewers and a high scenic integrity rating for the location.

**Table ES-12: Impacts and Mitigation Summary, Broad Ocean Area**

Resource Category	Broad Ocean Area	
	Ground-Based Interceptor and Target Intercept Debris	Sea-Based Test X-Band Radar
<b>Airspace</b>	Where flight paths cross intercept debris areas, air traffic would be rerouted or rescheduled during a 3- to 4-hour period, approximately five times a year. Routing around the debris areas would be handled in a manner similar to severe weather. The additional time for commercial aircraft to avoid the area would generally be less than 10 minutes at cruising altitudes and speeds.	Testing would occur in remote areas and result in minimal impacts to airspace. An Electromagnetic Radiation/Electromagnetic Interference survey and analysis and DD Form 1494 would be required as part of the spectrum certification and frequency allocation process.
<b>Biological Resources</b>	No adverse impact.	No adverse impact. Power densities emitted by the Sea-Based Test X-Band Radar are unlikely to cause biological impacts.
<b>Health and Safety</b>	Testing operations pose potential impacts that would be minimized through pre-flight planning and coordination with the Federal Aviation Administration and issuance of Notices to Airmen and Notices to Mariners.	Testing operations pose potential impacts that would be minimized through pre-flight planning and issuance of Notices to Airmen and Notices to Mariners.
<b>Transportation</b>	Prior warning of Ground-Based Midcourse Defense Extended Test Range activities would allow commercial shipping to follow alternative routes away from the test area.	Minor impact to commercial shipping routes in the Gulf of Mexico or Pacific Ocean during testing.

**THIS PAGE INTENTIONALLY LEFT BLANK**



---

## **ACRONYMS AND ABBREVIATIONS**

---

# ACRONYMS AND ABBREVIATIONS

---

30 CES/CEX	Readiness Flight
30 SW	30 <sup>th</sup> Space Wing
30 SW/SE	Space Wing/Safety Office
AAC	Alaska Administrative Code
AADC	Alaska Aerospace Development Corporation
AAQS	Ambient Air Quality Standards
ADT	Average Daily Traffic
AFB	Air Force Base
AFI	Air Force Instruction
ait	Atmospheric Interceptor Technology
ALTRV	Altitude Reservation
AMHS	Alaska Marine Highway System
APSC	Alyeska Pipeline Service Company
ARTCC	Air Route Traffic Control Center
AST	Aboveground Storage Tank
BMDS	Ballistic Missile Defense System
BOA	Broad Ocean Area
°C	Degrees Celsius
CAE	Control Area Extension
CEQ	Council on Environmental Quality
CFR	Code of Federal Regulations
CHRIMP	Consolidated Hazardous Materials Reutilization and Inventory Management Program
CLEAN	Comprehensive Long-Term Environmental Action Navy
CNEL	Community Noise Equivalent Level
COMSATCOM	Commercial Satellite Communications
CTA/FIR	Control Area Flight Information Region
CVN	Aircraft Carrier, Nuclear
CZM	Coastal Zone Management
dB	Decibel(s)
dBA	A-weighted Decibel
DoD	Department of Defense
DOT	Department of Transportation
DRMO	Defense Reutilization and Marketing Office
EA	Environmental Assessment
EED	Electroexplosive Device
EIS	Environmental Impact Statement
EKV	Exoatmospheric Kill Vehicle
EMI	Electromagnetic Interference

EMR	Electromagnetic Radiation
EPA	Environmental Protection Agency
ESQD	Explosive Safety Quantity Distance
ETR	Extended Test Range
EWR	Eastern and Western Range
EWTA	Eglin Water Test Area
°F	Degrees Fahrenheit
FAA	Federal Aviation Administration
FCA	Flight Caution Area
FHA	Flight Hazard Area
FL	Flight Level
GBI	Ground-Based Interceptor
GBMC2	Ground-Based Battle Management Command and Control
GBMC3	Ground-Based Battle Management Command, Control, and Communications
GBR	Ground-Based Radar
GBR-P	Ground-Based Radar Prototype
GFC	Ground-Based Midcourse Defense Fire Control
GFC/C	Ground-Based Midcourse Defense Fire Control/Communications
GHz	Gigahertz
GMD	Ground-Based Midcourse Defense
HAZCORE	Hazardous Materials Consolidation and Redistribution
HERF	Hazards of Electromagnetic Radiation to Fuels
HERO	Hazards of Electromagnetic Radiation to Ordnance
HERP	Hazards of Electromagnetic Radiation to Personnel
HOST	Hawaii Operational Safety Team
HQ AFSPC/SG	Headquarters Air Force Space Command Surgeon General
Hz	Hertz
ICAO	International Civil Aviation Organization
IDLH	Immediately Dangerous to Life and Health
IDT	In-Flight Interceptor Communication System Data Terminal
IEEE	Institute of Electrical and Electronics Engineers
IFICS	In-Flight Interceptor Communication System
IFR	Instrument Flight Rules
ILMA	Interagency Land Management Agreement
IMO	International Maritime Organization
IRP	Installation Restoration Program
ISO	International Organization for Standards
JP	Jet Petroleum
KLC	Kodiak Launch Complex
KTF	Kauai Test Facility

kV	Kilovolt
kVA	Kilovolt Amperes
kW	Kilowatt
LATRA	Launch Area Toxic Risk Analysis
L <sub>dn</sub>	Day-night Average Sound Level
L <sub>eq</sub>	Equivalent Sound Level
L <sub>max</sub>	Maximum Sound Level
LF	Launch Facility
LSS	Launch Service Structure
MDA	Missile Defense Agency
μg/m <sup>3</sup>	Micrograms Per Cubic Meter
mg/m <sup>3</sup>	Milligram Per Cubic Meter
MHz	Megahertz
MILSATCOM	Military Satellite Communications System
MLP	Mobile Launch Platform
M <sub>max</sub>	Maximum Magnitude
MOGAS	Motor Vehicle Gasoline
MPEL	Maximum Permissible Exposure Limit
MSDS	Material Safety Data Sheet
MSO	Marine Safety Office
Mw	Moment Magnitude
MW	Megawatt
mW/cm <sup>2</sup>	Milliwatts per Square Centimeter
NAAQS	National Ambient Air Quality Standards
NAS	Naval Air Station
National Register	<i>National Register of Historic Places</i>
NAVSEAOP	Naval Sea System Command
NAWCWD	Naval Air Warfare Center, Weapons Division
NBVC	Naval Base Ventura County
NEPA	National Environmental Policy Act
NIOSH	National Institute for Occupational Safety and Health
NMD	National Missile Defense
NOA	Notice of Availability
NOTAM	Notice to Airmen
NOTMAR	Notice to Mariners
NPRM	Notice of Proposed Rulemaking
NRMP	Natural Resources Management Plan
OBODM	Open Burn/Open Detonation Dispersion Model
OCC	Operations Control Center
OSHA	Occupational Safety and Health Administration
PCB	Polychlorinated Biphenyl

PEL	Permissible Exposure Level
PL	Public Law
PM-10	Particulate Matter with an Aerodynamic Diameter of Less Than or Equal to 10 Micrometers
PMRF	Pacific Missile Range Facility
PMRFINST	Pacific Missile Range Facility Instruction
POL	Petroleum, Oil, and Lubricant
ppm	Parts Per Million
PPMP	Pollution Prevention Management Plan
PSB	Primary Support Base
QRLV	Quick Reaction Launch Vehicle
RCC	Range Commanders Council
RCRA	Resource Conservation and Recovery Act
RF	Radiofrequency
RMI	Republic of the Marshall Islands
ROD	Record of Decision
ROI	Region of Influence
RSS	Radar Support Structure
RTS	Ronald Reagan Ballistic Missile Defense Test Site
SBCAPCD	Santa Barbara County Air Pollution Control District
SBX	Sea-Based Test X-Band Radar
SOP	Standard Operating Procedure
SPCC	Spill Prevention Control and Countermeasures
SR	State Route
TAPS	Trans-Alaska Pipeline System
THAAD	Theater High Altitude Area Defense
TLV	Target Launch Vehicle
TPS-X	Transportable System Radar
TTS	Temporary Threshold Shift
UAF	University of Alaska, Fairbanks
UES	USAKA Environmental Standards
UNDS	Uniform National Discharge Standards
USAKA	United States Army Kwajalein Atoll
USC	United States Code
USFWS	United States Fish and Wildlife Service
UST	Underground Storage Tank
VFR	Visual Flight Rules
V/m	Volts Per Meter
XBR	X-Band Radar

---

# CONTENTS

---

# CONTENTS

## VOLUME 1

	Page
EXECUTIVE SUMMARY .....	es-1
ACRONYMS AND ABBREVIATIONS.....	ac-1
1.0 PURPOSE OF AND NEED FOR THE PROPOSED ACTION .....	1-1
1.1 Introduction.....	1-1
1.2 Background .....	1-1
1.3 Purpose of the Proposed Action.....	1-3
1.4 Need for the Proposed Action .....	1-4
1.5 Scope of the Environmental Impact Statement .....	1-4
1.6 Decisions To Be Made .....	1-7
1.7 Cooperating Agencies .....	1-7
1.8 Summary of the Public Scoping Process .....	1-9
1.9 Summary of Draft Environmental Impact Statement Public Review Process...	1-13
1.10 Related Environmental Documentation .....	1-16
2.0 Description of Proposed Action and Alternatives .....	2-1
2.1 GMD Extended Test Range Components and Operations .....	2-3
2.1.1 Ground-Based Interceptor Systems .....	2-3
2.1.2 Target Missile Systems.....	2-5
2.1.3 In-Flight Interceptor Communication System Data Terminal Options...	2-13
2.1.4 Sea-Based Test X-Band Radar .....	2-17
2.1.5 Test Range Sensors and Support Instrumentation.....	2-29
2.1.6 Flight Test Planning and Operations .....	2-34
2.1.7 Flight Test Safety.....	2-39
2.1.8 Flight Test Example Scenarios .....	2-41
2.2 No Action Alternative .....	2-48
2.2.1 Launch Sites and Other Support Facilities .....	2-48
2.2.2 Mobile GMD System Elements.....	2-50
2.3 Proposed Action .....	2-50
2.3.1 Alternative 1 .....	2-51
2.3.2 Alternative 2.....	2-82
2.3.3 Alternative 3—Combination of Alternatives 1 and 2 .....	2-90
2.4 Alternatives Considered But Not Carried Forward .....	2-90
2.4.1 GBI Launch Location Alternatives .....	2-90
2.4.2 Target Launch Location Alternatives .....	2-91
2.4.3 IDT Location Alternatives.....	2-91
2.4.4 Sea-Based Test X-Band Radar Primary Support Base Alternatives ....	2-91
2.4.5 Mobile Telemetry and Mobile C-Band Radar Location Alternatives .....	2-92

3.0	AFFECTED ENVIRONMENT .....	3-1
3.1	Kodiak Launch Complex .....	3-2
3.1.1	Air Quality—Kodiak Launch Complex.....	3-2
3.1.2	Airspace—Kodiak Launch Complex .....	3-5
3.1.3	Biological Resources—Kodiak Launch Complex.....	3-7
3.1.4	Cultural Resources—Kodiak Launch Complex.....	3-12
3.1.5	Geology and Soils—Kodiak Launch Complex .....	3-14
3.1.6	Hazardous Materials and Hazardous Waste—Kodiak Launch Complex.....	3-19
3.1.7	Health and Safety—Kodiak Launch Complex.....	3-22
3.1.8	Land Use—Kodiak Launch Complex.....	3-25
3.1.9	Noise—Kodiak Launch Complex .....	3-26
3.1.10	Socioeconomics—Kodiak Launch Complex.....	3-29
3.1.11	Transportation—Kodiak Launch Complex .....	3-32
3.1.12	Utilities—Kodiak Launch Complex.....	3-34
3.1.13	Visual and Aesthetic Resources—Kodiak Launch Complex .....	3-37
3.1.14	Water Resources—Kodiak Launch Complex .....	3-38
3.1.15	Subsistence—Kodiak Launch Complex.....	3-41
3.2	Midway .....	3-43
3.2.1	Air Quality—Midway .....	3-43
3.2.2	Biological Resources—Midway .....	3-45
3.2.3	Hazardous Materials and Hazardous Waste—Midway .....	3-46
3.3	Reagan Test Site.....	3-48
3.3.1	Air Quality—Reagan Test Site.....	3-49
3.3.2	Airspace—Reagan Test Site .....	3-53
3.3.3	Biological Resources—Reagan Test Site .....	3-56
3.3.4	Hazardous Materials and Hazardous Waste—Reagan Test Site.....	3-60
3.3.5	Health and Safety—Reagan Test Site.....	3-63
3.3.6	Utilities—Reagan Test Site.....	3-67
3.4	Pacific Missile Range Facility .....	3-70
3.4.1	Air Quality—Pacific Missile Range Facility .....	3-71
3.4.2	Biological Resources—Pacific Missile Range Facility .....	3-72
3.4.3	Hazardous Materials and Hazardous Waste—Pacific Missile Range Facility .....	3-78
3.4.4	Health and Safety—Pacific Missile Range Facility .....	3-81
3.4.5	Socioeconomics—Pacific Missile Range Facility.....	3-86
3.5	Vandenberg Air Force Base .....	3-89
3.5.1	Air Quality—Vandenberg Air Force Base .....	3-90
3.5.2	Biological Resources—Vandenberg Air Force Base .....	3-91
3.5.3	Cultural Resources—Vandenberg Air Force Base .....	3-97
3.5.4	Geology and Soils—Vandenberg Air Force Base.....	3-98
3.5.5	Hazardous Materials and Hazardous Waste—Vandenberg Air Force Base .....	3-101
3.5.6	Health and Safety—Vandenberg Air Force Base .....	3-103
3.5.7	Land Use—Vandenberg Air Force Base .....	3-110
3.5.8	Noise—Vandenberg Air Force Base.....	3-112
3.5.9	Socioeconomics—Vandenberg Air Force Base.....	3-114
3.5.10	Transportation—Vandenberg Air Force Base.....	3-116
3.5.11	Water Resources—Vandenberg Air Force Base .....	3-119
3.6	Pearl Harbor—Sea-Based Test X-Band Radar Primary Support Base.....	3-121



3.6.1	Air Quality—Sea-Based Test X-Band Radar Primary Support Base, Pearl Harbor .....	3-122
3.6.2	Airspace—Sea-Based Test X-Band Radar Primary Support Base, Pearl Harbor .....	3-123
3.6.3	Biological Resources—Sea-Based Test X-Band Radar Primary Support Base, Pearl Harbor.....	3-125
3.6.4	Hazardous Materials and Hazardous Waste—Sea-Based Test X-Band Radar Primary Support Base, Pearl Harbor .....	3-126
3.6.5	Health and Safety—Sea-Based Test X-Band Radar Primary Support Base, Pearl Harbor.....	3-128
3.6.6	Utilities—Sea-Based Test X-Band Radar Primary Support Base, Pearl Harbor .....	3-130
3.6.7	Visual and Aesthetic Resources—Sea-Based Test X-Band Radar Primary Support Base, Pearl Harbor .....	3-131
3.7	NBVC Port Hueneme—Sea-Based Test X-Band Radar Primary Support Base .....	3-132
3.7.1	Air Quality—Sea-Based Test X-Band Radar Primary Support Base, NBVC Port Hueneme .....	3-133
3.7.2	Airspace—Sea-Based Test X-Band Radar Primary Support Base, NBVC Port Hueneme.....	3-134
3.7.3	Biological Resources—Sea-Based Test X-Band Radar Primary Support Base, NBVC Port Hueneme .....	3-136
3.7.4	Hazardous Materials and Hazardous Waste—Sea-Based Test X-Band Radar Primary Support Base, NBVC Port Hueneme.....	3-137
3.7.5	Health and Safety—Sea-Based Test X-Band Radar Primary Support Base, NBVC Port Hueneme .....	3-138
3.7.6	Utilities—Sea-Based Test X-Band Radar Primary Support Base, NBVC Port Hueneme.....	3-139
3.8	Naval Station Everett—Sea-Based Test X-Band Radar Primary Support Base .....	3-141
3.8.1	Air Quality—Sea-Based Test X-Band Radar Primary Support Base, Naval Station Everett.....	3-141
3.8.2	Airspace—Sea-Based Test X-Band Radar Primary Support Base, Naval Station Everett.....	3-142
3.8.3	Biological Resources—Sea-Based Test X-Band Radar Primary Support Base, Naval Station Everett .....	3-143
3.8.4	Hazardous Materials and Hazardous Waste—Sea-Based Test X-Band Radar Primary Support Base, Naval Station Everett .....	3-145
3.8.5	Health and Safety—Sea-Based Test X-Band Radar Primary Support Base, Naval Station Everett .....	3-146
3.8.6	Socioeconomics—Sea-Based Test X-Band Radar Primary Support Base, Naval Station Everett .....	3-147
3.8.7	Transportation—Sea-Based Test X-Band Radar Primary Support Base, Naval Station Everett .....	3-149
3.8.8	Utilities—Sea-Based Test X-Band Radar Primary Support Base, Naval Station Everett.....	3-151
3.8.9	Visual and Aesthetic Resources—Sea-Based Test X-Band Radar Primary Support Base, Naval Station Everett .....	3-152
3.9	Port Adak—Sea-Based Test X-Band Radar Primary Support Base .....	3-153
3.9.1	Air Quality—Sea-Based Test X-Band Radar Primary Support Base, Port Adak.....	3-154

3.9.2	Airspace—Sea-Based Test X-Band Radar Primary Support Base, Port Adak.....	3-155
3.9.3	Biological Resources—Sea-Based Test X-Band Radar Primary Support Base, Port Adak.....	3-157
3.9.4	Hazardous Materials and Hazardous Waste—Sea-Based Test X-Band Radar Primary Support Base, Port Adak.....	3-157
3.9.5	Health and Safety—Sea-Based Test X-Band Radar Primary Support Base, Port Adak.....	3-158
3.9.6	Utilities—Sea-Based Test X-Band Radar Primary Support Base, Port Adak.....	3-159
3.9.7	Visual and Aesthetic Resources—Sea-Based Test X-Band Radar Primary Support Base, Port Adak.....	3-160
3.10	Port of Valdez—Sea-Based Test X-Band Radar Primary Support Base.....	3-161
3.10.1	Air Quality—Sea-Based Test X-Band Radar Primary Support Base, Port of Valdez.....	3-162
3.10.2	Airspace—Sea-Based Test X-Band Radar Primary Support Base, Port of Valdez.....	3-163
3.10.3	Biological Resources—Sea-Based Test X-Band Radar Primary Support Base, Port of Valdez.....	3-165
3.10.4	Hazardous Materials and Hazardous Waste—Sea-Based Test X-Band Radar Primary Support Base, Port of Valdez.....	3-166
3.10.5	Health and Safety—Sea-Based Test X-Band Radar Primary Support Base, Port of Valdez.....	3-168
3.10.6	Transportation—Sea-Based Test X-Band Radar Primary Support Base, Port of Valdez.....	3-169
3.10.7	Utilities—Sea-Based Test X-Band Radar Primary Support Base, Port of Valdez.....	3-170
3.10.8	Visual and Aesthetic Resources—Sea-Based Test X-Band Radar Primary Support Base, Port of Valdez.....	3-172
3.11	Broad Ocean Area (Executive Order 12114).....	3-173
3.11.1	Airspace—Broad Ocean Area.....	3-174
3.11.2	Biological Resources—Broad Ocean Area.....	3-183
3.11.3	Health and Safety—Broad Ocean Area.....	3-188
3.11.4	Transportation—Broad Ocean Area.....	3-192
3.12	Environmental Justice.....	3-198
4.0	ENVIRONMENTAL CONSEQUENCES.....	4-1
4.1	Kodiak Launch Complex.....	4-2
4.1.1	Air Quality—Kodiak Launch Complex.....	4-2
4.1.2	Airspace—Kodiak Launch Complex.....	4-17
4.1.3	Biological Resources—Kodiak Launch Complex.....	4-19
4.1.4	Cultural Resources—Kodiak Launch Complex.....	4-35
4.1.5	Geology and Soils—Kodiak Launch Complex.....	4-41
4.1.6	Hazardous Materials and Hazardous Waste—Kodiak Launch Complex.....	4-48
4.1.7	Health and Safety—Kodiak Launch Complex.....	4-54
4.1.8	Land Use—Kodiak Launch Complex.....	4-67
4.1.9	Noise—Kodiak Launch Complex.....	4-75
4.1.10	Socioeconomics—Kodiak Launch Complex.....	4-83
4.1.11	Transportation—Kodiak Launch Complex.....	4-89
4.1.12	Utilities—Kodiak Launch Complex.....	4-98

4.1.13	Visual and Aesthetic Resources—Kodiak Launch Complex .....	4-106
4.1.14	Water Resources—Kodiak Launch Complex .....	4-109
4.1.15	Subsistence—Kodiak Launch Complex.....	4-116
4.2	Midway .....	4-118
4.2.1	Air Quality—Midway .....	4-118
4.2.2	Biological Resources—Midway .....	4-120
4.2.3	Hazardous Materials and Hazardous Waste—Midway .....	4-122
4.3	Reagan Test Site.....	4-124
4.3.1	Air Quality—Reagan Test Site.....	4-124
4.3.2	Airspace—Reagan Test Site .....	4-129
4.3.3	Biological Resources—Reagan Test Site.....	4-132
4.3.4	Hazardous Materials and Hazardous Waste—Reagan Test Site.....	4-139
4.3.5	Health and Safety—Reagan Test Site.....	4-143
4.3.6	Utilities—Reagan Test Site.....	4-150
4.4	Pacific Missile Range Facility .....	4-153
4.4.1	Air Quality—Pacific Missile Range Facility .....	4-153
4.4.2	Biological Resources—Pacific Missile Range Facility .....	4-156
4.4.3	Hazardous Materials and Hazardous Waste—Pacific Missile Range Facility .....	4-162
4.4.4	Health and Safety—Pacific Missile Range Facility .....	4-164
4.4.5	Socioeconomics—Pacific Missile Range Facility.....	4-168
4.5	Vandenberg Air Force Base .....	4-169
4.5.1	Air Quality—Vandenberg Air Force Base .....	4-169
4.5.2	Biological Resources—Vandenberg Air Force Base .....	4-179
4.5.3	Cultural Resources—Vandenberg Air Force Base .....	4-193
4.5.4	Geology and Soils—Vandenberg Air Force Base.....	4-197
4.5.5	Hazardous Materials and Hazardous Waste—Vandenberg Air Force Base .....	4-200
4.5.6	Health and Safety—Vandenberg Air Force Base .....	4-204
4.5.7	Land Use—Vandenberg Air Force Base .....	4-209
4.5.8	Noise—Vandenberg Air Force Base.....	4-212
4.5.9	Socioeconomics—Vandenberg Air Force Base.....	4-218
4.5.10	Transportation—Vandenberg Air Force Base.....	4-221
4.5.11	Water Resources—Vandenberg Air Force Base .....	4-224
4.6	Pearl Harbor—Sea-Based Test X-Band Radar Primary Support Base.....	4-227
4.6.1	Air Quality—Sea-Based Test X-Band Radar Primary Support Base, Pearl Harbor .....	4-227
4.6.2	Airspace—Sea-Based Test X-Band Radar Primary Support Base, Pearl Harbor .....	4-228
4.6.3	Biological Resources—Sea-Based Test X-Band Radar Primary Support Base, Pearl Harbor.....	4-231
4.6.4	Hazardous Materials and Hazardous Waste—Sea-Based Test X-Band Radar Primary Support Base, Pearl Harbor .....	4-232
4.6.5	Health and Safety—Sea-Based Test X-Band Radar Primary Support Base, Pearl Harbor.....	4-234
4.6.6	Utilities—Sea-Based Test X-Band Radar Primary Support Base, Pearl Harbor .....	4-235
4.6.7	Visual and Aesthetic Resources—Sea-Based Test X-Band Radar Primary Support Base, Pearl Harbor .....	4-237
4.7	NBVC Port Hueneme—Sea-Based Test X-Band Radar Primary Support Base .....	4-240

4.7.1	Air Quality—Sea-Based Test X-Band Radar Primary Support Base, NBVC Port Hueneme .....	4-240
4.7.2	Airspace—Sea-Based Test X-Band Radar Primary Support Base, Port Hueneme .....	4-241
4.7.3	Biological Resources—Sea-Based Test X-Band Radar Primary Support Base, Port Hueneme.....	4-243
4.7.4	Hazardous Materials and Hazardous Waste—Sea-Based Test X-Band Radar Primary Support Base, NBVC Port Hueneme.....	4-244
4.7.5	Health and Safety—Sea-Based Test X-Band Radar Primary Support Base, Port Hueneme.....	4-246
4.7.6	Utilities—Sea-Based Test X-Band Radar Primary Support Base, Port Hueneme.....	4-247
4.8	Naval Station Everett—Sea-Based Test X-Band Radar Primary Support Base .....	4-250
4.8.1	Air Quality—Sea-Based Test X-Band Radar Primary Support Base, Naval Station Everett.....	4-250
4.8.2	Airspace—Sea-Based Test X-Band Radar Primary Support Base, Naval Station Everett.....	4-251
4.8.3	Biological Resources—Sea-Based Test X-Band Radar Primary Support Base, Naval Station Everett .....	4-254
4.8.4	Hazardous Materials and Hazardous Waste—Sea-Based Test X-Band Radar Primary Support Base, Naval Station Everett.....	4-254
4.8.5	Health and Safety—Sea-Based Test X-Band Radar Primary Support Base, Naval Station Everett .....	4-256
4.8.6	Socioeconomics—Sea-Based Test X-Band Radar Primary Support Base, Naval Station Everett .....	4-257
4.8.7	Transportation—Sea-Based Test X-Band Radar Primary Support Base, Naval Station Everett .....	4-261
4.8.8	Utilities—Sea-Based Test X-Band Radar Primary Support Base, Naval Station Everett .....	4-262
4.8.9	Visual and Aesthetic Resources—Sea-Based Test X-Band Radar Primary Support Base, Naval Station Everett.....	4-264
4.9	Port Adak—Sea-Based Test X-Band Radar Primary Support Base .....	4-267
4.9.1	Air Quality—Sea-Based Test X-Band Radar Primary Support Base, Port Adak.....	4-267
4.9.2	Airspace—Sea-Based Test X-Band Radar Primary Support Base, Port Adak.....	4-268
4.9.3	Biological Resources—Sea-Based Test X-Band Radar Primary Support Base, Port Adak .....	4-270
4.9.4	Hazardous Materials and Hazardous Waste—Sea-Based Test X-Band Radar Primary Support Base, Port Adak .....	4-271
4.9.5	Health and Safety—Sea-Based Test X-Band Radar Primary Support Base, Port Adak .....	4-272
4.9.6	Utilities—Sea-Based Test X-Band Radar Primary Support Base, Port Adak.....	4-273
4.9.7	Visual and Aesthetic Resources—Sea-Based Test X-Band Radar Primary Support Base, Port Adak .....	4-275
4.10	Port of Valdez—Sea-Based Test X-Band Radar Primary Support Base.....	4-278
4.10.1	Air Quality—Sea-Based Test X-Band Radar Primary Support Base, Port of Valdez.....	4-278

4.10.2	Airspace—Sea-Based Test X-Band Radar Primary Support Base, Port of Valdez .....	4-279
4.10.3	Biological Resources—Sea-Based Test X-Band Radar Primary Support Base, Port of Valdez .....	4-282
4.10.4	Hazardous Materials and Hazardous Waste—Sea-Based Test X-Band Radar Primary Support Base, Port of Valdez .....	4-282
4.10.5	Health and Safety—Sea-Based Test X-Band Radar Primary Support Base, Port of Valdez .....	4-283
4.10.6	Transportation—Sea-Based Test X-Band Radar Primary Support Base, Port of Valdez .....	4-285
4.10.7	Utilities—Sea-Based Test X-Band Radar Primary Support Base, Port of Valdez .....	4-286
4.10.8	Visual and Aesthetic Resources—Sea-Based Test X-Band Radar Primary Support Base, Port of Valdez .....	4-288
4.11	Broad Ocean Area .....	4-291
4.11.1	Airspace—Broad Ocean Area .....	4-291
4.11.2	Biological Resources—Broad Ocean Area .....	4-297
4.11.3	Health and Safety—Broad Ocean Area .....	4-304
4.11.4	Transportation—Broad Ocean Area .....	4-306
4.12	Conflicts With Federal, State, and Local Land Use Plans, Policies, and Controls For the Area Concerned.....	4-307
4.13	Energy Requirements and Conservation Potential.....	4-307
4.14	Natural or Depletable Resource Requirements and Conservation Potential .....	4-308
4.15	Adverse Environmental Effects That Cannot Be Avoided .....	4-308
4.16	Relationship Between Short-Term Use of the Human Environment and the Maintenance and Enhancement of Long-Term Productivity.....	4-308
4.17	Irreversible or Irrecoverable Commitment of Resources .....	4-308
4.18	Federal Actions To Address Protection of Children from Environmental Health Risks and Safety Risks (Executive Order 13045, as Amended by Executive Order 13229) .....	4-309

## VOLUME 2

5.0	LIST OF PREPARERS	
6.0	GLOSSARY OF TERMS	
7.0	PUBLIC SCOPING COMMENTS.....	7-1
7.1	Air Quality .....	7-5
7.2	Airspace .....	7-5
7.3	Biological Resources .....	7-5
7.4	Cultural Resources .....	7-6
7.5	Environmental Impact Statement Process .....	7-6
7.6	Environmental Justice .....	7-9
7.7	Geology and Soils .....	7-9
7.8	Hazardous Materials and Hazardous Wastes Management .....	7-9
7.9	Health and Safety .....	7-11

7.10	Land Use and Aesthetics .....	7-13
7.11	Noise .....	7-14
7.12	Policy .....	7-14
7.13	Program .....	7-17
7.14	Socioeconomics .....	7-21
7.15	Subsistence .....	7-22
7.16	Transportation .....	7-22
7.17	Utilities .....	7-23
7.18	Water Resources .....	7-23
7.19	Other .....	7-24
8.0	DRAFT ENVIRONMENTAL IMPACT STATEMENT COMMENTS AND RESPONSES .....	8-1
8.1	GMD ETR Draft EIS Public Involvement Policy .....	8-1
8.1.1	Written Comment Documents—Draft EIS .....	8-7
8.1.2	Email Comment Documents—Draft EIS .....	8-175
8.1.3	Public Hearing Comment Documents—Draft EIS .....	8-377
8.1.4	Oral Comment Documents—Draft EIS .....	8-529

## **VOLUME 3**

9.0	CONSULTATION COMMENTS AND RESPONSES
10.0	REFERENCES
11.0	DISTRIBUTION LIST

## **APPENDICES**

A	RELATED ENVIRONMENTAL DOCUMENTATION
B	RESOURCE DESCRIPTIONS INCLUDING LAWS AND REGULATIONS CONSIDERED
C	MISSILE LAUNCH SAFETY AND EMERGENCY RESPONSE
D	ENGINEERING FIELD ANALYSIS OF SEISMIC DESIGN BUILDING STANDARDS FOR EXISTING FACILITIES AT KODIAK LAUNCH COMPLEX
E	POTENTIAL PERMITS, LICENSES, AND ENTITLEMENTS REQUIRED
F	COOPERATING AGENCIES ACCEPTANCE LETTERS
G	ELECTROMAGNETIC RADIATION SUMMARY
H	THREATENED AND ENDANGERED SPECIES DESCRIPTIONS
I	TYPICAL STANDARD OPERATING PROCEDURES AND BEST MANAGEMENT PRACTICES
J	DETERMINATION OF NON-APPLICABILITY GROUND-BASED MIDCOURSE DEFENSE EXTENDED TEST RANGE ENVIRONMENTAL IMPACT STATEMENT, VANDENBERG AIR FORCE BASE, CALIFORNIA

INDEX

## FIGURES

ES-1	GMD Element Architecture.....	es-3
ES-2	Potential GMD ETR Test and Test Support Locations, Pacific Ocean.....	es-5
1.2-1	Phases of Ballistic Missile Flight and the Concept for Ground-Based Midcourse Defense .....	1-2
1.5-1	Potential GMD ETR Test and Test Support Locations, Pacific Ocean.....	1-6
2.1.1-1	Conceptual Ground-Based Interceptor.....	2-3
2.1.2-1	Representative Launch Vehicles Comparison .....	2-7
2.1.2-2	Typical Aerial Target Extraction and Launch.....	2-10
2.1.2-3	Representative Mobile Sea Launch Vessel, Alternative Target Launch Mode .....	2-12
2.1.3-1	Conceptual Fixed and Mobile IDTs .....	2-14
2.1.3-2	Representative COMSATCOM Earth Terminal.....	2-16
2.1.4-1	Conceptual Sea-Based Test X-Band Radar.....	2-18
2.1.4-2	SBX Radar Potential Interference .....	2-20
2.1.4-3	SBX Performance Regions, Pacific Ocean .....	2-27
2.1.5-1	Representative Radar and Telemetry Equipment .....	2-30
2.1.5-2	Representative Range Safety and Telemetry Systems.....	2-30
2.1.5-3	TPS-X Radar Components.....	2-33
2.1.5-4	Representative Mobile Telemetry Equipment .....	2-33
2.1.5-5	Mobile Telemetry Location Alternatives, Pacific Ocean .....	2-35
2.1.6-1	Typical GMD Flight Test Clearance Areas .....	2-38
2.1.8-1	Scenario 1: Target Launched from Vandenberg Air Force Base, Intercepted from Reagan Test Site, Pacific Ocean .....	2-42
2.1.8-2	Scenario 2: Target Launched from Kodiak Launch Complex, Intercepted from Reagan Test Site, Pacific Ocean .....	2-43
2.1.8-3	Scenario 3: Target Launched from Kodiak Launch Complex, Intercepted from Vandenberg Air Force Base, Pacific Ocean.....	2-44
2.1.8-4	Scenario 4: Target Launched from Pacific Missile Range Facility, Intercepted from Kodiak Launch Complex, Pacific Ocean.....	2-45
2.1.8-5	Scenario 5: Air Launch Target, Intercepted from Kodiak Launch Complex, Pacific Ocean .....	2-46
2.1.8-6	Scenario 6: Sea Launch Target, Intercepted from Kodiak Launch Complex, Pacific Ocean .....	2-47
2.3.1-1	Existing Facilities and Proposed Barge Landing Sites, Kodiak Island, Alaska.....	2-55
2.3.1-2	Existing KLC and Proposed GMD Facilities Layout in South Kodiak Launch Complex .....	2-56
2.3.1-3	Existing KLC and Proposed GMD Facilities Layout in Northeast Kodiak Launch Complex .....	2-57
2.3.1-4	Existing KLC and Proposed GMD Facilities Layout in Northwest Kodiak Launch Complex .....	2-58
2.3.1-5	Existing Integration and Processing Facility—Similar to Proposed Missile Assembly Building.....	2-59
2.3.1-6	Proposed Movable Missile Building.....	2-60
2.3.1-7	Target Missile at Launch Pad.....	2-61
2.3.1-8	TPS-X Radar Radiation Interference Areas .....	2-64
2.3.1-9	Candidate IDT and COMSATCOM Locations, Midway.....	2-66
2.3.1-10	Candidate Ground-Based Midcourse Defense Locations, Meck Island, RTS.....	2-68
2.3.1-11	Reagan Test Site Potential SBX Mooring Area, United States Army Kwajalein Atoll .....	2-69

2.3.1-12	Potential TPS-X Radar Sites, Pacific Missile Range Facility, Kauai, Hawaii.....	2-72
2.3.1-13	Pearl Harbor Potential SBX Mooring Area, Oahu, Hawaii.....	2-75
2.3.1-14	San Nicolas Island Potential SBX Mooring Area, Port Hueneme, California .....	2-76
2.3.1-15	Naval Station Everett Potential SBX Mooring Area, Everett, Washington .....	2-78
2.3.1-16	Port Adak Potential SBX Mooring Area, Adak, Alaska.....	2-79
2.3.1-17	Port of Valdez Potential SBX Mooring Area, Valdez, Alaska .....	2-81
2.3.2-1	Proposed Ground-Based Midcourse Defense Facilities, Vandenberg Air Force Base, California .....	2-83
3.1.2-1	Kodiak Launch Complex Airspace, Kodiak Island, Alaska .....	3-6
3.1.3-1	Map of Major Vegetation Types and Wetlands in the Vicinity of Narrow Cape, Kodiak Launch Complex, Alaska.....	3-8
3.1.3-2	Seabird Colonies and Pinniped Haulout Areas, Kodiak Island, Alaska.....	3-9
3.1.5-1	Principal Faults in the Upper Plate of the Aleutian Subduction Zone Near Kodiak Island, Kodiak Island, Alaska .....	3-17
3.1.9-1	Nearest Sensitive Human Receptors, Kodiak Island, Alaska.....	3-28
3.1.14-1	Major Water Bodies and Sampling Points, Kodiak Launch Complex, Alaska .....	3-40
3.3.2-1	Airspace Over the Potential SBX Site at Reagan Test Site, United States Army Kwajalein Atoll.....	3-54
3.3.2-2	Airspace Managed by the Oakland Oceanic Control Area Administrative Boundaries (Oakland FIR), Pacific Ocean .....	3-55
3.4.2-1	Hawaiian Islands Humpback Whale National Marine Sanctuary Boundary, Hawaiian Islands .....	3-77
3.4.4-1	Pacific Missile Range Facility Health and Safety Areas, Kauai, Hawaii.....	3-83
3.5.2-1	Sensitive Habitat for Listed Wildlife Species on Vandenberg AFB, Northern Vandenberg Air Force Base, California.....	3-94
3.5.4-1	Principal Faults in Vandenberg Air Force Base Area, Vandenberg Air Force Base, California.....	3-100
3.5.6-1	Impact Debris Corridors for a Typical Launch from LF-06 and LF-21, Vandenberg Air Force Base, California.....	3-109
3.5.10-1	Regional and Local Road System, Vandenberg Air Force Base, California .....	3-118
3.5.11-1	Major Streams and Ponds, Vandenberg Air Force Base, California .....	3-120
3.6.2-1	Airspace Over the Potential SBX Mooring Area at Barbers Point, Hawaii, Oahu, Hawaii .....	3-124
3.7.2-1	Airspace Over the Potential SBX Mooring Area at San Nicolas Island, Port Hueneme, California.....	3-135
3.8.2-1	Airspace Over the Potential SBX Site at Naval Station Everett, Everett, Washington .....	3-144
3.9.2-1	Airspace Over the Potential SBX Site at Port Adak, Adak, Alaska .....	3-156
3.10.2-1	Airspace Over the Potential SBX Site at Port of Valdez, Valdez, Alaska.....	3-164
3.11.1-1	Special Use Airspace Over the Gulf of Mexico, Gulf of Mexico .....	3-175
3.11.1-2	En Route Airways and Jet Routes Over the Gulf of Mexico, Gulf of Mexico.....	3-177
3.11.1-3	Aircraft Situation Display of the Gulf of Mexico, Gulf of Mexico .....	3-178
3.11.1-4	Special Use Airspace and Air Routes—Gulf of Mexico to Pacific Ocean.....	3-180
3.11.1-5	Special Use Airspace, Pacific Ocean.....	3-181
3.11.1-6	High Altitude Jet Routes, Pacific Ocean.....	3-182
3.11.2-1	Northwestern Hawaiian Islands Coral Reef Ecosystem Reserve, Open Ocean .....	3-189
3.11.4-1	Density of Shipping—Single Point in Time, Eastern Gulf of Mexico .....	3-194
3.11.4-2	Composite Snapshot of Ship Locations in the Northern Pacific, Open Ocean.....	3-197
4.1.3-1	Wetlands Within the Kodiak Launch Complex and Proposed Facility Locations, Kodiak Island, Alaska.....	4-23



4.1.7-1	Kodiak Joint Tenant Airport and Buskin River State Recreation Site, Kodiak, Alaska .....	4-57
4.1.7-2	Representative Exclusion and Warning Areas, Kodiak Launch Complex, Alaska ....	4-61
4.1.7-3	Flight Safety Corridor Through Forty Seconds of Flight on Flight –Corridor 225 Degrees, Kodiak Island, Alaska .....	4-62
4.1.9-1	Noise Levels for Single Launch, Kodiak Island, Alaska .....	4-80
4.1.9-2	Noise Levels Calculated for Dual Launches, Kodiak Island, Alaska .....	4-81
4.3.2-1	Notional GBR-P Operating Area .....	4-131
4.3.5-1	Launch Protection Circles, Reagan Test Site.....	4-146
4.5.8-1	Noise Levels for a Single Launch (LF-03), Vandenberg Air Force Base, California .....	4-216
4.5.8-2	Calculated Noise Levels of Dual Launches (LF-03 and LF-06), Vandenberg Air Force Base, California.....	4-217
4.8.6-1	North Marina Redevelopment Plan Project Study Area and Potential SBX Locations, Everett, Washington.....	4-260
4.11.1-1	Probability of Fatality Per Cell for 737 (Model Representative Output).....	4-294
4.11.1-2	High Altitude Air Routes with Potential SBX Performance Regions.....	4-298

## TABLES

ES-1A	Impacts and Mitigation Summary, MDA No Action Alternative .....	ES-20
ES-1B	Impacts and Mitigation Summary, MDA No Action Alternative .....	ES-24
ES-2	Impacts and Mitigation Summary, Kodiak Launch Complex .....	ES-26
ES-3	Impacts and Mitigation Summary, Midway.....	ES-30
ES-4	Impacts and Mitigation Summary, Reagan Test Site .....	ES-31
ES-5	Impacts and Mitigation Summary, Pacific Missile Range Facility.....	ES-33
ES-6	Impacts and Mitigation Summary, Vandenberg Air Force Base.....	ES-34
ES-7	Impacts and Mitigation Summary, Pearl Harbor.....	ES-37
ES-8	Impacts and Mitigation Summary, Naval Base Ventura County Port Hueneme ....	ES-38
ES-9	Impacts and Mitigation Summary, Naval Station Everett .....	ES-39
ES-10	Impacts and Mitigation Summary, Port Adak .....	ES-41
ES-11	Impacts and Mitigation Summary, Port of Valdez .....	ES-42
ES-12	Impacts and Mitigation Summary, Broad Ocean Area .....	ES-43
1.8-1	Scoping Meeting Locations and Dates.....	1-9
1.8-2	Number of Comments by Resource Area and Location.....	1-12
1.9-1	Public Hearing Advertisements .....	1-14
1.9-2	Public Hearing Locations, Dates, and Times .....	1-14
1.9-3	Number of Issues by Resource Area and Location.....	1-15
2.0-1	Activities and Locations for the Proposed Action and No Action Alternatives for GMD ETR Testing.....	2-2
2.1.2-1	Extended Test Range Target Missile Data.....	2-6
2.1.4-1	Platform Dimensions .....	2-17
2.1.4-2	Electromagnetic Radiation Potential Interference Distances for SBX .....	2-21
2.1.4-3	SBX Main Beam Altitude at 10 Degree Elevation Operating Level .....	2-21
2.1.4-4	Sea-Based Platform Subelements .....	2-24
2.1.4-5	Sea-Based Test X-Band Radar Mission Activities .....	2-28
2.1.4-6	Sea-Based Test X-Band Radar Test Activities.....	2-29
2.3.1-1	Alternative 1—Existing Facilities to be Used and/or Modified for Ground-Based Midcourse Defense at Kodiak Launch Complex and Vicinity .....	2-52

2.3.1-2	Alternative 1—Proposed New Facilities for Ground-Based Midcourse Defense at Kodiak Launch Complex .....	2-53
2.3.1-3	Alternative 1—Potential Ground Disturbance for Ground-Based Midcourse Defense at Kodiak Launch Complex .....	2-54
2.3.1-4	Existing Facilities Proposed for Ground-Based Midcourse Defense at Meck Island, Ronald Reagan Ballistic Missile Defense Test Site .....	2-70
2.3.1-5	Existing Facilities Proposed for Ground-Based Midcourse Defense at Pacific Missile Range Facility.....	2-71
2.3.1-6	Alternative 1 Existing Facilities Proposed for Ground-Based Midcourse Defense at Vandenberg Air Force Base, California .....	2-73
2.3.2-1	Alternative 2 Existing Facilities Proposed for Ground-Based Midcourse Defense at Vandenberg Air Force Base, California .....	2-84
2.3.2-2	Potential Alternative IDT Sites at Vandenberg Air Force Base, California .....	2-86
2.3.2-3	Alternative 2 Existing Facilities to be Used for Ground-Based Midcourse Defense at Kodiak Launch Complex .....	2-88
2.3.2-4	Alternative 2 Proposed New Facilities for Ground-Based Midcourse Defense at Kodiak Launch Complex .....	2-88
2.3.2-5	Alternative 2 Potential Ground Disturbance for Ground-Based Midcourse Defense at Kodiak Launch Complex .....	2-89
3.1.1-1	Existing Generator Emissions at KLC .....	3-4
3.1.1-2	Estimated Rocket Launch Pollutant Emission Concentrations from Athena-2 at KLC .....	3-04
3.1.3-1	Threatened and Endangered Species in the Kodiak ROI .....	3-11
3.1.5-1	Seismic Source Model, Kodiak Loran Station, Kodiak Island, Alaska .....	3-18
3.1.6-1	Potentially Hazardous Materials Used at KLC .....	3-20
3.1.6-2	Potentially Hazardous Waste Generated at KLC .....	3-21
3.1.9-1	Recorded Noise Levels at Ugak Island During Previous Rocket Launches .....	3-27
3.1.10-1	Kodiak Island Borough Employment Sectors, 2000 .....	3-31
3.1.10-2	Top Ten Kodiak Island Borough Employers, 2000.....	3-31
3.1.14-1	Water Quality on Kodiak Island and in the Vicinity of Kodiak Launch Complex.....	3-41
3.1.15-1	Demographic Comparison Table.....	3-42
3.3.1-1	Ambient Air Quality at Kwajalein Island.....	3-50
3.3.1-2	Summary of Emissions of Regulated Air Pollutants on Kwajalein.....	3-51
3.3.1-3	Summary of Emissions of Regulated Air Pollutants on Meck .....	3-52
3.3.1-4	Estimated Rocket Launch Emissions for a High Level of Activity Launch.....	3-52
3.3.1-5	Summary of Emissions of Regulated Air Pollutants on Roi-Namur.....	3-53
3.4.1-1	Estimated Emissions of Typical Missile Launches at PMRF .....	3-72
3.4.2-1	Listed Species Known or Expected to Occur in the Vicinity of the Proposed Action .....	3-73
3.4.5-1	Employment in Kauai By Sector, 2000.....	3-87
3.5.1-1	Vandenberg AFB and Santa Barbara County Emissions.....	3-91
3.5.2-1	Listed Species Known or Expected to Occur in the Vicinity of the Proposed Action .....	3-92
3.5.4-1	Selected Seismic Sources in Vandenberg AFB Vicinity.....	3-99
3.5.6-1	HQ AFSPC/SG-Recommended and Endorsed Exposure Criteria for Constituents in Rocket Propellant or Motor Exhaust.....	3-107
3.5.8-1	Typical Noise Levels at Vandenberg AFB.....	3-113
3.5.8-2	Measured Titan IV Sound Level, August 1993.....	3-114
3.5.9-1	Employment By Sector, Santa Barbara County, 2000 .....	3-116
3.5.10-1	Peak-Hour Traffic Volumes and Levels of Service on Key Roads—Vandenberg AFB .....	3-117

3.6.1-1	Emissions Recorded Near Barbers Point.....	3-123
3.6.4-1	Pollution Control Discharge Restrictions for Navy Ships.....	3-126
3.7.1-1	Summary of San Nicolas Island Emissions.....	3-134
3.8.1-1	Maximum Measured Pollutant in Naval Station Everett Vicinity.....	3-142
3.8.6-1	Race and Ethnicity, Everett, Snohomish County and Washington State.....	3-148
3.10.1-1	Summary of Emissions of Regulated Air Pollutants in the Port of Valdez.....	3-162
3.10.6-1	Average Daily Traffic Counts on the Richardson Highway for the Year 2000.....	3-170
3.11.2-1	Species with Federal Status Known to Occur in the Gulf of Mexico.....	3-185
3.11.4-1	Top Ten Gulf Ports in 1995 Based on Total Ships.....	3-193
3.11.4-2	1995 Waterborne Tonnage by Gulf Coast States.....	3-195
4.1.1-1	Missile Propellant Information for Previous and Predicted Launches at KLC.....	4-3
4.1.1-2	Existing Generator Emissions at KLC.....	4-3
4.1.1-3	Potential Construction Emissions for GBI Facilities at KLC.....	4-4
4.1.1-4	Potential Exceedances Due to Accidental Oxidizer or Fuel Leak at KLC.....	4-6
4.1.1-5	Potential Generator and Aboveground Storage Tanks for GBI Facilities at KLC.....	4-7
4.1.1-6	Potential Generator Emissions at KLC.....	4-7
4.1.1-7	Propellant Information for Proposed GBI at KLC.....	4-8
4.1.1-8	Potential GBI Stage 1 Exhaust Emissions (Single Launch) at KLC.....	4-8
4.1.1-9	Potential GBI Exhaust Emissions (Dual Launch) at KLC.....	4-9
4.1.1-10	Potential Construction Emissions for Target Facilities at KLC.....	4-10
4.1.1-11	Potential Generator and Aboveground Storage Tanks for Target Facilities at KLC.....	4-11
4.1.1-12	Missile Propellant Information for Proposed Targets at KLC.....	4-12
4.1.1-13	Potential Target Exhaust Emissions (Single Launch) at KLC.....	4-12
4.1.1-14	Potential Peacekeeper Target Exhaust Emissions (Dual Launches) at KLC.....	4-13
4.1.1-15	Potential IDT Construction-Related Emissions at KLC.....	4-14
4.1.1-16	Potential TPS-X Construction-Related Emissions at KLC.....	4-15
4.1.9-1	Noise Levels at KLC from Previous Launches.....	4-76
4.1.9-2	Typical Construction Noises (dBA) at KLC.....	4-77
4.1.9-3	Predicted Noise Levels for Target Launches at KLC.....	4-79
4.1.12-1	Water Requirements for Dual Launch Missile Flight Tests.....	4-100
4.1.12-2	Wastewater Requirements for Dual Launch Missile Flight Tests.....	4-101
4.1.13-1	Scenic Value Class Determined for KLC.....	4-108
4.1.14-1	Total Aluminum and Perchlorate Concentration.....	4-112
4.1.14-2	Estimated Time to Reach 90 Percent Mass Loss of Perchlorate from Propellant Sample.....	4-113
4.2.1-1	Potential Generator Emissions for IDT and COMSATCOM Facilities at Midway....	4-119
4.2.1-2	Potential Generator Emissions for Mobile Telemetry Facilities at Midway.....	4-119
4.3.1-1	Predicted Impacts from Launch Emissions at RTS.....	4-124
4.3.1-2	Predicted Exhaust Emissions at RTS.....	4-125
4.3.1-3	Potential Construction-Related Emissions for Target Facilities at RTS.....	4-126
4.3.1-4	Potential Target Exhaust Emissions at RTS.....	4-127
4.4.1-1	Estimated Emissions of Typical Missile Launches at PMRF.....	4-153
4.4.1-2	Potential Target Exhaust Emissions (Single Launch) at PMRF.....	4-154
4.4.1-3	Possible Generator Emissions for TPS-X Facility at PMRF.....	4-155
4.5.1-1	Missile Propellant Information at Vandenberg AFB.....	4-169
4.5.1-2	Predicted Pollutant Concentration Levels at Vandenberg AFB.....	4-169
4.5.1-3	Vandenberg AFB and Santa Barbara County Emissions.....	4-170
4.5.1-4	Missile Propellant Information for Proposed Targets at Vandenberg AFB.....	4-172
4.5.1-5	Potential Target Exhaust Emissions (Single Launch) at Vandenberg AFB.....	4-172

4.5.1-6	Potential Peacekeeper Target Exhaust Emissions (Dual Launch) at Vandenberg AFB.....	4-173
4.5.1-7	Potential Exceedances Due to Accidental Oxidizer or Fuel Leak at Vandenberg AFB.....	4-175
4.5.1-8	Propellant Information for Proposed GBI at Vandenberg AFB .....	4-176
4.5.1-9	Potential Stage 1 GBI Exhaust Emissions (Single Launch) at Vandenberg AFB ...	4-176
4.5.1-10	Potential GBI Exhaust Emissions (Dual Launch) at Vandenberg AFB .....	4-177
4.5.1-11	Potential Construction Emissions for IDT Facilities at Vandenberg AFB.....	4-178
4.5.1-12	Potential Generator Emissions for IDT Facilities at Vandenberg AFB.....	4-179
4.6.1-1	Emissions Recorded Near Barbers Point.....	4-227
4.6.7-1	Scenic Value Class Determined for Pearl Harbor .....	4-238
4.7.1-1	Summary of San Nicolas Island Emissions.....	4-240
4.8.1-1	Maximum Measured Pollutant in Naval Station Everett Vicinity.....	4-250
4.8.9-1	Scenic Value Class Determined for Naval Station Everett.....	4-265
4.9.7-1	Scenic Value Class Determined for Port Adak.....	4-276
4.10.1-1	Summary of Emissions of Regulated Air Pollutants in the Port of Valdez.....	4-278
4.10.8-1	Scenic Value Class Determined for the Port of Valdez .....	4-289
7-1	Scoping Meeting Locations and Dates.....	7-1
7-2	Number of Comments by Resource Area and Location.....	7-4
8.1-1	Public Hearing Advertisements .....	8-2
8.1-2	Public Hearing Locations.....	8-3
8.1.1-1	Public Comments on the Draft EIS (Written Comments) .....	8-8
8.1.1-2	Responses to Written Comments.....	8-135
8.1.2-1	Public Comments on the Draft EIS (Email Comments).....	8-177
8.1.2-2	Responses to Email Comments .....	8-321
8.1.3-1	Public Comments on the Draft EIS (Public Hearing Comments) .....	8-379
8.1.3-2	Responses to Public Hearing Comments.....	8-515
8.1.4-1	Public Comments on the Draft EIS (Oral Comments).....	8-531
8.1.4-2	Responses to Oral Comments .....	8-591

## EXHIBITS

8.1.1-1	Reproductions of Written Documents.....	8-15
8.1.2-1	Reproductions of Email Documents .....	8-187
8.1.3-1	Reproductions of Public Hearing Documents.....	8-381
8.1.4-1	Reproductions of Oral Documents .....	8-535

---

# 1.0 PURPOSE OF AND NEED FOR THE PROPOSED ACTION

---

1.0	Purpose of and Need for the Proposed Action .....	1-1
1.1	Introduction .....	1-1
1.2	Background .....	1-1
1.3	Purpose of the Proposed Action .....	1-3
1.4	Need for the Proposed Action.....	1-4
1.5	Scope of the Environmental Impact Statement .....	1-4
1.6	Decisions To Be Made .....	1-7
1.7	Cooperating Agencies.....	1-7
1.8	Summary of the Public Scoping Process.....	1-9
1.9	Summary of Draft Environmental Impact Statement Public Review Process.....	1-13
1.10	Related Environmental Documentation .....	1-16

# 1.0 PURPOSE OF AND NEED FOR THE PROPOSED ACTION

---

## 1.1 INTRODUCTION

The National Environmental Policy Act (NEPA) of 1969 as amended (42 United States Code [USC] 4321, *et seq.*), the Council on Environmental Quality (CEQ) Regulations for Implementing the Procedural Provisions of NEPA (40 Code of Federal Regulations [CFR] 1500-1508), Department of Defense (DoD) Instruction 4715.9, *Environmental Planning and Analysis*, and the applicable Service environmental regulations that implement these laws and regulations, direct DoD officials to consider environmental consequences when authorizing and approving federal actions. Accordingly, this Environmental Impact Statement (EIS) examines the potential for impacts to the environment as a result of the proposed construction, operation, and test activities associated with the proposed Ground-Based Midcourse Defense (GMD) Extended Test Range (ETR). Under this Proposed Action, additional test facilities, including the Sea Based Test X-Band Radar (SBX), test equipment, infrastructure, and communications links would be constructed and operated for the purpose of providing more realistic GMD flight testing in the North Pacific Region. Existing range facilities would be enhanced, and additional launch and support sites would be established to support more robust missile flight tests.

## 1.2 BACKGROUND

Within the DoD, the Missile Defense Agency (MDA) (formerly the Ballistic Missile Defense Organization) is responsible for developing and testing a conceptual Ballistic Missile Defense System (BMDS). There are three segments that make up the BMDS: Boost Phase Defense, Midcourse Defense, and Terminal Defense. Each segment of the BMDS is being developed to destroy an attacking missile in the corresponding boost, midcourse, or terminal phase of its flight (see figure 1.2-1). The boost phase is the portion of a missile's flight in which it produces thrust to gain altitude and acceleration. This phase usually lasts between 3 to 5 minutes. During the midcourse phase, which occurs outside much of the Earth's atmosphere for medium- and long-range missiles, the missile coasts in a ballistic trajectory. This phase can last as long as 20 minutes in the case of intercontinental ballistic missiles. During the terminal phase, the missile enters the lower atmosphere and continues on to its target. This phase lasts approximately 30 seconds for intercontinental ballistic missiles. Each segment of the BMDS is composed of one or more elements, each of which consists of an integrated set of technology components, such as interceptors, radars, and communications links, which provide a unique missile defense capability. GMD is one such element.

The MDA's ultimate goal is to develop an integrated BMDS that would be able to destroy an attacking missile in any phase of its flight. However, each prospective element of the different segments of the conceptual BMDS is at a different stage of development and would have a different timetable for integration into the eventual BMDS. Consequently, each element is being designed to provide some capability to defend against an attacking ballistic missile independent of other elements within an overall system. The BMDS development concept is to integrate

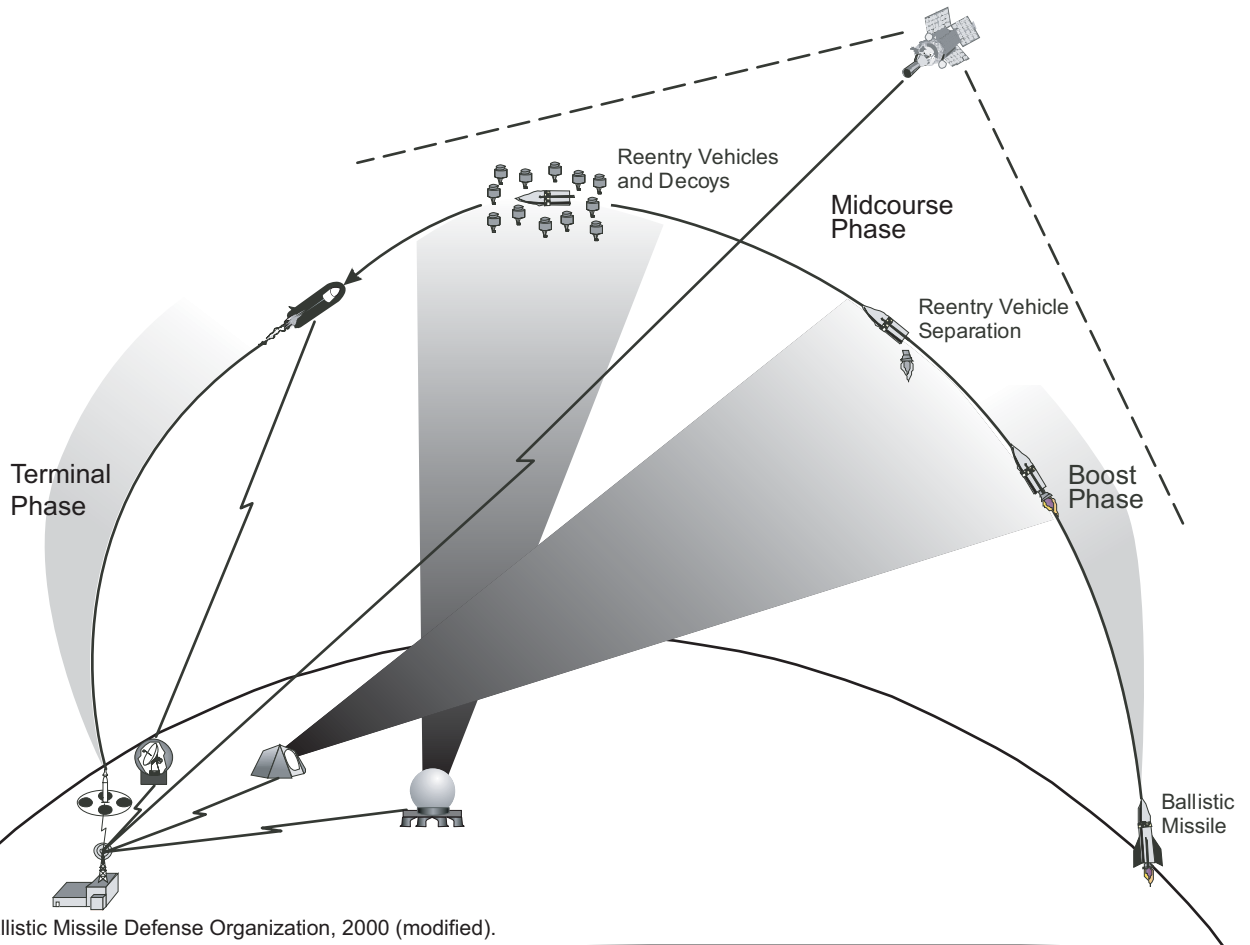
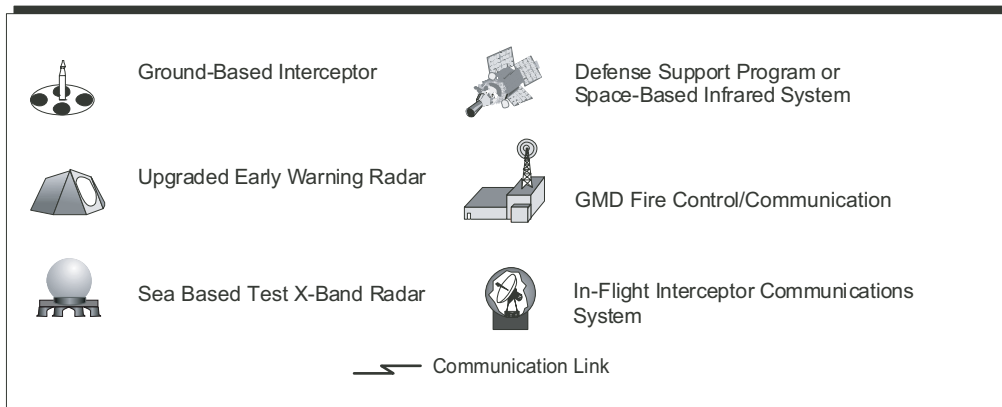

**EXPLANATION**

Note: Locations in this figure are for illustrative purposes only and are notional

**Phases of Ballistic Missile Flight and the Concept for Ground-Based Midcourse Defense**

Not to Scale

**Figure 1.2-1**

promising technologies into BMDS elements as their capabilities are demonstrated through testing.

The GMD Joint Program Office, within the MDA, is responsible for overseeing the development of the GMD element, which is designed to intercept long-range ballistic missiles during the midcourse (ballistic) phase of their flight, before they reenter the Earth's lower atmosphere. An operational GMD element architecture would include the five key components listed below. An illustration of these components, within the concept for GMD testing and operations, is included in figure 1.2-1.

- Ground-Based Interceptors (GBIs)
- X-Band Radar (XBR)
- GMD Fire Control/Communications (GFC/C) facilities and links
- Upgraded Early Warning Radars
- Space-Based Detection Capability

In July 2000, the MDA completed the *National Missile Defense (NMD) Deployment EIS* to support decisions concerning deployment of a GMD (formerly NMD) element (Ballistic Missile Defense Organization, 2000). At the direction of the Secretary of Defense, the MDA refocused the GMD element on operationally realistic testing under the concept of the GMD ETR. This EIS serves to analyze the proposed GMD ETR actions and alternatives for potential impacts on the environment.

On 17 December 2002, President George W. Bush announced plans to begin deployment of an initial set of missile defense capabilities by the year 2004. The MDA proposes to use existing test facilities and infrastructure to the extent possible in fielding these initial capabilities. Consequently, some of the assets proposed for this initial capability could share assets in common with some of those analyzed as part of the GMD ETR. Additional facilities or activities required at Vandenberg Air Force Base (AFB) to support an initial missile defense capability that would not involve test assets are outside the scope of this EIS. A separate NEPA analysis is being prepared to analyze the environmental impacts of fielding this initial capability. Where there may be cumulative environmental effects at Vandenberg AFB from the combined test and initial missile defense capability activities, they will be discussed in the cumulative effects section of this EIS, as applicable.

### **1.3 PURPOSE OF THE PROPOSED ACTION**

The proliferation of weapons of mass destruction and long-range ballistic missile technology is increasing the threat to our national security. The GMD element would defend all 50 states against limited ballistic missile attack. The Secretary of Defense has identified the need to gain a higher level of confidence in the capability of the GMD to defend the United States through more robust interceptor flight tests under more realistic conditions.

The purpose of the Proposed Action is to provide for more realistic flight tests in support of development of the GMD element. The ETR would achieve this by providing additional target



and interceptor launch locations, and sensors, in a wider range of intercept engagements and under more stressing conditions.

## **1.4 NEED FOR THE PROPOSED ACTION**

More realistic testing using trajectories and distances that closely resemble those required of an operational element is needed to ensure the GMD element being developed has the capability to defend the United States against limited missile attacks. To meet this need, the MDA proposes to gain a higher level of confidence in GMD's capabilities to defend the United States through more robust interceptor tests under more realistic conditions.

Currently, the existing test ranges located in the Pacific Region and elsewhere are limited in their capabilities to provide for a geographically dispersed operational environment, suitable for GMD types of testing. As a result, current GMD element testing is constrained by how missile flight tests can be conducted, and in opportunities for multiple engagement scenarios.

## **1.5 SCOPE OF THE ENVIRONMENTAL IMPACT STATEMENT**

The GMD testing would be of two types: (1) validation of the GMD operational concept and (2) more robust GMD element testing. The facilities and operations to validate the GMD operational concept and improve the realism of GMD element testing are each a part of the GMD Test Bed. Each part of the test bed, however, serves a different test function and has independent utility, purpose, and need. The independent parts of the test bed also have different implementation schedules. Consequently, the independent parts of the test bed are being evaluated in separate NEPA analyses. Validation of the operational concept is analyzed in the *Ground-Based Midcourse Defense (GMD) Validation of Operational Concept (VOC) Environmental Assessment (EA)* (U.S. Army Space and Missile Defense Command, 2002a). These actions are designed to validate potential non-launch activities associated with the GMD operational concept by testing the interoperability of the GMD components in a realistic environment. The EA analyzed construction, testing, and support activities at Fort Greely, Clear Air Force Station, and Eielson AFB in central Alaska; Eareckson Air Station on Shemya, Alaska; and Beale AFB, California.

The second type of GMD testing, which is analyzed in this EIS, would involve more robust interceptor flight tests with participation of other GMD components such as SBX and In-flight Interceptor Communication System Data Terminals (IDTs) to achieve more realistic testing. This enhanced ETR flight testing would be accomplished through the extension of existing Pacific Region test range areas that are currently supporting GMD test activities. By extending these test range areas, the realism of GMD testing would be increased through the use of multiple missile engagement scenarios, trajectories, geometries, distances, and speeds of targets and interceptors that more closely resemble those for which an operational system would provide an effective defense. Most tests would include the launch of a target missile; tracking by range and other land-based, sea-based, airborne, and space-based sensors; launch of a GBI; and missile intercepts at high altitudes over the Pacific Ocean. Some test events proposed for later in the program would require multiple target and interceptor missile flights to validate GMD element performance.

Under the proposed GMD ETR concept, target missiles would be launched from Ronald Reagan Ballistic Missile Defense Test Site (RTS) at U.S. Army Kwajalein Atoll (USAKA) in the Marshall Islands; Kodiak Launch Complex (KLC), Alaska; Vandenberg AFB, California; Pacific Missile Range Facility (PMRF) on Kauai, Hawaii; and/or from mobile platforms situated in the North Pacific Ocean. Figure 1.5-1 shows these and other GMD ETR test and test support locations. Interceptor missiles would be launched from RTS, KLC, and/or Vandenberg AFB. Dual target and interceptor missile launches would occur in some scenarios. Existing, modified, or new launch facilities and infrastructure would support these launch activities at the various locations.

Also in support of these launches, missile acquisition and tracking would be provided by existing sea-based sensors, an SBX, and existing land-based sensors in the Pacific Region; a transportable system radar (TPS-X) positioned at Vandenberg AFB, KLC, RTS, or PMRF; the existing prototype XBR at RTS; and existing/upgraded radars at Beale AFB, Clear Air Force Station, and Eareckson Air Station (figure 1.5-1).

IDTs would be constructed at GBI launch sites or placed on a sea-based platform near the proposed GBI launch sites and expected intercept areas or a combination of both. Commercial satellite communications (COMSATCOM) terminals would also be constructed at launch sites that do not have fiber optic communication links and at other locations in the mid-Pacific Region.

Alternative architectures for achieving more realistic interceptor flight tests in the Pacific Region are organized around potential additional interceptor missile launch sites, with other test components being located to provide maximum test effectiveness. For analysis purposes in this EIS, three alternative GMD Test Bed architectures have been identified based on developing additional missile launch capability for GMD testing at:

- (1) KLC and RTS; or
- (2) Vandenberg AFB and RTS; or
- (3) KLC, Vandenberg AFB, and RTS.

A total of approximately 10 launches per year is anticipated for the entire GMD ETR test program. For each of the alternatives, the proposed GMD ETR activities could include up to five missile launches (interceptors and/or targets) from a specific launch facility per year. The GMD ETR activities would be expected to occur over a period of approximately 10 years following a decision to proceed.

In accordance with CEQ Regulations (40 CFR 1502.14(d)), this EIS also analyzes the No Action Alternative, which serves as the baseline from which to compare the alternatives to the Proposed Action. Under the MDA No Action Alternative, the GMD ETR would not be established, and interceptor and target launch scenarios would not be fully tested under operationally realistic conditions. All existing facilities and launch areas, however, would continue current operations, including support of ongoing GMD-related activities. Existing launch sites and test resources would continue to be used in GMD test scenarios whenever practical.

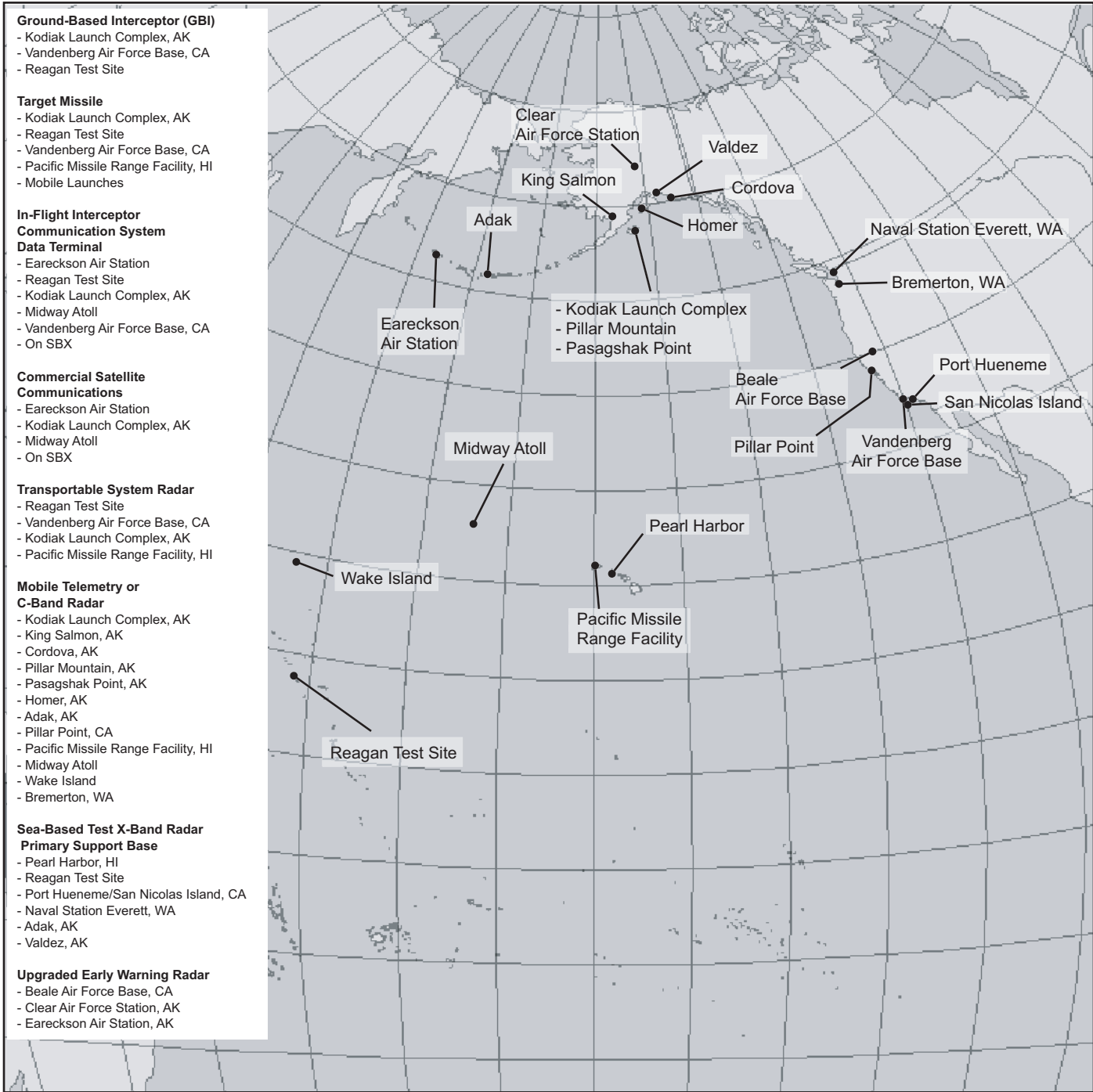

**EXPLANATION**

Note: Although Midway was an alternative site in the Draft EIS, MDA has determined that it is no longer a reasonable alternative and will not be a proposed site for ETR activities. The IDT on-board the SBX would perform the function that had been planned for Midway. The discussion of Midway has been retained in the Final EIS, however, in order to preserve the work that has already been performed.

**Potential GMD ETR Test and Test Support Locations**

Pacific Ocean

**Figure 1.5-1**



The Federal Aviation Administration (FAA) will also rely on this EIS to support a site operator license renewal at KLC. The FAA No Action Alternative would be to not issue a license renewal for KLC.

## **1.6 DECISIONS TO BE MADE**

The initial decision to be made by the MDA is whether to implement the Proposed Action to construct and operate additional GMD test facilities, test equipment, infrastructure, and communication links to enable the MDA to conduct enhanced GMD element testing; or to choose the MDA's No Action Alternative. If the MDA selects the Proposed Action, then a second decision would be made as to which of the three alternative missile launch scenarios and locations would most effectively meet the objectives of the enhanced test program. At the completion of the EIS analysis process, these decisions will be documented in a Record of Decision (ROD), to be published in the *Federal Register*.

The FAA, which is a cooperating agency for this EIS, will also rely on this analysis to support its environmental determination for a launch site operator license renewal at KLC. The FAA's alternatives to be evaluated include renewing the current launch site operator license with no modification as identified in the MDA's No Action Alternative; issuing a license for the list of activities as identified in the MDA's Alternative 1; issuing a license for the list of activities as identified in the MDA's Alternative 2; and FAA's No Action Alternative, which would be to not issue a license renewal for the KLC. For the purposes of the FAA's analysis of proposed activities at KLC, the MDA's Alternative 1 is the same as the MDA's Alternative 3.

At the conclusion of this environmental review process the FAA will issue a separate ROD to support its licensing determination at KLC. The FAA will draw its own conclusions from the analysis presented in this EIS and relevant information contained in the FAA's earlier site license *Environmental Assessment of the Kodiak Launch Complex, Kodiak Island, Alaska* (Federal Aviation Administration, 1996) and assume responsibility for its ROD and any related mitigation measures. Further discussion on this particular issue is provided in section 1.7.

## **1.7 COOPERATING AGENCIES**

In accordance with CEQ Regulations (40 CFR 1501.6), an invitation for cooperating agency status was extended to the FAA for consultation, review, and comment on the EIS. A cooperating agency is an agency with either jurisdiction over a proposed federal action or special expertise about the environmental effects caused by the action.

The FAA, Office of the Associate Administrator for Commercial Space Transportation, is a cooperating agency because of its regulatory authority in licensing the operation of KLC, as defined in 49 USC Subtitle IX—*Commercial Space Launch Activities*, 49 USC 70101-70121, and supporting regulations. The FAA has special expertise and legal responsibility related to the licensing of commercial launch facilities. The FAA is responsible for providing oversight and coordination for licensed launches and protecting the public health and safety, safety of property, and national security and foreign policy interests of the United States. Licensing of launches and reentries, operating a launch or reentry site, or some combination, is considered a federal action

for which environmental impacts must be considered as part of the decision making process as required by NEPA.

Alaska Aerospace Development Corporation (AADC) applied for and was granted a launch site operator license for the operation of KLC in September 1998. A license to operate a launch site remains in effect for 5 years from the date of issuance unless surrendered, suspended, or revoked before the expiration of the term and is renewable upon application by the licensee (14 CFR 420.43, *Duration*). The existing FAA license for the operation of KLC will expire in September 2003.

Should the FAA not reissue a launch site operator's license for KLC to conduct launches, the MDA would be required to choose an alternative that does not include KLC. KLC is the only launch complex evaluated in the EIS that requires a license from the FAA.

An environmental review is just one component of the FAA's licensing process. FAA Order 1050.1D, *Policies and Procedures for Considering Environmental Impacts*, describes the Agency's procedures for implementing NEPA. Specifically, it requires that the FAA decision making process facilitate public involvement by including consideration of the effects of the Proposed Action and alternatives; avoidance or minimization of adverse effects attributable to the Proposed Action; and restoration and enhancement of resources, and environmental quality of the nation. These requirements will be considered in the FAA's licensing decision.

In addition to the environmental review and determination, applicants must complete a policy review and approval, safety review and approval, payload review and determination, and a financial responsibility determination. The purpose of the Policy Review and Approval process is to determine whether or not the information in the license application presents any issues affecting U.S. national security or foreign policy interests, or international obligations of the United States. The purpose of the Safety Review and Approval process is to determine whether an applicant can safely conduct the launch of the proposed launch vehicle(s) and any payload. The purpose of the Payload Review and Determination is to determine whether a license applicant or payload owner or operator has obtained all required licenses, authorization, and permits. The purpose of the Financial Responsibility Determination is to ensure that all commercial licensees demonstrate financial responsibility to compensate for the maximum probable loss from claims by a third party for death, bodily injury, or property damage or loss resulting from an activity carried out under the license; and the U.S. Government against a person for damage or loss to government property resulting from an activity carried out under the license. All of these reviews, including the environmental review, must be completed prior to issuing a license. All FAA safety analyses would be conducted separately and would be included in the terms and conditions of the license.

A license to operate a launch site authorizes a licensee to offer its launch site to a launch operator for each launch point for the type and weight class of launch vehicle identified in the license application and upon which the licensing determination is based. Issuance of a license to operate a launch site does not relieve a licensee of its obligation to comply with any other laws or regulations, nor does it confer any proprietary, property, or exclusive right in the use of airspace or outer space (14 CFR 420.41).

## 1.8 SUMMARY OF THE PUBLIC SCOPING PROCESS

The CEQ Regulations implementing NEPA require an open process for determining the scope of issues related to the Proposed Action and its alternatives. Comments and questions received, as a result of this process, assist the DoD in identifying potential concerns and environmental impacts to the human and natural environment.

The GMD ETR EIS public scoping period began on 28 March 2002, when the Notice of Intent to prepare an EIS was published in the *Federal Register*. The scoping comment period was originally scheduled to end on 10 May 2002, but was extended to 20 May 2002 in response to public request. Subsequently, inclusion of the SBX in the EIS analysis extended scoping and the comment period even further, through 20 December 2002.

A number of methods were used to inform the public about the GMD ETR Program and of the locations of the scheduled scoping meetings. These included:

- The Notice of Intent announcement in the *Federal Register*
- Paid advertisements in local and regional newspapers

Public scoping meetings were held at the locations listed in table 1.8-1. During these public scoping meetings, attendees were invited to ask questions and make comments to the program representatives at each meeting. In addition, written comments were received from the public and regulatory agencies at the scoping meeting, and by letter and e-mail during the extended comment period. Comments received from the public and agencies pertaining to specific resource areas and locations were considered, and more detailed analysis was provided in the EIS. Those comments received from the public concerning DoD policy and program issues are outside the scope of what is required to be analyzed in an EIS.

**Table 1.8-1: Scoping Meeting Locations and Dates**

Meeting Location	Date
Kodiak, Alaska—Kodiak High School	16 April 2002
Anchorage, Alaska—Egan Convention Center	18 April 2002
Lompoc, California—Town Hall Council Chambers	25 April 2002
Honolulu, Hawaii—Best Western Hotel	18 September 2002
Seattle, Washington—Hilton Conference Center	17 October 2002
Oxnard, California—Public Library	22 October 2002
Port of Valdez—Valdez Civic Center	19 November 2002
Port Adak—Bob Reeves High School	5 December 2002

## **Native Village Meetings**

A series of village coordination meetings was held on Kodiak Island in June and July 2002 in partial fulfillment of a pledge from the GMD Joint Program Office to reach out to Native residents to explain the Proposed Action at KLC. The team visited the villages of Akhiok, Ouzinkie, Port Lions, Afognak, Kodiak, and Larsen Bay.

Several generic issues were raised, including the following:

- The environmental consequences of flying rockets from KLC
- The inquiry from the Village of Old Harbor about the need for a fallout shelter
- Job opportunities associated with the Proposed Action
- Most village attendees expressed feelings of patriotism and support for what was being planned

## **Agency Meetings**

An agency meeting was held in the offices of the Alaska Division of Governmental Coordination in Anchorage in April 2002 to provide an overview of the Proposed Action to the represented agencies and to solicit input on the EIS. Agencies represented at this meeting included the U.S. Fish and Wildlife Service (USFWS), the Alaska Department of Fish and Game, the U.S. Army Corps of Engineers, the U.S. Coast Guard, and the Alaska Department of Natural Resources. Some of the comments from the agencies are listed below:

- The USFWS recommended that an alternative site to the current proposed launch site at KLC should also be considered, if possible, because this ridge area is a sensitive area and there are public use concerns.
- The agencies requested more detailed information regarding the Proposed Action and alternatives.
- A trip with the agencies to the proposed construction site at Kodiak was suggested and agreed upon for the near future.
- A trip to Kodiak was conducted in May of 2002. The USFWS was the only agency in attendance. After reviewing the proposed KLC sites, the concern over the ridge area noted during the meeting was lessened and the visit focused on visual impacts.

An additional agency meeting was held in the offices of the Alaska Division of Governmental Coordination Offices in Anchorage in November 2002 to provide additional information regarding the potential siting of the SBX at Adak or the Port of Valdez, and to solicit input on the Coordinating Draft EIS. Agencies represented included the Alaska Department of Environmental Conservation, the U.S. Army Corps of Engineers, and the Alaska Department of Natural Resources. Some of the comments from the agencies are listed below:

- Migratory bird site adjacent to Valdez is an Aquatic Resource of National Importance. Air quality is a potential concern.
- Valdez Narrows is closed when a tanker is passing through.

- An Alaska Department of Natural Resources permit would be required for all actions within 4.8 kilometers (3 miles) of the shore. This would include barge landing sites and mooring sites. Mooring sites would also require a Section 10 Permit.
- Need to add Standard Operating Procedures (SOPs) for debris recovery in case of an accident at KLC, since this operation would have the highest probability for perchlorate contamination.

An agency meeting was held in Honolulu in September 2002 with representatives from the USFWS and the FAA. This meeting centered primarily on the potential siting of the SBX at Pearl Harbor. Some of the comments from the agencies included:

- Questions from the FAA on the proposed operation of the radar and the effects of radiological hazards and interference with air traffic at the Honolulu International Airport
- Questions from the USFWS mainly concerning the effects of the radar on bird populations

An agency meeting was also held at Naval Station Everett in October 2002 with representatives from the State of Washington and the U.S. Navy. Some of the comments included:

- Questions on the proposed operation of the radar, potential radiological hazards, and interference with ship traffic
- Questions on the potential introduction of foreign species into open water
- Questions on the effects of the SBX on seabirds, shorebirds, federally threatened fish species, and widely distributed open water species such as whales and turtles

### **Results of Public Scoping Meetings**

The public scoping meetings used an information/exhibit format with a formal presentation on the GMD Program Overview and the Environmental Analysis Process. A sampling of some of the comments expressed by the public included:

- Concern about the chemicals in the air and the harm that they will do to the environment
- Concern about the pristine fisheries and wilderness, and belief that a thorough investigation of the effects of launch activities should occur in the EIS
- Concern that the EIS could never fully address all the short- and long-term impacts around KLC
- Concern about the expansion of KLC, since the facility is located in a seismically active area
- Concern about putting valuable resources of Kodiak Island at risk due to toxic substances integral to missile launch operations
- Concern with the hazardous materials that are released in the explosion of a rocket, in flight, on the pad, or in a launch silo; the EIS should address the effects of all potential rocket fuels and payloads



- Concern about the safety of the Proposed Action
- Concern about the health hazards from radars such as the X-band
- Concern that mobile telemetry radars will not be limited to the roads and will be taken into sensitive areas and damage will occur to the land
- Concern that GMD is expensive and will require cuts in funding for human services
- Opposition to the U.S. Government's plan for continuing research and development of the Missile Defense Program
- A desire that additional work be done on measuring the cumulative impacts to the environment
- Concern that the Narrow Cape road on Kodiak Island will be closed

Table 1.8-2 summarizes the number of comments received from the public at the scoping meetings, and from other sources, for each resource category.

**Table 1.8-2: Number of Comments by Resource Area and Location**

Resource Area	Kodiak, AK	Anchorage, AK	Lompoc, CA	Honolulu, HI	Seattle, WA*	Oxnard, CA	Valdez, AK	Adak, AK	Other	Total
Air Quality	3		1						1	5
Airspace Use		1	1						1	3
Biological Resources	3	2	3							8
Cultural Resources		1								1
EIS Process	20	14	1						1	36
Environmental Justice										0
Geology and Soils	10	2								12
Hazardous Materials and Hazardous Waste	14	4	1				1			20
Health and Safety	14	7	3				2		5	31
Land Use and Aesthetics	6	6								12
Noise		2								2
Policy	5	6							205	216
Program	14	20	3	2		6	8	3	80	136
Socioeconomics	1	5	1			2	2		12	23
Subsistence	8	3								11
Transportation	4	2					3			9
Utilities										0
Water Resources	6		2							8
Other	6	17	2				1	4	2	32
<b>TOTAL</b>	<b>114</b>	<b>92</b>	<b>18</b>	<b>2</b>	<b>0</b>	<b>8</b>	<b>17</b>	<b>7</b>	<b>307</b>	<b>565</b>

\* Note: No comments were received at the Seattle scoping meeting

## 1.9 SUMMARY OF DRAFT ENVIRONMENTAL IMPACT STATEMENT PUBLIC REVIEW PROCESS

The public review and comment period began with the publication of a Notice of Availability (NOA) for the GMD ETR Draft EIS, published in the *Federal Register* on Friday, 7 February 2003, by the Missile Defense Agency and the Federal Aviation Administration. This initiated a review period for the public and interested agencies to review the Draft EIS and submit their comments. Copies of the Draft EIS were made available for review in local libraries in the areas affected and were provided to those who requested a copy of the EIS. Copies of the Draft EIS were available on the MDA website and were placed in the following public libraries:

- Oxnard Public Library, 251 S. A St., Oxnard, CA 93030
- Kodiak City Library, 319 Lower Mill Bay Rd., Kodiak, AK 99615
- Lompoc Public Library, 501 E North Ave., Lompoc, CA 93436
- Anchorage Municipal Library, 3600 Denali St., Anchorage, AK 99503
- Mountain View Branch Library, 150 S. Bragaw St., Anchorage, AK 99508
- Valdez City Library, 212 Fairbanks, Valdez, AK 99686
- Everett Library, 2702 Hoyt Ave., Everett, WA 98201
- Hawaii State Library, Hawaii Documents Center, 478 South King St., Honolulu, HI 96813
- University of Hawaii at Manoa, Hamilton Library, 2550 The Mall, Honolulu, HI 96822

In conjunction with the Draft EIS review process, seven public hearings were held from 24 February 2003 to 6 March 2003. Detailed information on locations and times for each of the public hearings was published in local and regional newspapers (table 1.9-1) 2 weeks in advance, and public-service announcements and press releases were provided to radio and television stations.

The purpose of the public hearings was to solicit public comments on the environmental areas analyzed and considered in the Draft EIS and to identify environmental issues that the public and Government agencies consider to need further analysis. Chapter 8.0 of this EIS contains a reproduction of the transcripts of the public hearings and responses to comments. Table 1.9-2 lists the location, date, times and number of attendees at the public hearings.

In addition to the public hearings, the public could make comments through a 1-800 telephone number, by sending an email, or by sending a written comment. Chapter 8.0 of this EIS contains a reproduction of the telephone, email, and written comments and responses to those comments. Issues identified by the public were provided to resource specialists working on the Final EIS to ensure that all comments were considered during the preparation of the final document. Table 1.9-3 presents a summary of the number of issues identified for each resource area by location.

**Table 1.9-1: Public Hearing Advertisements**

<b>Newspaper</b>	<b>Public Hearing Location</b>	<b>Dates</b>
<i>The Seattle Times</i>	Everett, WA	10, 16, 23 February 2003
<i>The Bremerton Sun</i>	Everett, WA	9, 16, 23 February 2003
<i>The Everett Herald</i>	Everett, WA	9, 16, 23 February 2003
<i>The Lompoc Record</i>	Lompoc, CA	9, 16, 23 February 2003
<i>The Santa Barbara News</i>	Lompoc and Oxnard, CA	Lompoc: 9, 16, 23 February 2003 Oxnard: 12, 16, 23 February 2003
<i>Ventura County Star</i>	Lompoc and Oxnard, CA	Lompoc: 18, 21, 23, 25 February 2003 Oxnard: 9, 16, 23 February 2003
<i>Kodiak Daily Mirror</i>	Kodiak, AK	5, 21, 24 February 2003
<i>Anchorage Daily News</i>	Anchorage, AK	9, 16, 23 February 2003
<i>Valdez Vanguard</i>	Valdez, AK	19, 26, 27 February 2003
<i>Valdez Star</i>	Valdez, AK	12, 19, 26 February 2003
<i>The Honolulu Star-Bulletin</i>	Honolulu, HI	Daily newspaper: 23, 26 February 2003 2 March 2003 Mid-week newspaper: 5 March 2003
<i>The Honolulu Advertiser and The Island Weekly</i>	Honolulu, HI	16, 21, 23 February 2003 27 February 2003
<i>Office of Environmental Quality Control (OEQC) Bulletin</i>	Honolulu, HI	23 February 2003

**Table 1.9-2: Public Hearing Locations, Dates, and Times**

<b>Location</b>	<b>Date</b>	<b>Times</b>	<b>Public Attendees</b>
Oxnard Public Library, Oxnard, CA	24 February 2003	6:00-8:00 p.m.	48
Kodiak High School, Kodiak, AK	24 February 2003	6:00-9:00 p.m.	32
Lompoc City Council Chambers, Lompoc, CA	25 February 2003	6:00-9:00 p.m.	25
Egan Convention Center, Anchorage, AK	25 February 2003	6:00-9:00 p.m.	38
Valdez Convention Center, Valdez, AK	26 February 2003	6:00-9:00 p.m.	8
Everett Holiday Inn, Everett, WA	27 February 2003	6:00-9:00 p.m.	78
Disabled American Veterans Hall, Keehi Lagoon Park, Honolulu, HI	6 March 2003	6:00-9:00 p.m.	26

**Table 1.9-3: Number of Issues by Resource Area and Location**

<b>Resource Area</b>	<b>Oxnard</b> # of Issues	<b>Lompoc</b> # of Issues	<b>Everett</b> # of Issues <sup>2,3</sup>	<b>Anchorage</b> # of Issues	<b>Kodiak</b> # of Issues	<b>Valdez</b> # of Issues	<b>Honolulu</b> # of Issues <sup>1</sup>	<b>Midway</b> # of Issues	<b>Total</b> # of Issues	<b>% of Issues</b> <sup>4</sup>
<b>Air Quality</b>	1		30	1	1		1		34	1%
<b>Airspace Use</b>	4		126	2			180		312	6%
<b>Biological Resources</b>	6		31	3	13		676	7	736	13%
<b>Cultural Resources</b>				2	1		4		7	0%
<b>EIS Process</b>	5	3	102	5	2		872	2	991	18%
<b>Environmental Justice</b>					1	1	337		339	6%
<b>Geology and Soils</b>					5				5	0%
<b>Hazardous Materials/Waste</b>	2		7		1		2		12	0%
<b>Health and Safety</b>	2	2	268	5	11		352		640	12%
<b>Land Use</b>	1		1	4	13		169	1	189	3%
<b>Noise</b>			7						7	0%
<b>Policy</b>	9	4	23	8	4		20		68	1%
<b>Program</b>	48	7	1,024	22	25	4	526	5	1,661	30%
<b>Socioeconomics</b>	1		334	2	7	1	1		346	6%
<b>Transportation</b>			14	2	3		2		21	0%
<b>Utilities</b>	2		3			2			7	0%
<b>Visual Aesthetics</b>	3		82				2		87	2%
<b>Water Resources</b>					1			1	2	0%
<b>Total</b>	<b>84</b>	<b>16</b>	<b>2,052</b>	<b>56</b>	<b>88</b>	<b>8</b>	<b>3,144</b>	<b>16</b>	<b>5,464</b>	<b>100%</b>

Notes:

1. Same email from 169 individuals x 19 issues = 3,211 issues
2. Similar written comments from 140 individuals = 577 issues
3. Petition entered as one comment, includes 764 signatures
4. A "0" in the percent column indicates less than one percent

## **1.10 RELATED ENVIRONMENTAL DOCUMENTATION**

A number of other EAs and EISs have previously been prepared to support the development of the specific technologies that may be used as part of the GMD element. The information and analyses contained in these NEPA documents were used in the development of this EIS. Several of the documents have been incorporated by reference and are cited in the EIS where applicable. Appendix A includes a brief overview of each of these NEPA documents as well as a link to a website where the documents can be viewed.

Additional environmental documentation would be completed following completion of the GMD ETR EIS. A separate NEPA analysis is being prepared to analyze the environmental impacts of fielding an initial missile defense capability at Vandenberg AFB. Appendix E includes information on permits, licenses, and entitlements that would be required before the proposed actions could proceed.

---

## 2.0 DESCRIPTION OF PROPOSED ACTION AND ALTERNATIVES

---

2.0	DESCRIPTION OF PROPOSED ACTION AND ALTERNATIVES.....	2-1
2.1	GMD Extended Test Range Components and Operations.....	2-3
2.1.1	Ground-Based Interceptor Systems.....	2-3
2.1.2	Target Missile Systems.....	2-5
2.1.3	In-Flight Interceptor Communication System Data Terminal Options .....	2-13
2.1.4	Sea-Based Test X-Band Radar .....	2-17
2.1.5	Test Range Sensors and Support Instrumentation.....	2-29
2.1.6	Flight Test Planning and Operations.....	2-34
2.1.7	Flight Test Safety .....	2-39
2.1.8	Flight Test Example Scenarios .....	2-41
2.2	No Action Alternative.....	2-48
2.2.1	Launch Sites and Other Support Facilities .....	2-48
2.2.2	Mobile GMD System Elements .....	2-50
2.3	Proposed Action.....	2-50
2.3.1	Alternative 1 .....	2-51
2.3.2	Alternative 2 .....	2-82
2.3.3	Alternative 3—Combination of Alternatives 1 and 2 .....	2-90
2.4	Alternatives Considered But Not Carried Forward.....	2-90
2.4.1	GBI Launch Location Alternatives.....	2-90
2.4.2	Target Launch Location Alternatives .....	2-91
2.4.3	IDT Location Alternatives .....	2-91
2.4.4	Sea-Based Test X-Band Radar Primary Support Base Alternatives .....	2-91
2.4.5	Mobile Telemetry and Mobile C-Band Radar Location Alternatives .....	2-92

## 2.0 DESCRIPTION OF PROPOSED ACTION AND ALTERNATIVES

---

The Proposed Action is to construct and operate additional launch and test facilities in the Pacific Region, and to conduct more realistic GMD element tests in support of GMD development. The extension of existing U.S. test ranges would increase the realism of GMD testing by using multiple engagement scenarios, trajectories, geometries, distances, and speeds of targets and interceptors that more closely resemble those for which an operational system would provide an effective defense. The GMD ETR testing would include pre-launch activities, launch of targets and GBIs from a number of widely separated locations, and missile intercepts over the Pacific Ocean.

For the purpose of this EIS, a flight test or test event represents a target missile flight, an interceptor missile flight, an intercept of a target missile, or a test of some sensor(s) independent of a missile flight test. Most tests would include the launch of a target missile; tracking by range and other land-based, sea-based, airborne, and space-based sensors; launch of an interceptor missile; target intercept; and debris impacting into broad open areas of the Pacific Ocean. Some test events proposed for later in the program would require multiple target and/or interceptor missile flights to validate GMD system performance. A total of approximately 10 launches per year is anticipated for the entire GMD ETR test program. For each of the alternatives, the proposed GMD ETR activities could include up to five missile launches (interceptors and/or targets) from a specific launch facility per year. The GMD ETR testing activities would likely occur over a period of approximately 10 years following a decision to proceed.

The alternatives for implementing the Proposed Action represent architectures for achieving more realistic interceptor flight tests in the Pacific Region. These architectures are organized around potential additional GBI missile launch sites, with other new and existing test components being located to provide maximum test effectiveness. For analysis purposes in this EIS, three alternative test architectures have been identified based on developing additional launch capability at (1) KLC and RTS, (2) Vandenberg AFB and RTS, and (3) KLC, Vandenberg AFB, and RTS. Each alternative test architecture would include common GMD test components consisting of GBIs, target missiles, IDTs, the SBX, and other sensors and instrumentation.

In addition to the alternatives for the Proposed Action, this EIS also considers the No Action Alternative. Under the No Action Alternative, the GMD ETR would not be established, and additional facilities and components to be used in ETR operations would not be built. Existing launch sites and test range activities, however, would continue at the various locations, including support of ongoing GMD test activities.

Table 2.0-1 lists the test activities and components associated with the alternatives for implementing the Proposed Action. Those actions and components that would be conducted under the No Action Alternative are also included. In the discussions following table 2.0-1, section 2.1 describes the GMD ETR components (i.e., GBIs, target missiles, the SBX, IDTs, and other sensors and instrumentation) and pre-flight/flight test operations that would normally

**Table 2.0-1: Activities and Locations for the Proposed Action and No Action Alternatives for GMD ETR Testing**

Activity	No Action Alternative	Proposed Action (Establish and Operate the GMD ETR)		
		Alternative 1	Alternative 2	Alternative 3
GBI Silo or Launch Pad Construction	None	KLC	—	KLC
Support Facility Construction	None	KLC	KLC	KLC
Silo/Support Facility Modification	None	KLC VAFB	KLC VAFB	KLC VAFB
Target Launch Pad Construction	None	KLC	KLC	KLC
Target Launch Pad Modification	None	KLC RTS	KLC RTS	KLC RTS
IDT Construction and Operation plus Mission Communications	Eareckson Air Station RTS	KLC Midway <sup>3</sup> Sea-based RTS	VAFB Midway <sup>3</sup> Sea-based RTS	KLC VAFB Midway <sup>3</sup> Sea-based RTS
COMSATCOMs	Eareckson Air Station <sup>4</sup>	KLC Midway <sup>3</sup>	Midway <sup>3</sup>	KLC Midway <sup>3</sup>
TPS-X Radar	RTS VAFB	KLC PMRF RTS VAFB	KLC PMRF RTS VAFB	KLC PMRF RTS VAFB
Mobile Telemetry	KLC Cordova, AK Pillar Point, CA	KLC Pasagshak Point, AK Homer, AK King Salmon, AK Adak, AK Cordova, AK Pillar Mountain, AK Pillar Point, CA Midway Bremerton, WA	KLC Pasagshak Point, AK Homer, AK King Salmon, AK Adak, AK Cordova, AK Pillar Mountain, AK Pillar Point, CA Midway Bremerton, WA	KLC Pasagshak Point, AK Homer, AK King Salmon, AK Adak, AK Cordova, AK Pillar Mountain, AK Pillar Point, CA Midway Bremerton, WA
GBI Launch (1 = single, 2 = dual)	RTS (2) VAFB (2) <sup>1</sup>	KLC (2) RTS (2)	VAFB (2) RTS (2)	KLC (2) VAFB (2) RTS (2)
Target Launch (1 = single, 2 = dual)	KLC (1) PMRF (1) VAFB (1) Mobile (1) <sup>2</sup>	KLC (2) PMRF (1) RTS (2) VAFB (2) Mobile (1) <sup>2</sup>	KLC (2) PMRF (1) RTS (2) VAFB (2) Mobile (1) <sup>2</sup>	KLC (2) PMRF (1) RTS (2) VAFB (2) Mobile (1) <sup>2</sup>
SBX	None	Broad Ocean Area Primary Support Base	Broad Ocean Area Primary Support Base	Broad Ocean Area Primary Support Base

Note: KLC Kodiak Launch Complex PMRF Pacific Missile Range Facility  
RTS Reagan Test Site VAFB Vandenberg Air Force Base

<sup>1</sup> Booster Verification tests, no intercepts

<sup>2</sup> Mobile–Air or Sea Launch

<sup>3</sup> Midway – Although Midway was an alternative site in the Draft EIS, MDA has determined that it is no longer a reasonable alternative and will not be a proposed site for ETR activities. The IDT on-board the SBX would perform the function that had been planned for Midway. The discussion of Midway has been retained in the Final EIS, however, in order to preserve the work that has already been performed.

<sup>4</sup> Military Satellite Communications at Eareckson Air Station



occur. Section 2.2 identifies the major activities, components, and locations involved in conducting the No Action Alternative. Section 2.3 describes the locations for implementing each of the Proposed Action alternatives. Lastly, section 2.4 describes those alternatives considered, but not carried forward in this analysis.

## 2.1 GMD EXTENDED TEST RANGE COMPONENTS AND OPERATIONS

The sections that follow provide a detailed description of the GMD ETR components to be used in program testing. Where applicable, facility and component construction and developmental requirements are described. A discussion on GMD pre-flight and flight test operational requirements is also included.

### 2.1.1 GROUND-BASED INTERCEPTOR SYSTEMS

The GBI is the “weapon” of the GMD element that would be used in GMD ETR testing. Its mission is to intercept incoming ballistic missile warheads outside the Earth’s atmosphere and destroy them by force of impact. The GBI missile consists of a three-stage solid propellant booster and an Exoatmospheric Kill Vehicle (EKV) (figure 2.1.1-1). The GBI is approximately 16 meters (54 feet) long and 1.3 meters (4.2 feet) in diameter, and it weighs approximately 20.4 to 22.7 metric tons (22.5 to 25 tons).

For the purposes of analysis, each interceptor booster is assumed to contain approximately 20,500 kilograms (45,000 pounds) of solid propellant, and each EKV is assumed to contain approximately 7.5 liters (2 gallons) of liquid fuel and 5.5 liters (1.5 gallons) of liquid oxidizer. These liquid propellants would consist of a form of monomethyl hydrazine and nitrogen tetroxide, respectively. The liquid fuel and liquid oxidizer tanks would arrive at the site fully fueled. For this analysis, it is assumed that the interceptor (booster stages and EKV) would be assembled at the test sites.

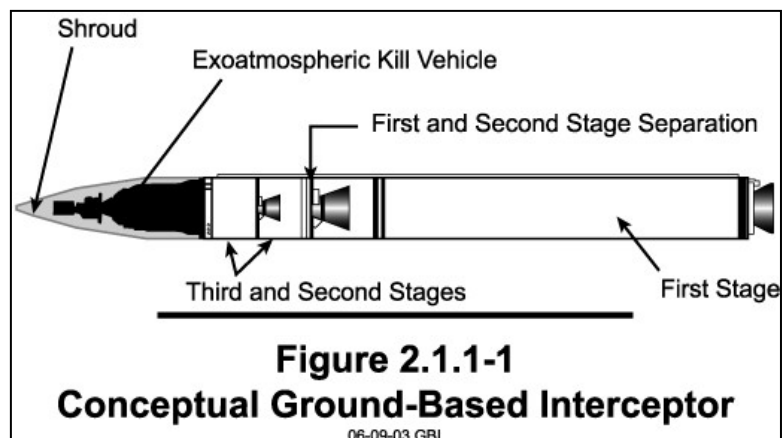

The components associated with a typical GBI launch site include the Launch Control Center, range sensors, and IDT. Commercial power would be used during missile flight tests, with a generator serving as backup.

#### 2.1.1.1 Ground-Based Interceptor Transportation, Handling, and Facilities

Interceptor missile boosters, payloads, and support equipment would be transported by air, ship, or over-the-road common carrier truck from U.S. Government storage depots or contractor facilities to the test range. All shipping would be conducted in accordance with Department of Transportation (DOT) regulations. The interceptor would be placed in existing or proposed new facilities for assembly and launch preparation. Applicable safety regulations would be followed in the transport, receipt, storage, and handling of hazardous materials. A small quantity of liquid propellants (approximately 7.5 liters [2 gallons] of liquid fuel and 5.5 liters [1.5 gallons] of liquid

oxidizer) would be used by the EKV. Presently, there are no plans to store liquid propellants onsite other than the preloaded fuel and oxidizer tanks that would be installed on the EKV. The interceptor may arrive at the test range with the EKV attached, or the booster may be shipped separately from the EKV. In either case, the fuel and oxidizer tanks would be installed in the EKV and the helium tanks on the EKV would be pressurized at the test site. If the booster is shipped separately from the EKV, integration and assembly operations would be performed onsite.

An appropriate explosive safety quantity–distance (ESQD) would be established around facilities where interceptors and ordnance are stored or handled as approved by the DoD Explosives Safety Board.

Maximum use would be made of existing infrastructure and facilities at launch sites. Existing facilities would be modified as necessary to support interceptor missile system operations. Additional infrastructure requirements may include onsite road improvements, fencing, electrical service, potable water, and telephone and data transmission lines.

At some locations, new GBI silos or a launch pad would be required. The silos would be approximately 3 meters (10 feet) in diameter and 21 meters (70 feet) long (deep). The pad, if required, would be approximately 53.3 by 53.3 meters (175 by 175 feet).

#### **2.1.1.2 Ground-Based Interceptor Launch Support Operations**

Portable equipment used to support interceptor missile testing may include telemetry vans, personnel trailers, and power generators. For the GBI launch site, a typical launch cycle ramp-up would include 55 to 65 people during the first month, 100 to 130 people during the second month, and 205 to 260 people during the third month. Dual launch would include approximately 55 to 65 people during the first month, 120 to 150 people during the second month, and 235 to 300 people during the third month. After a launch, approximately 75 personnel would depart immediately. Personnel would include contractors, military, and U.S. Government civilians.

The GBI operations at the test site may include missile assembly and checkout, installation of the EKV bi-propellant tanks onto the EKV, inspection of the tanks after installation, final inspections, testing and checkout of the loaded EKV assembly, integration of the EKV with the booster, and placement of the interceptors into the silo(s). The EKV may be integrated with the booster in the silo, or it may be integrated with the third booster stage before integration with the remainder of the boosters.

The GMD testing would use dedicated utilities for environmental control of the silos, and activities associated with testing. An offsite commercial supplier would supply primary power to the site, but a backup battery system and onsite backup diesel generators would supply emergency power. Generators for various GBI-related facilities would range in output from approximately 75 to 900 kilowatts (kW). Each generator would also have its own dedicated aboveground fuel storage tank. These dedicated tanks would range in capacity from approximately 15,140 to 75,710 liters (4,000 to 20,000 gallons).

### **2.1.1.3 Ground-Based Interceptor Security**

When interceptor testing occurs, it would be on a campaign basis, and the security for these tests would be on a similar basis. It is estimated that security related activities would occur for approximately 5 weeks for each campaign.

Security requirements would vary for each potential launch location. A program of continuous protection activities would take place during each campaign, such as monitoring the Intrusion Detection System, operating the base station for the security radio system, guard training, providing daily instructions for guards, and making security badges for those who come to the site.

The existing Intrusion Detection System may be expanded as necessary to include all critical buildings associated with GMD operations. This expansion may include the installation of additional intrusion sensors, lighting, closed circuit television, and a monitor for the sensors.

Additional physical protection features may be constructed or placed to protect GMD assets. These may include, but are not limited to, fences, security lighting, bollards, tapered concrete barriers or similar devices, ditching and/or earth mounds, patrol roads, and observation tower(s).

Security vehicles may be on patrol day and night. Each vehicle would have radio equipment that would be in operation while on patrol. Normal patrols would be confined to existing roads. There may be occasions when these vehicles can be expected to go off road.

Public access would be limited in the vicinity of GBI missile storage, handling, and launch facilities.

## **2.1.2 TARGET MISSILE SYSTEMS**

The purpose of target missiles in GMD testing is to provide realistic targets for testing new and evolving GMD interceptor missile and sensor systems. Targets would be used to validate the capabilities of GMD interceptor systems. Targets typically simulate the expected threat, both in physical size and performance characteristics. Target missiles may be launched from fixed land locations, sea launch vessels, or aircraft.

### **2.1.2.1 Target Missiles**

A typical GMD target missile consists of a launch vehicle (booster) and a payload that may include a target reentry vehicle, guidance and control electronics, decoys, and other countermeasures. The target missile would deliver the target reentry vehicle in a variety of configurations. A booster may consist of one or more stages. A stage refers to the number of rocket motors which sequentially activate. Multiple stages allow the missile to fly at higher velocities and altitudes, and for longer distances. Specific target missiles that may be used in ETR flight testing are described in the following sections and in table 2.1.2-1. These target missiles are meant to represent a class or range of targets. Figure 2.1.2-1 shows a comparison of the representative launch vehicles and target missiles and identifies the existing and proposed launch sites.

**Table 2.1.2-1: Extended Test Range Target Missile Data**

<b>Name</b>	<b>Length in meters (feet)</b>	<b>Diameter in meters (feet)</b>	<b>Launch weight in kilograms (pounds)</b>
Strategic Target System <sup>1</sup>	10.9 (35.8)	1.4 (4.6)	16,670 (36,750)
Minuteman II Target <sup>2</sup>	18.2 (59.7)	1.7 (5.6)	33,100 (73,000)
Peacekeeper Target <sup>3</sup>	21.8 (71.5)	2.3 (7.5)	87,750 (194,000)
Trident I (C4) Target <sup>4</sup>	10.4 (34.1)	1.8 (5.9)	33,112 (73,000)

<sup>1</sup> U.S. Army Space and Missile Defense Command, 2001b

<sup>2</sup> U.S. Army Space and Strategic Defense Command, 1995

<sup>3</sup> U.S. Department of the Air Force, 2002

<sup>4</sup> U.S. Department of the Navy, 2002b

The target reentry vehicle is the portion of the target missile that is designed to represent threat warheads, or reentry vehicles. The target reentry vehicle would separate from the booster before intercept. Target reentry vehicles typically consist of a steel housing assembly, thermal sensors, guidance and control electronics, radio transmitters and receivers, a power supply (which may include lithium or nickel-cadmium batteries), and a payload section.

### **Strategic Target System**

The primary components of the Strategic Target System vehicle (figure 2.1.2-1) are the first and second stage Polaris A3 boosters, the third stage Orbus-1 booster, and the development payloads. The Strategic Target System vehicle can maneuver once away from the launch pad and over the Pacific Ocean.

### **Target Launch Vehicle (Minuteman II Derivative)**

The Target Launch Vehicle (TLV) (Minuteman II derivative) (figure 2.1.2-1) consists of three solid-propellant rocket engines and a front system. The TLV target would be designed to accommodate a variety of payload sizes, shapes, and interfaces. The TLV target may include a temporary shroud that protects the front section during the early phases of flight.

### **Peacekeeper Target Missile**

The Peacekeeper target missile (figure 2.1.2-1) consists of a modified Peacekeeper missile with three solid propellant rocket motors, a liquid propellant fourth stage, and a reentry system. The reentry system is capable of deploying up to 10 reentry vehicles. Each deployed reentry vehicle follows a ballistic path to its target.

### **Trident Target Missile**

The Trident target (figure 2.1.2-1) consists of an extensively modified Trident three-stage, solid propellant, inertial guided U.S. Navy Fleet Ballistic Missile.

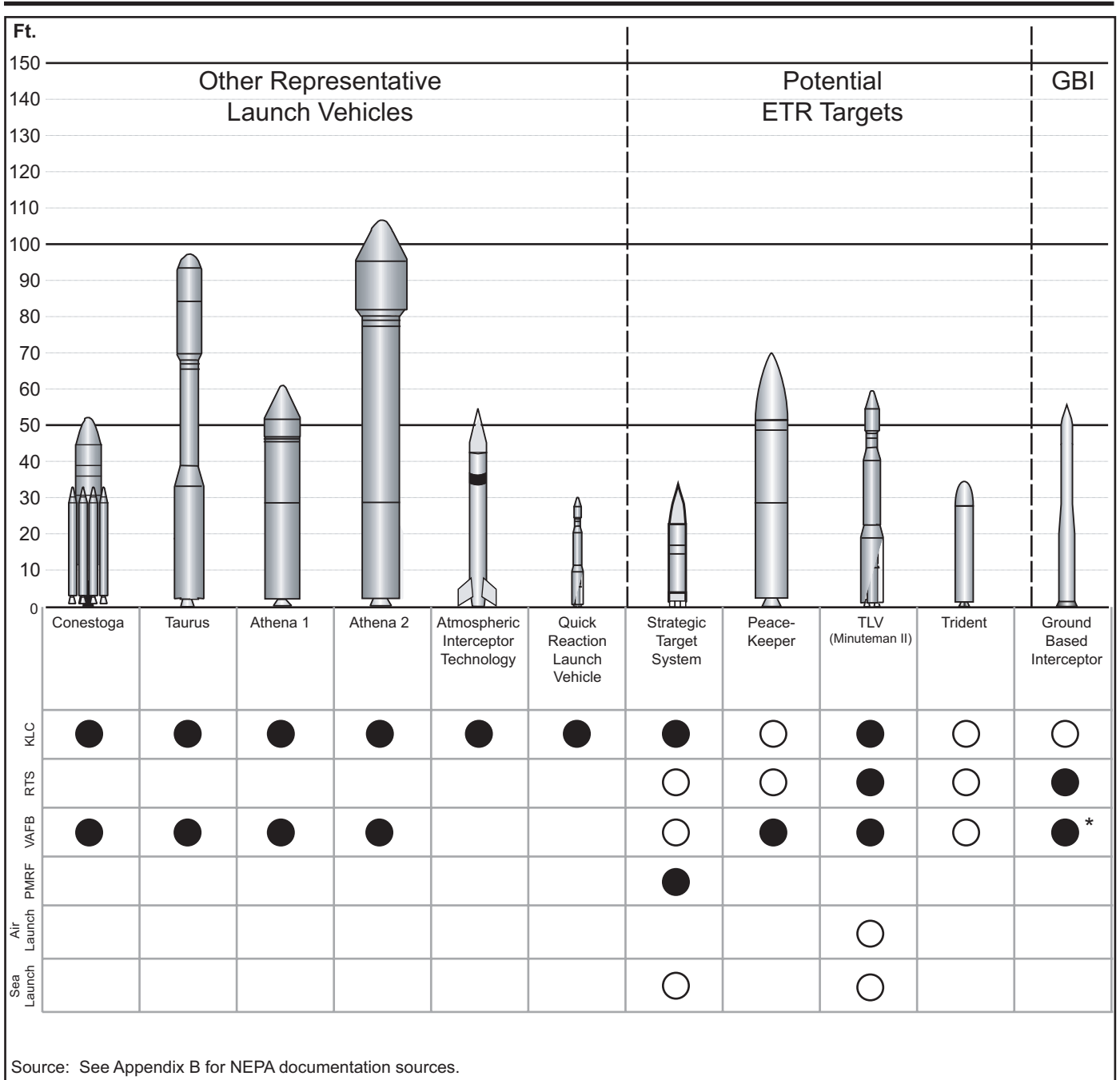

**EXPLANATION**

- Existing NEPA Documentation
- Additional NEPA Documentation Required (ETR EIS)

\* NOTE: Existing GBI launches from Vandenberg Air Force Base are booster verification only, no intercept.

**Representative Launch Vehicles Comparison**

**Figure 2.1.2-1**

### **2.1.2.2 Target Missile Transportation, Handling, Facilities, and Launches**

Missile components would be built in contractor facilities and delivered to the launch site by air, barge, and/or over-the-road truck for system assembly and checkout. Missiles would not be shipped with initiators or other explosive devices. Missiles would be tested at the DoD depot activity or contractor's facility before shipment. All missile components would be packaged in appropriately designed containers, labeled, and handled in accordance with applicable DOT regulations for the transport of hazardous materials. Some missile components may be shipped to an airfield near the launch site and transferred to the launch site by local truck. Trained personnel using only appropriately certified equipment would handle missile components in accordance with approved standard operating procedures.

#### **Ground Launched Target**

Ground launched target missiles would include those listed in table 2.1.2-1. Target missile components and support equipment would be transported by air, barge, and/or over-the-road common carrier trucks from U.S. Government storage depots or contractor facilities to an onsite Missile Assembly Building, where the missile components would be assembled for launch. Applicable safety regulations would be followed in the transport and handling of hazardous materials. An appropriate ESQD would be established and maintained around facilities where ordnance is stored or handled. Target missile launch preparation at ground launch sites may include the following activities:

- Construction and/or modification of facilities and infrastructure to support launch preparation and flight test activities
- Transportation, handling, and storage of target missile system components and assemblies
- Assembly and maintenance of target missile and support equipment
- Checkout and testing of target missile system components and assemblies

Maximum use would be made of existing facilities and infrastructure at ground-based launch sites. Existing facilities would be modified and new facilities constructed only as necessary to support target missile system operations.

Land launches of target missiles would be accomplished from a fixed launch pad or silo. Missiles would be assembled and checked out onsite in a Missile Assembly Building, and erected on a launch stool on the pad or transferred to a launch silo before a scheduled launch. Each facility in which a missile is stored or processed would have an ESQD zone established around it. Before launch, a Launch Hazard Area would be established. The Launch Hazard Area is the area that could be affected by pieces of missile debris should an explosion occur on or just above the launch pad or in the event that the missile's flight must be terminated on the pad or shortly after liftoff. This Launch Hazard Area is cleared of all but mission-essential test personnel during launch operations to ensure personnel are not exposed to missile launch hazards.

The target launch site would be occupied for approximately 2.5 months before a scheduled launch and 2 weeks after a launch. A typical 3-month launch cycle ramp-up would include 25 people during the first month, 55 to 75 people during the second month, and 110 to 150 people during the third month. Dual launch would include 25 people during the first month, 75 to 90

people during the second month, and 150 to 175 people during the third month. After a launch, approximately 50 personnel would immediately depart, and the remaining personnel would depart after launch site refurbishment. Personnel would include contractors, military, and U.S. Government civilians.

The target missile operations at the test site may include missile assembly and checkout, final inspections, testing and checkout of the reentry vehicle, and placement of the target on the launch pad.

The GMD testing would use dedicated utilities for environmental control of the facilities and activities associated with testing. An offsite commercial supplier would supply primary power to the site, but a backup battery system and onsite backup diesel generators would supply emergency power. Generators for various target missile-related facilities would range in output from approximately 75 to 900 kW. Each generator would also have its own dedicated aboveground fuel storage tank. These dedicated tanks would range in capacity from approximately 15,140 to 75,710 liters (4,000 to 20,000 gallons).

### **Air Launch Target**

A typical Air Launch Target missile would include two refurbished Minuteman II motors, a guidance and control unit, and a simulated reentry vehicle. The rocket motors for Air Launch Targets would be shipped to the air launch aircraft location from U.S. Government or contractor facilities by truck and/or air. Other components, such as the target/pallet assembly, would be shipped to the air launch aircraft location from other contractor locations (as applicable). When the missile boosters and other components arrive at the air launch aircraft location, the motor would be transferred to a Missile Assembly Building or a Booster Assembly Building for installation of the Flight Termination System and integration of the other components. The target reentry vehicle would be attached to the booster; then the booster, pallet and sled assembly, and support equipment would be loaded onto the aircraft.

Applicable safety regulations would be followed in the transport and handling of hazardous materials. An appropriate ESQD would be established and maintained around facilities where ordnance is stored or handled.

Approximately 25 to 30 people would be involved in the transportation, handling, and checkout of the missile. The missile components would arrive approximately 3 weeks before scheduled launch. A roller dock assembly with an 11,340-kilogram (25,000-pound) capacity loader would be required to load the target on its pallet. Other handling and transfer equipment would include a crane, forklifts, and a flatbed trailer equipped with transfer rails for the motor.

Selected installations would be able to accommodate the air launch aircraft and support equipment by using existing support facilities and infrastructure. In addition, aircraft flights from these installations would be a routine activity. Therefore, no construction or additional major equipment would be required.

Air Launch Targets would be launched from specifically configured U.S. Air Force cargo aircraft. This launch would involve a target missile on a standard cargo pallet and specialized pallet. Various target missile configurations could be used depending on the range needed for the particular test. The integrated target/pallet assembly would be loaded into the aircraft and flown to a predetermined drop point. The target/pallet assembly would be pulled from the aircraft by parachute and dropped to a level between approximately 6,096 and 7,620 meters (20,000 and 25,000 feet) above mean sea level. The target would separate from the pallet and then descend via parachutes to approximately 4,100 meters (13,450 feet) above mean sea level. At this altitude, the parachutes would release the target, and motor ignition would occur during free-fall. After firing, the boosters would drop into predetermined areas in the Pacific Ocean. The target would then follow its flight path to interception or to splash down within a designated ocean impact area. The target would be fitted with a Flight Termination System to terminate the flight if unsafe conditions develop. Figure 2.1.2-2 depicts a typical aerial target extraction from the aircraft and the launch sequence.

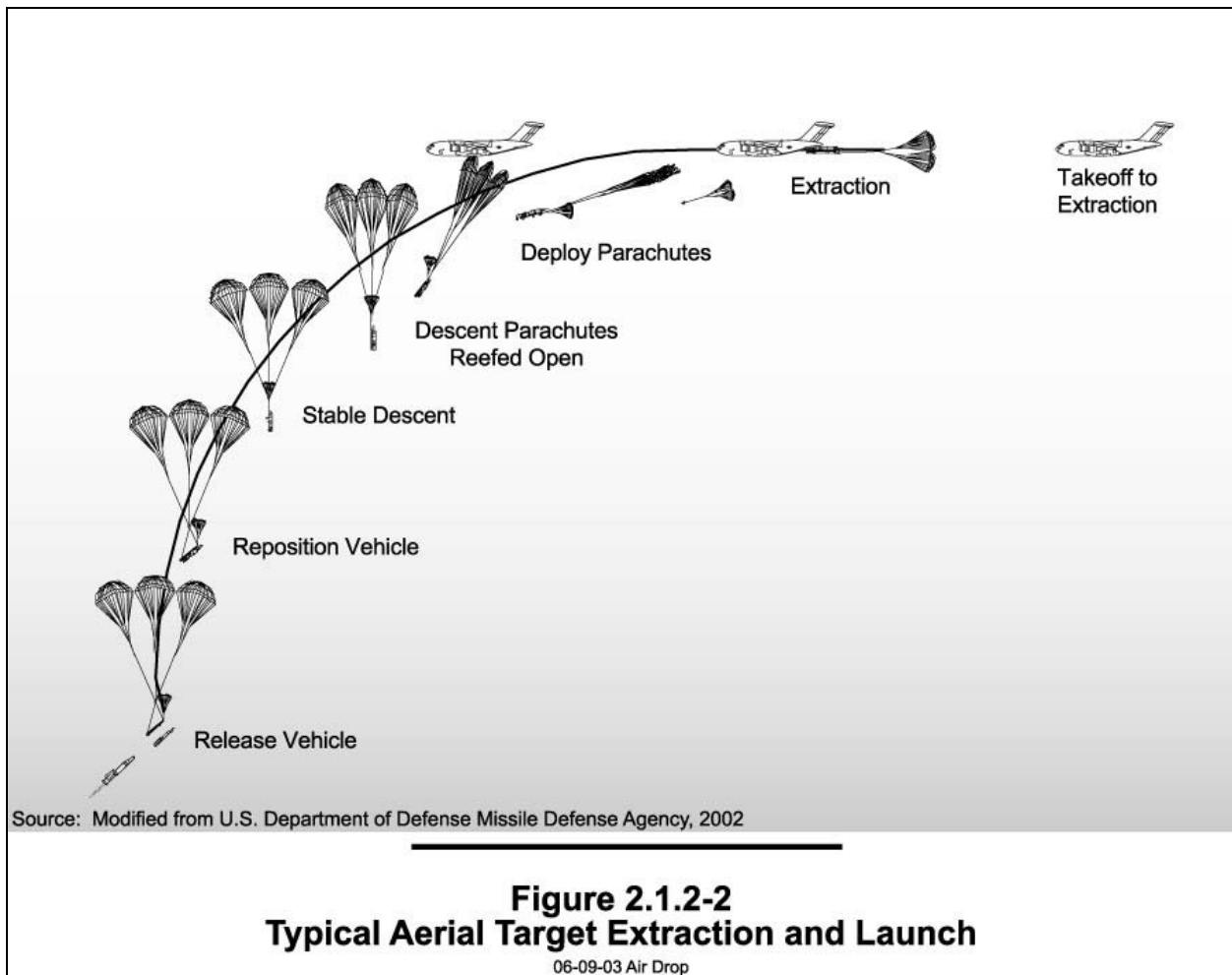



## **Sea Launch Target**

Sea launches of target missiles would be conducted using specially configured missiles and a Mobile Launch Platform (MLP) based at a port with approved explosive handling capabilities. The Sea Launch Target missile would be obtained by modifying an existing Strategic Target System or Minuteman II target missile.

Target missiles and support equipment would be transported from U.S. Government storage depots or contractor facilities in accordance with DOT regulations. They would be placed in secure storage until assembly and launch preparation. Applicable safety regulations would be followed in the transport and handling of hazardous materials. An appropriate ESQD would be established and maintained around facilities where ordnance is stored or handled.

Approximately 50 people would be involved in the transportation, handling, and checkout of the missile. The missile components would arrive approximately 3 weeks before launch.

The MLP would accommodate needed range support systems such as communications relays (command and control), data collectors (telemetry), and tracking systems (infrared or optical). It would also provide a safe shelter for personnel engaged in the mission.

Sea launches of target missiles would be accomplished using the MLP as a launch platform. The MLP would be towed by an ocean tug to appropriate launch locations to support the launch of a target missile.

The MLP (figure 2.1.2-3) is a converted U.S. Navy LPH-10 helicopter carrier, retrofitted to allow for missile storage and launches. It is currently berthed in Concord, California. Target launches from this mobile platform would follow the same procedures as those for fixed ground-based target launches, except that launches would be made from the MLP. The MLP is free-floating and would not be anchored to the ocean floor during launching. The MLP would provide the ability to change launch azimuths and ranges of target missiles.

The MLP possesses large open and enclosed decks, good sea-state stability, onboard living quarters, and a deck-edge elevator. The maximum usable time of the MLP away from port is approximately 21 days, accommodating up to 100 personnel during operations. The MLP would carry fresh water using both existing ship holding tanks and bottled drinking water. Wastewater would be held in existing ship holding tanks when the MLP is within the regulatory distance from shore.

The MLP would be towed from its anchorage to perform launch preparations. The MLP could be positioned in the open ocean area near any alternative test range to provide a launch platform for ground-based target missile launches. To support an intercept, the MLP would be towed to a launch location in the open ocean. Final assembly and checkout of the target missile would be accomplished on the MLP. The MLP would be towed at slow speed during the launch of the target missile.

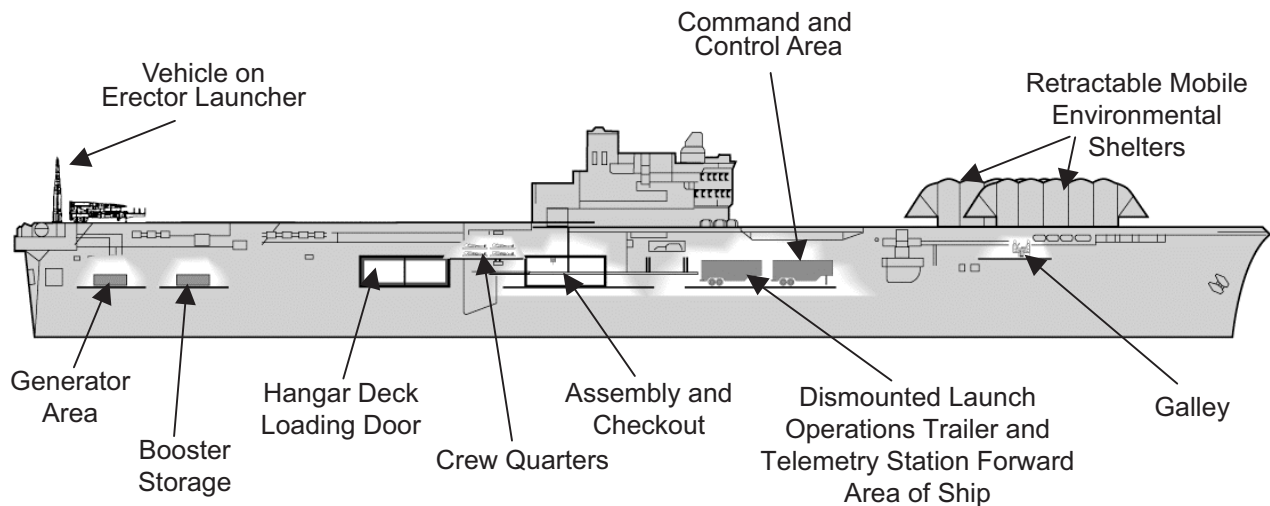

**DIMENSIONS:**  
 LENGTH - 183.6 meters (602 feet)  
 BEAM - 31.7 meters (104 feet)  
 DRAFT - 9.7 meters (32 feet)

**SPEED:**  
 9.3 kilometers per hour  
 (5 knots) (towed)

**DISPLACEMENT:**  
 9,978,980 - 17,077,663 kilograms  
 (11,000 - 18,825 tons)

Source: U.S. Army Space and Missile Defense Command, 2002b (modified).

**Representative Mobile  
 Sea Launch Vessel,  
 Alternative Target  
 Launch Mode**

Not to Scale

**Figure 2.1.2-3**

### **2.1.3 IN-FLIGHT INTERCEPTOR COMMUNICATION SYSTEM DATA TERMINAL OPTIONS**

The IDT provides communication links between the in-flight GBI missile and GMD Fire Control (GFC) components. IDTs are needed in close proximity to the GBI launch sites, and also at remote sites for each GBI flight test. Alternative IDT configurations that would support GBI flight tests may include a combination of fixed (land-based), relocatable (land-based), or mobile IDTs. The IDT is made up of the integration of the compound, facilities, antenna, communications node equipment, long haul communications, and embedded test capability.

#### **2.1.3.1 Fixed In-Flight Interceptor Communication System Data Terminal**

The fixed IDT would be contained in a building that is approximately 30.7 meters by 11.6 meters (101 feet by 38 feet) and would have a 5.5-meter (18-foot) diameter radome mounted on one end of the building (figure 2.1.3-1). The radome, which covers the antenna, would be inflatable. Lightning protection would be provided by lightning masts. Two 9-meter (30-foot) anemometer towers would be located at each site.

A hardened surface of 9.14 meters (30 feet) surrounding the IDT building would permit crane access for installing and, if necessary, replacing the radome or antenna. This area would also provide parking space for two utility vehicles and access for any other equipment that must be brought near the IDT.

An additional modular facility (or facilities) would be temporarily installed within approximately 30 meters (100 feet) of the IDT. This modular facility would be used to provide spare component and repair parts storage and workspace for technicians. There could be an environmentally protected entrance between the IDT and the modular facility. The modular facility would require communications and utility hookups including local commercial power. Interior water tanks and chemical toilets, inside the modular facility, would be frequently serviced and negate the need for water utility pipes and a septic tank system. The estimated size for these facilities would be approximately 186 to 465 square meters (2,000 to 5,000 square feet). An external diesel aboveground fuel tank with a fuel capacity of 3,785 to 5,678 liters (1,000 to 1,500 gallons) would supply fuel to the mission power backup generator, and both would be located near the IDT. This generator would be rated at 300 kW and would be housed in a 3.4- by 1.5-meter (11- by 5-foot) wide enclosure.

A 464.5-square-meter (5,000-square-foot) laydown area that would not interfere with the construction of the IDT buildings would be required. A perimeter fence and a 4.88-meter (16-foot) lockable service gate on the service road would be required for access onto the site. A patrol road is planned around the outside perimeter fence of the IDT compound. Access to the IDT compound would be via an all weather road from the nearest existing service road. There would be a similar road from the gate in the perimeter fence to the IDT building.

##### **2.1.3.1.1 Fixed In-Flight Interceptor Communication System Data Terminal Construction**

The IDT would be built on a concrete foundation designed to withstand local seismic events. An all-weather road to the IDT site would be required. A prepared surface perimeter, at least 4.5 meters (15 feet) wide around the building, would be required for crane access and parking for two utility and maintenance vehicles. Each IDT would result in approximately 3.2 hectares (8.0

**Fixed IDT**

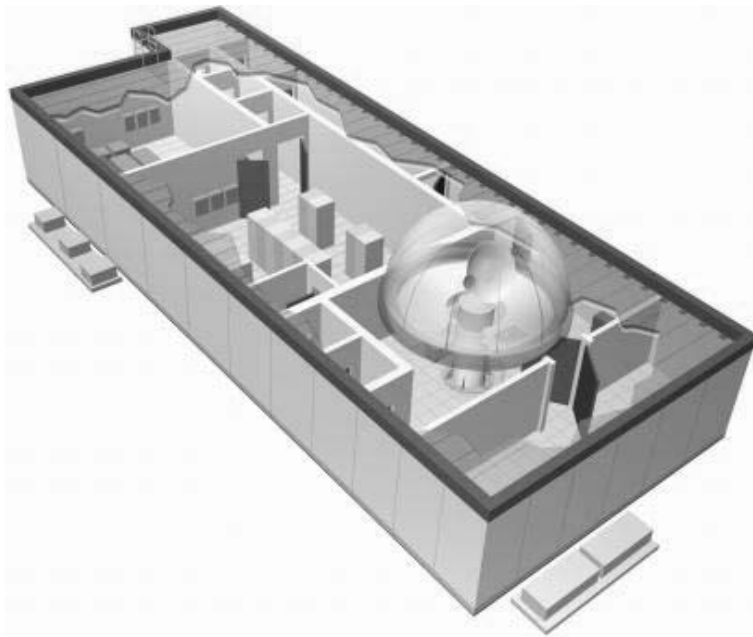

**Mobile IDT**



**EXPLANATION**

IDT = In-flight Interceptor Communication System Data Terminal

**Conceptual Fixed and Mobile IDTs**

**Figure 2.1.3-1**

acres) of disturbed area from construction activities within a fenced area. A perimeter patrol road at some locations would result in a total disturbed area of 5.9 hectares (14.6 acres). Local commercial electrical power would be the primary source of power for the IDTs at all locations, but each would also have onsite backup electrical generation provided by the mission power generator. Three fiber optic administrative telephone circuits would be required for voice communications and alarm monitoring. Power and fiber optic cable would be routed in existing right of ways where practicable. Construction would require approximately 35 personnel for 6 months.

#### **2.1.3.1.2 Fixed In-Flight Interceptor Communication System Data Terminal Operations**

The IDT is a radio transmitter and receiver that would only function during GMD exercises, missions, and test events. It is a Super High Frequency transceiver that would provide communications between the GFC and the in-flight GBI.

The IDT site would normally be unmanned except during acceptance/flight testing, preventative maintenance, corrective maintenance, and future upgrades by up to approximately 10 personnel. Power to an IDT site would be commercial power with backup power supplied by a dedicated generator at each site. Between generator testing and operations during power outages, it is estimated that the onsite backup generator would operate for approximately 200 hours per year.

Other than the diesel fuel and occasional maintenance of the diesel powered electrical generator and associated backup batteries, no hazardous materials or waste (except from chemical toilets) would be stored or generated onsite. One piece of equipment used on the system consists of a Klystron tube, which contains small amounts of beryllium. Should maintenance be required, a new tube would be brought onsite, and the replaced tube would be sent back to the manufacturer for repair.

#### **2.1.3.2 Relocatable In-Flight Interceptor Communication System Data Terminal**

A relocatable type of IDT provides the capability to remove, replace, and relocate the terminal should the need arise. The functions of the fixed and the relocatable IDTs are otherwise identical.

The IDT site would include modular facilities that are similar to the fixed facilities that are described for the fixed IDT in section 2.1.3.1. However the relocatable IDT would have a separate equipment shelter and radome shelter, rather than the combined building at the fixed IDT facility. The modular facility requirements, laydown area, power and manpower requirements, and operations, would be as described in section 2.1.3.1.

There would also be an IDT mounted on the SBX (see section 2.1.4). The SBX IDT would essentially be a modular design with a radome similar to the fixed IDT. Operational requirements would be similar to those of the fixed IDT, including a stable foundation, electricity, communications, utilities, security, lighting, and monitoring systems. Personnel would be transported to and from the platform by boat or helicopter.

### 2.1.3.3 Mobile In-Flight Interceptor Communication System Data Terminal

The mobile IDT (figure 2.1.3-1) would be a vehicle-platform-mounted system. Several vehicles would be required to accommodate the equipment and antennas. The IDT would require substantial redesign to operate as a mobile system. Since the mobile IDT would be an independent standalone system, no site preparation would be required. Separately transported Military Satellite Communication Systems (MILSATCOMs) would provide redundant communication. The primary advantage of the mobile IDT is its ability to move rapidly from site to site.

### 2.1.3.4 In-Flight Interceptor Communication System Data Terminal Security

The IDTs would be designed to meet physical security protection requirements in accordance with DoD 5200.8-R, *Physical Security Program*. They are System Secure Level A assets, and they would typically require protection 24 hours a day. Each IDT would require approximately 3.2 hectares (8.0 acres) of fenced area. Security lighting sufficient for camera observation at each IDT would also be required.

### 2.1.3.5 Ground-Based Midcourse Defense Communications Network

The GMD Communications Network is that portion of the GFC/C component that provides voice and data communications assets consisting of communication network manager resources, transmission equipment and circuits, cryptographic equipment, and local and wide area networks necessary to provide a dedicated, reliable, and secure GMD communication capability.

Components of the GMD Communications Network would be deployed to provide tactical system-like connectivity to all test articles of the ETR. Additional communications capability would also be implemented to provide functional connectivity to components of the IDTs, the GBI and target launch facilities, radars, and the GFC system. Communications would occur via a combination of existing and new communication cables (either fiber optic or copper) and COMSATCOM Earth Terminals.

#### Commercial Satellite Communications

The COMSATCOM Earth Terminal (figure 2.1.3-2) requires a footprint of approximately 0.1 hectare (0.25 acre) to accommodate the Earth Terminal and equipment. Primary power is from a commercial source with



Source: Boeing Corporation, 2001.

**Figure 2.1.3-2**  
**Representative COMSATCOM Earth Terminal**  
06-09-03 COMSATCOM

backup power provided by generator. Communication cable to the launch control complex would be required. Equipment would be housed in a military van, a small building, or an existing adjacent facility if available. Security requirements for fencing include approximately 2.8 hectares (7 acres). The site requirements include a concrete base for the Earth Terminal, an all-weather road to the site, and a prepared surface around the site at least 4.6 meters (15 feet) wide.

### **Communications Cable**

For communication among the components on the same installation, the ETR would maximize use of available communications assets, including cable. If communication cable is not available, new cable would be installed. Installation of new cable would be in existing conduit, if available. If not, new conduit would be constructed along rights-of-way. Where necessary, new conduit would require a route approximately 1 meter (3 feet) wide, buried to a depth of approximately 1 meter (3 feet) from the surface. A manhole and cover would be located approximately every 200 meters (600 feet) to allow access to the cables for maintenance and for future cable installations.

#### **2.1.4 SEA-BASED TEST X-BAND RADAR**

An SBX would support GMD integrated flight testing. It would exercise all midcourse sensor functions including weapon task plans, in-flight target updates, target object maps, and kill assessments. The SBX would support most ETR test scenarios, with additional support provided by the existing ground-based radar prototype (GBR-P) located at RTS at USAKA.

The SBX is made up of a seagoing platform on which an XBR has been mounted. This section describes the platform, the XBR, and the modifications required to the platform for the XBR to function correctly.

##### **2.1.4.1 Sea-Based Platform**

The sea-based platform is an existing commercial platform manufactured by Moss Maritime of Oslo, Norway. The platform is a column-stabilized semi-submersible platform, with two pontoons and six stabilizing columns supporting the upper hull. The bare platform has a completely flat top deck on top of an enclosed double bottom structure. The structure has sufficient strength to support a deck load of 18,144 metric tons (20,000 tons). Table 2.1.4-1 provides the dimensions of the platform.

The sea-based platform is semi-submersible, meaning that it would have large ballast tanks that are evacuated to reduce draft for transit or portside use. When in position for testing, the tanks would be flooded, which both increases the displacement and lowers the center of mass, significantly reducing vulnerability to surface weather. Semi-submersibles can be anchored in up to 1,500 meters (5,000 feet) of water. Figure 2.1.4-1 shows an artist's concept of the XBR and sea-based platform.

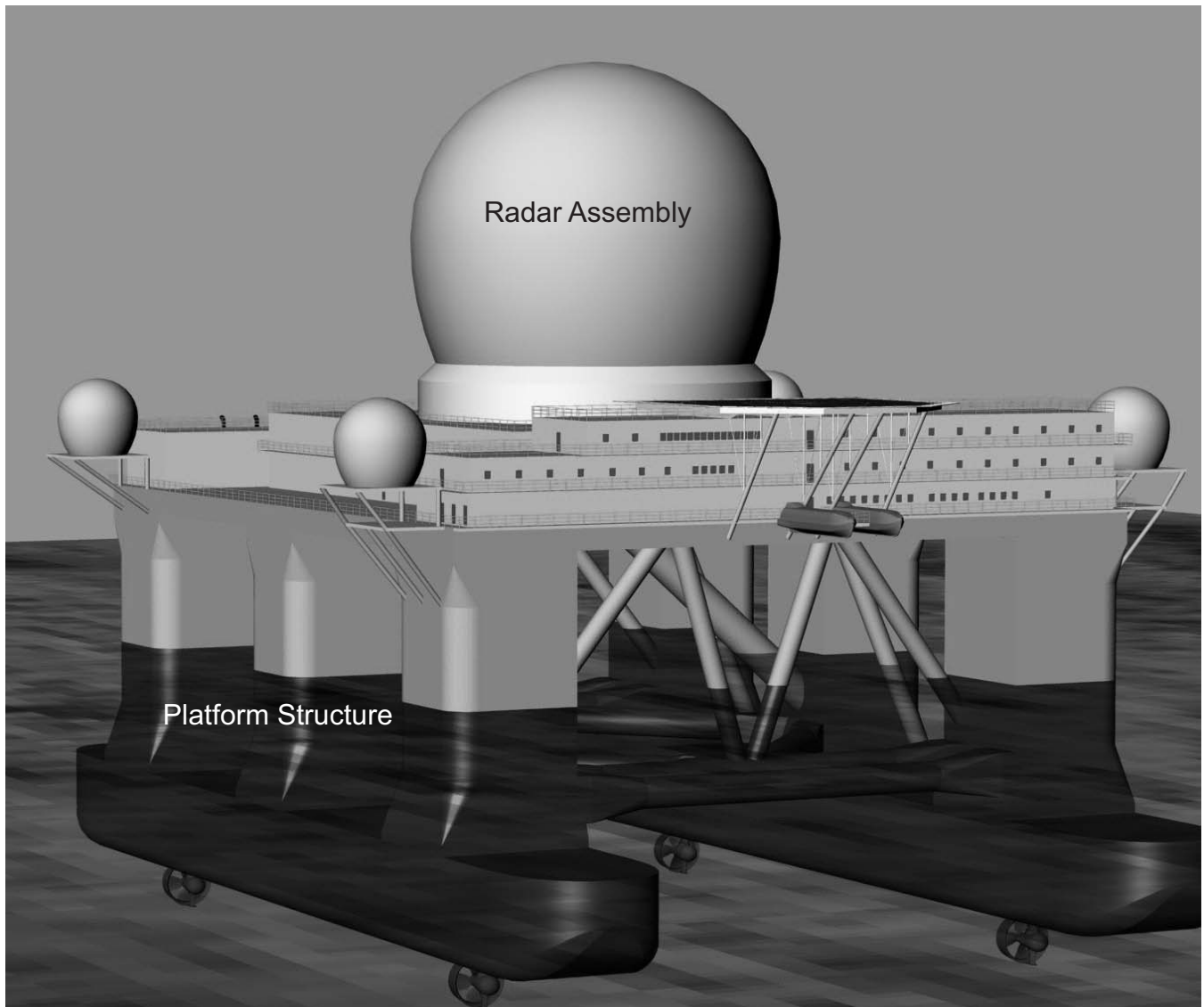

Source: Boeing Corporation, 2002a (modified).

## Conceptual Sea-Based Test X-Band Radar

Not to Scale

**Figure 2.1.4-1**



**Table 2.1.4-1: Platform Dimensions**

<b>Platform Characteristic</b>	<b>Dimensions</b>
Upper Hull	
Length of deck	82.85 meters (272 feet)
Breadth of deck	70.43 meters (231 feet)
Height to upper deck	40.65 meters (133 feet)
Draft during operation (after thrusters are installed)	26.0/28.0 meters (85.3/91.8 feet)
Draft during transit (after thrusters are installed)	15.24 meters (50.0 feet)
Pontoons	
Length	118.56 meters (389 feet)
Breadth	14.45 meters (47 feet)
Depth	10.15 meters (33.3 feet)
Pontoon spacing	58.00 meters (190 feet)
Displacement during operation	45,668 metric tons (50,340 tons)
Displacement in transit	29,756 metric tons (32,800 tons)

#### **2.1.4.2 X-Band Radar**

The XBR would be a multifunction radar that would perform tracking, discrimination, and kill assessments of overflying target missiles. The XBR would use high frequency and advanced radar signal processing technology to improve target resolution, which permits the radar to discriminate against various threats. The XBR would provide data from the mid-phase of a target missile's trajectory and real-time in-flight tracking data to the GFC. The XBR would be mounted on a 27-meter (90-foot) diameter antenna mount track support cylinder housed in a 31-meter (103-foot) base diameter radome. Total height of the SBX above the water line including the XBR radome would be approximately 76.3 meters (250 feet) at transit draft. The XBR would have either a 65 percent populated array (approximately 39,000 elements) or a fully populated array (approximately 60,000 elements) to support the planned testing.

The XBR transmit/receive radiofrequency (RF) emission pattern would be a narrow beam (several meters diameter at 25 kilometers [15.5 miles]) with most of the energy contained within the main beam. Each main beam would consist of a series of electromagnetic pulses. The main beam would be able to provide near hemispherical coverage; i.e., 360 degrees in azimuth. At no time would the main beam be directed at the ground or water surface. Lesser amounts of energy would be emitted in the form of grating and side lobes in the area around the main beam. The main beam would have a lower limit of 10 degrees above horizontal for calibration and maintenance testing while at the Primary Support Base. The side lobes that reach the ground would be far removed from the main beam and would not contain sufficient energy to present any type of RF emission hazard.

Potential issues associated with electromagnetic radiation (EMR) are related to aircraft, electroexplosive devices (EEDs), communication and electronics equipment, and personnel safety. Figure 2.1.4-2 shows the SBX Radar Potential EMR Interference Areas, and table 2.1.4-2 lists the EMR potential interference distances.

### Fully Populated SBX Radar Potential Interference

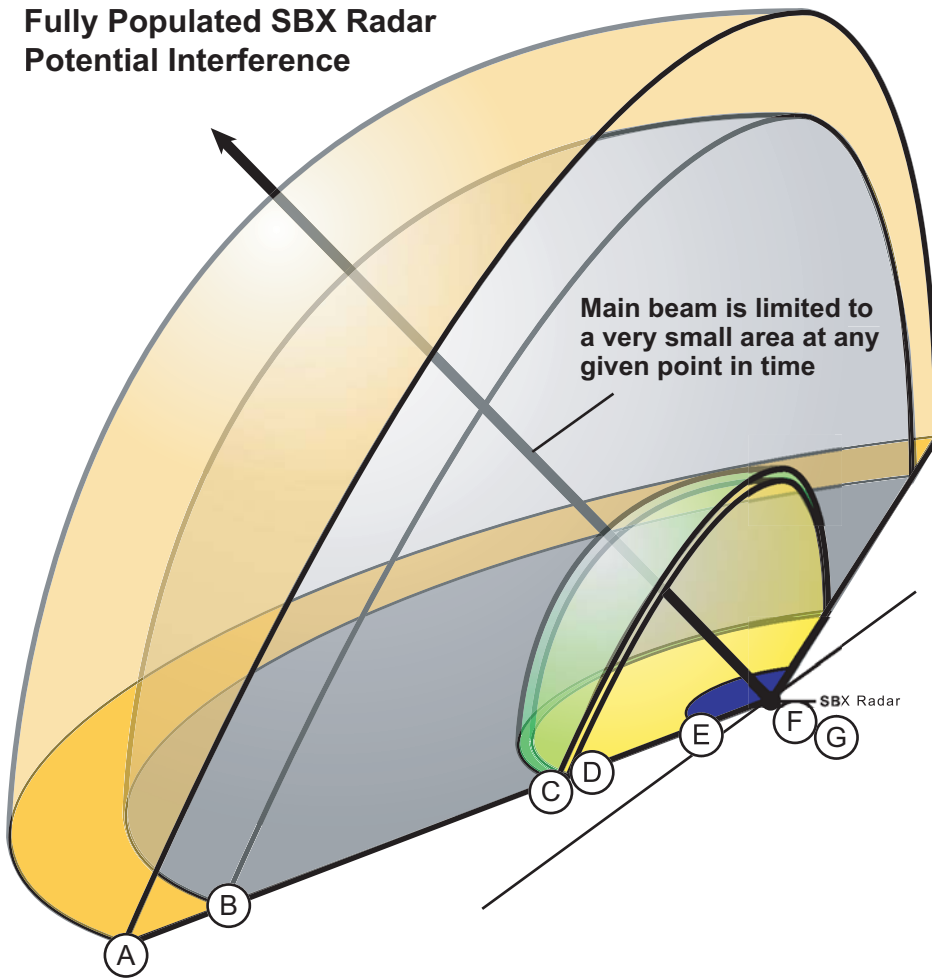

### 65% Populated SBX Radar Potential Interference

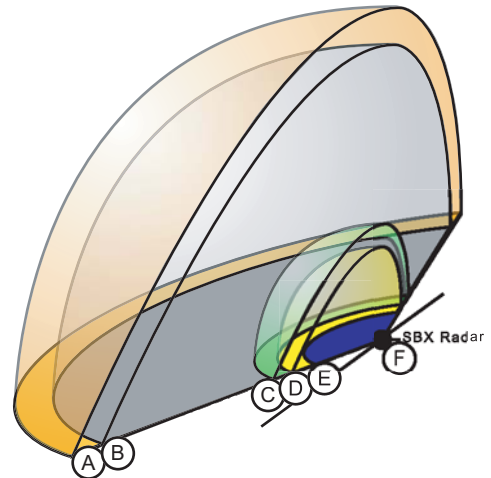

**Note:** Only a portion of the potential interference distances are shown. The potential interference could be 360° around the SBX radar.

Source: Sages, 2003

#### EXPLANATION

Type of Interference	Fully Populated	65% Populated
A Commercial Communication/Electronics (Orange)	22.4 kilometers	15.4 kilometers
B Commercial Aircraft (Grey)	19 kilometers	12.1 kilometers
C EEDs in Presence and Shipping Phase (Air)(Green)	7.5 kilometers	4.8 kilometers
D Military Communication/Electronics (Yellow)	7.1 kilometers	3.5 kilometers
E EEDs in Loading and Handling Phase (Blue)	2.3 kilometers	1.6 kilometers
F EEDs in Presence and Shipping Phase (Ground)	< 10 meters	< 10 meters
G Personnel (with software controls)	0 meters	0 meters

**Note:** Vertical dimensions are consistent with horizontal dimensions

Not to Scale

### SBX Radar Potential Interference

Figure 2.1.4-2

**Table 2.1.4-2: Electromagnetic Radiation Potential Interference Distances for SBX**

	65 Percent Populated	Fully Populated
	kilometers (miles)	kilometers (miles)
Main beam (average field intensity) on an aircraft (air)	12.1 (7.5)	19 (11.8)
Main beam on an EED presence/shipping (ground and air) such as a missile mounted on an aircraft wing or an EED in a shipping container	4.8 (3.0)	7.5 (4.6)
Grating lobe on an EED handling (ground) where an EED is in an exposed position	1.6 (1.0)	2.3 (1.4)
Grating lobe on an EED presence/shipping (ground and air) such as a vehicle airbag or an EED in a shipping container	<10 meters (<33 feet)	<10 meters (<33 feet)
Military communications/electronics	3.5 (2.2)	7.1 (4.4)
Commercial communications/electronics	15.4 (9.6)	22.4 (13.9)
Grating or side lobe personnel hazard (exceeds Permissible Exposure Limit within)	85 meters <sup>1</sup> (279 feet <sup>1</sup> ) 0 meters <sup>2</sup> (0 feet <sup>2</sup> )	150 meters <sup>1</sup> (493 feet <sup>1</sup> ) (0 meters) <sup>2</sup> (0 feet <sup>2</sup> )

<sup>1</sup> Personnel Hazard distance worst case—without software controls

<sup>2</sup> Personnel Hazard distance with software controls

EED = Electroexplosive Device—a device in which electrical energy is used to initiate an enclosed explosive, propellant, or pyrotechnic material

It should be noted that at the Primary Support Base, even at the lower operating limit of 10 degrees, the altitude of the main beam would be well above the surrounding area as shown in table 2.1.4-3.

To ensure public safety from potential EMR effects, an EMR/electromagnetic interference (EMI) study is currently underway for each potential operating area. This study would then support an application for spectrum certification and frequency allocation.

**Table 2.1.4-3: SBX Main Beam Altitude at 10 Degree Elevation Operating Level**

Distance From SBX kilometers (miles)	Altitude Above SBX meters (feet)
0.4 (0.25)	132 (293)
1.6 (1.0)	345 (1,131)
4.8 (3.0)	912 (2,993)
8.0 (5.0)	1,480 (4,855)
11.3 (7.0)	2,047 (6,717)
14.5 (9.0)	2,615 (8,579)
19.3 (12.0)	3,466 (11,372)
22.5 (14)	4,034 (13,234)

Civilian aircraft must be hardened or protected from EMR levels up to 3,000 volts per meter (V/m) (peak power) and 300 V/m (average power) as mandated by the FAA by Notice 8110.71, *Guidelines for the Certification of Aircraft Flying through High Intensity Radiated Field Environments*. The SBX would not exceed the 3,000 V/m peak power threshold. The average power threshold is based upon reducing the time of exposure of aircraft avionics (electronic equipment) to High Intensity Radiated Fields in order to preclude shortening the life of the aircraft avionics. Therefore, the concern is not interference but is a reduction in the life of the aircraft avionics.

For some operating areas, following coordination with the FAA, a high-energy radiation area notice may be requested from the FAA to be published on aeronautical flight information charts. As shown in table 2.1.4-2, based on modeling of the 65 percent and fully populated XBR, the FAA standard for average radiation exposure to aircraft could be exceeded out to a distance of 12.1 kilometers (7.5 miles) from the 65 percent populated radar and out to 19 kilometers (11.8 miles) from the fully populated radar. The potential high-energy radiation area for the XBR would therefore extend out to 12.1 kilometers (7.5 miles) and 19 kilometers (11.8 miles) for the 65 percent and fully populated radar. However, based on the spectrum certification and frequency allocation process, the high energy radiation area would be modified to fit existing airport and airspace requirements. Before operation of the XBR during individual tests, the FAA would provide notice to affected airports and aircraft through a Notice to Airmen (NOTAM).

EEDs are used for a variety of applications from the release of ordnance from the wing of an aircraft, for automatic fire extinguishers on aircraft, for pilot ejection seats, and even for the release of air bags on automobiles. An electrical current sufficient to initiate the EED can be induced by exposure of the device to an electromagnetic field. Thus, high levels of EMR can inadvertently initiate the device. Energy from EMR may also cause the EED to become inactive (a phenomenon known as dudding).

EEDs on aircraft in flight could be illuminated by the mainbeam of the SBX. As shown in table 2.1.4-2, based on modeling of the 65 percent and fully populated XBR, EEDs on aircraft in flight could be illuminated by the mainbeam of the SBX out to a distance of 4.8 kilometers (3 miles) from the 65 percent populated radar and out to 7.5 kilometers (4.6 miles) from the fully populated radar. Software controls and coordination with military and commercial aircraft controllers would eliminate this potential hazard. The power coming off of the grating lobes and side lobes of the SBX could illuminate EEDs on the ground. However, the potential radiation hazard would be limited to less than 10 meters (33 feet) in front of the radar, which includes a portion of the main deck of the SBX. Therefore EEDs on the ground, including those associated with airbags in vehicles, would not be affected.

The proposed SBX operates within the 8,000–12,000 MHz frequency band, commonly referred to as the X-band. RF interference is most likely to occur when two pieces of communications-electronics equipment are operated within the same frequency band. Therefore, equipment whose frequencies fall within the X-band is most likely to be affected by the SBX. Some examples of X-band communications-electronics equipment include airborne weather radars, fire control radars, and bomb/navigation radars. Garage door openers are well below this frequency and would not be affected. Interference is also possible to systems that operate in harmonically-related frequency bands. Harmonic frequencies include those frequencies that are integer multiples of the operating frequencies. Systems that operate in harmonically-related

frequency bands include airport surface detection equipment and broadcasting satellite service. Personal home satellite systems would not be affected.

Systems that operate outside of X-band and the harmonically-related frequency bands could be subject to interference due to high power effects from the SBX. High power effects typically occur in receivers that are located close to high power transmitters. The accepted levels for high power effects are 1 mW/cm<sup>2</sup> for military equipment and 0.1 mW/cm<sup>2</sup> for civilian equipment. At power levels below these thresholds, it can be reasonably assumed that high power effects are not likely to occur. At power levels above these thresholds, it cannot be stated with certainty that high power effects would occur, only that they are possible. Under proposed SBX operating conditions, full power operation would involve tracking objects in space with the beam pointed up and constantly moving. The beam would not remain stationary for any appreciable period of time; thus, the odds of interference from high power effects with any electronic equipment on the ground would be slight, 1/1000000 or 0.0001 percent of the time (roughly 1/10 of a second per day). The effects would not damage any electronic equipment and would last for less than a second, should this occur.

Under proposed SBX operating conditions, full power operation would involve tracking objects in space with the beam pointed up and constantly moving. The beam would not remain stationary for any period of time, and software controls would not allow a full power beam to come in contact with any personnel, on the platform or on land. Two separate, redundant computer systems would monitor all emission energy levels at locations around the radar to assure safe exposure levels are maintained. Similar software controls have been effectively used on the large X-band radar currently operating at Kwajalein Island in the Republic of the Marshall Islands.

#### **2.1.4.3 Assembly and Retrofit Operations**

The sea-based platform would be retrofitted at an existing shipyard on the U.S. Gulf Coast. It is possible that some retrofit operations could be completed at a shipyard on the U.S. west coast following transit from the Gulf Coast shipyard. The platform would initially be moored at a shipyard in Brownsville, Texas. After arrival at the shipyard, the platform would be outfitted with a variety of subelements that would allow it to function as a self-propelled seagoing platform. These modifications would include installation of the thrusters and preparation for the radar assembly installation. Upon completion of the ship modifications, the vessel would sail to Corpus Christi, Texas, for installation of the radar assembly. The subelements are divided between the facilities requirements and the XBR payload. Table 2.1.4-4 lists the various subelements.

The Radar Support Structure (RSS) and Drive Platform Control System would be assembled at the shipyard with its materials being transported either by truck or barge. The RSS and the Drive Platform Control System would be fully assembled on a concrete slab (existing or new depending on the shipyard selected). They would then be barged to the platform and lifted into place and installed on the top deck of the platform. At the fabrication site, low power calibration of single elements and subarrays plus low power radiation for systems checkout before integration on the platform would be performed. Full power emissions are defined as emissions from all elements in the array and occur during all other calibration, tracking, and mission tasks.

**Table 2.1.4-4: Sea-Based Platform Subelements**

<b>X-Band Radar Payload</b>	<b>Facilities Requirements</b>
Antenna Mount	Semi-submersible Platform
Radome	Radar Structure Support Module
Drive Platform Control System	Thermal Control Subsystem
Antenna Equipment	Power Control Subsystem
Receiver/Exciter	Propulsion Subsystem
Beam Steering Generator	Navigational Subsystem
Signal Data Processing Equipment	Crew Accommodations Modules
Auxiliary Equipment	Operations Control Center
Liquid Conditioning and Circulating System	Radar Maintenance
System Interconnects	Office Space
In Flight Interceptor Communication System	Spares Storage
Communication Subsystem	
Dual Commercial Links	
Commercial Satellite Communications	

A full navigation suite would be provided with a high degree of automation to minimize the size of required marine crew. The SBX platform would be self-propelled by four steerable 3.4-megawatt (MW) electrically driven thrusters, which extend below the bottom surface of the platform's pontoons. While in open water, two thrusters would effectively propel and maneuver the SBX without assistance. In port, the SBX would be towed and assisted with at least two tugboats.

The SBX platform thrusters would be a retractable type. While the thrusters are extended, the draft of the SBX platform would be approximately 15.2 meters (50 feet). The retractable thrusters can be lifted into the pontoons to reduce the draft of the platform to approximately 10.7 meters (35 feet), allowing it to enter deep ports.

Crew member accommodations would be for 50 people, which currently include approximately 20 marine crew members and 30 GMD mission support personnel. In addition, there would be sufficient berthing, accommodations, and lifesaving equipment to support an additional 50 people onboard on a temporary basis to support testing.

Communication systems and an IDT would be mounted and positioned on opposite corners of the platform deck below the minimum depression of the radar beam. The SBX would use a single link, dual redundant IDT with two antennas. The two sets offer redundancy and avoid obscuration by the radar. There would also be two COMSATCOM terminals with two antennas each for a total of six antennas on the SBX.

#### **2.1.4.4 Integrated Platform Testing in the Gulf of Mexico**

The platform subsystem tests would be conducted in the shipyard. These tests would evaluate the performance of individual subsystems.

The initial sea trials would take place in the Gulf of Mexico. These tests are designed to ensure maneuverability and control of the vessel. Since these tests may run in parallel with the payload installation and checkout tests, mass simulators may be used to represent uninstalled portions during the stability and control evaluations. The emphasis would be on identifying and correcting problem operating conditions, such as vibrations that result from the installation of diesel and electric generators above the main deck or the vessel's electric thrusters.

During the integrated platform testing, full power radiation for satellite and calibration device tracking would be performed. Electrical power requirements for the SBX platform and its various payloads would be approximately 21.8 MW. This would be supplied by eight 3.64-MW generators. Six generators of the eight would be used at any given time, and two would remain in reserve or as backup in case of failures or routine maintenance. Two of the four 3.4-MW thrusters would typically propel the SBX and consume 7 MW, with approximately 14.8 MW available for ship-board operations and powering the radar. The SBX would have a fuel capacity of approximately 3,100,000 liters (818,000 gallons). Approximate fuel consumption for transit and radar operation would be 54,800 liters (14,500 gallons) per day. Fuel consumption while hooked up to a primary support base pier would be 6,130 liters (1,620 gallons) per day.

#### **2.1.4.5 Transportation of Sea-Based Test X-Band Radar from Assembly Point to Primary Support Base/Operations Area**

The SBX would be self-powered, with a nominal cruising speed of approximately 15 kilometers per hour (8 knots) with two 3.4-MW thrusters. Due to the large "sail area" created by the XBR radome, actual cruising speeds would be affected by prevailing wind conditions. A 7-month test period would begin with the trip around South America to the Pacific Ocean. The Panama Canal cannot accommodate the width of the completed SBX platform. The transit time would create opportunities for testing as the vessel travels from the Gulf of Mexico to the Pacific test area.

Periodic test emissions for satellite and calibration device tracking would occur. In transit, the SBX would stop at predetermined locations, the FAA would provide notice to affected airports and aircraft through a NOTAM, marine traffic would be notified through a Notice to Mariners (NOTMAR), and then the SBX would conduct the test.

One or more escort ships may accompany the SBX during transit around South America and during testing.

#### **2.1.4.6 SBX Basing Activities and Primary Support Base Alternatives**

In between GMD test missions the SBX would return to a Primary Support Base (PSB) for crew rotations, resupply, and maintenance activities. The SBX would have a 10.7-meter (35-foot) draft. Because most harbors do not have the necessary depth to accommodate the SBX, it would not enter most port facilities after it leaves its assembly point in the Gulf of Mexico. If the SBX arrives at a location that cannot accommodate its deep draft, the vessel would moor or

anchor offshore. Food, supplies, repair parts, and fuel would be delivered by supply ship. The distance that the SBX would remain offshore would be determined by several factors including water depth, transport capabilities of the support location, and radar testing requirements. Where port facilities have sufficient depth, the SBX would enter the port and utilize existing dockside facilities.

Although specific security guidelines have not been adopted for the SBX, it would likely utilize existing security zones, if they exist, at the PSB. If a security zone does not exist, then the SBX would likely utilize the same protection zone that applies to U.S. Navy vessels that are underway. Established by U.S. Coast Guard rule, this would include a 91.4-meter (100-yard) security exclusion zone around the vessel and a slow speed zone between 91.4 and 457 meters (100 and 500 yards) from the vessel. A security zone like this would likely be in effect as the SBX transits or when it is moored.

It is expected that the SBX would continue to operate the XBR while near or at the PSB. The operation would include system testing, calibration, and tracking of satellites. Radar emissions would occur in 15- to 20-minute periods totaling approximately 1 hour per day.

If existing facilities are not available or adequate at the PSB, some new storage and administration facilities would be constructed. If existing facilities are used, security upgrades, environmental controls for storage areas, fueling capability, ship gases handling facilities, computer networks, phone systems, and hazardous material storage and disposal may be added. Ongoing logistics and support operations such as resupply, fueling and maintenance, and crew/operator training would also occur at the PSB. Potential PSBs include Pearl Harbor, Hawaii; RTS; NBVC Port Hueneme, California; Naval Station Everett, Washington; Adak, Alaska; and Valdez, Alaska. In addition to supporting the ETR test activities, the SBX could also be used to support initial defensive operations capabilities being developed at Fort Greely, Alaska, and Vandenberg AFB, California. The activities described above for the SBX at the PSB would be identical for an SBX supporting initial defensive operations capability. The potential PSBs that would support initial defensive operations are the same as those listed above for the ETR. The evaluation of these PSBs to determine their capability to support initial defensive operations would include additional evaluative criteria. Section 2.4.4 describes the SBX PSB siting process and alternative locations considered.

#### **2.1.4.7 SBX Test Activities**



Numerous test flight scenarios would be conducted during the GMD ETR testing. Three SBX performance regions have been established to accomplish effective radar coverage for the test flights. Figure 2.1.4-3 shows the three performance regions that would be used. The SBX would operate within the approximate confines of one of the three performance regions based on the needs of the particular flight test scenario.

Approximately 10 to 12 days before a GMD test mission, the SBX would leave the PSB to travel to the designated performance region. During transit time, on-station time, and the return trip, the SBX would have certain preparation and mission activities. On-station GMD mission activities would include providing data from earlier phases of a target missile's trajectory and real-time in-flight target tracking data to the GFC. During test activities the SBX would use its

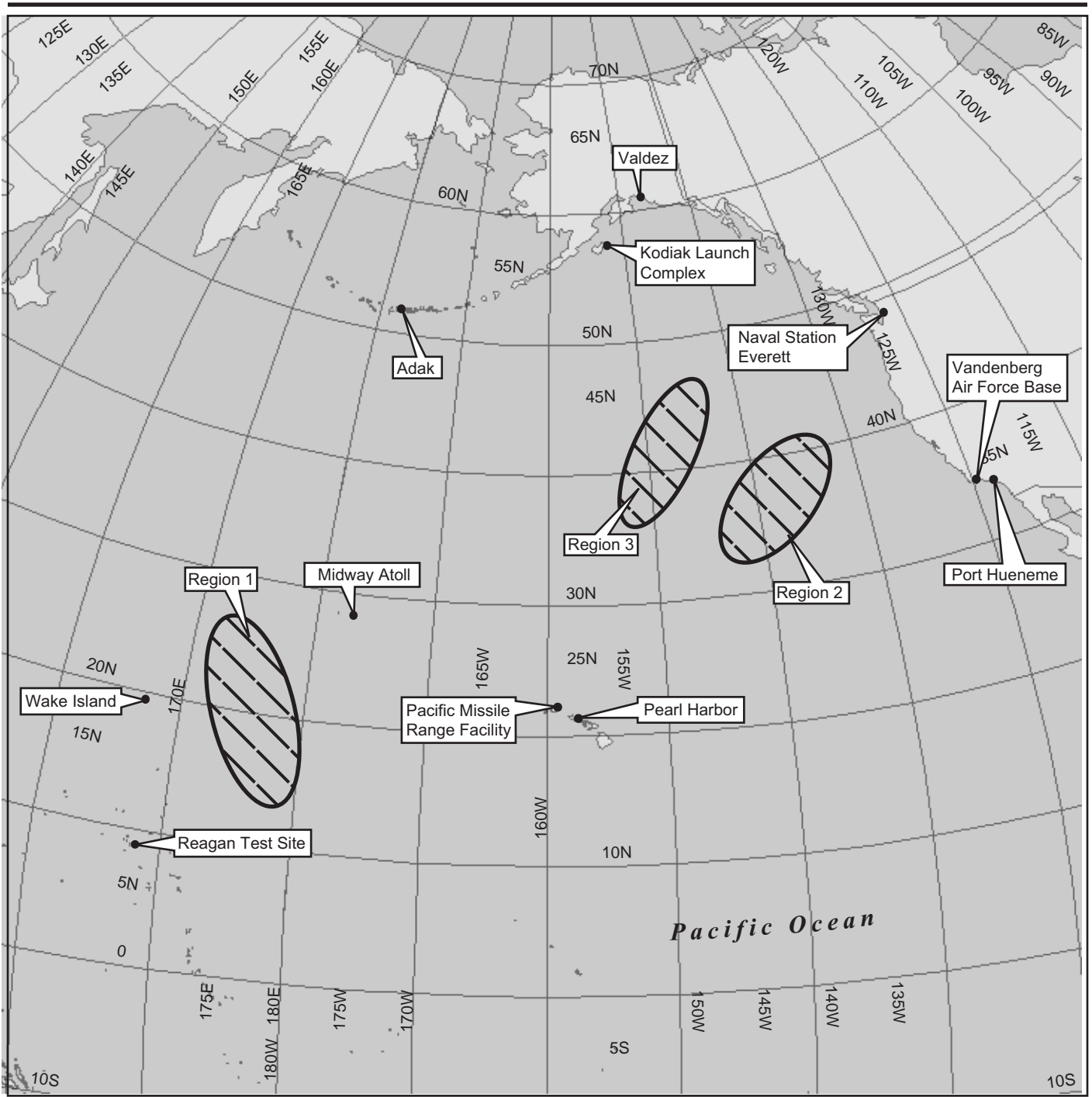



**EXPLANATION**

-  Performance Regions
-  Ground-based Midcourse Defense Potential Sites

**SBX Performance Regions**

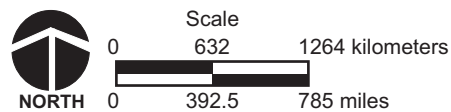

Pacific Ocean

**Figure 2.1.4-3**

multi-directional thrusters to remain in one location or travel at extremely slow speed while the radar is operating. Table 2.1.4-5 shows those pre-mission, mission, and post-mission activities that the SBX would perform. During test activities the SBX would likely utilize the same protection zone that applies to U.S. Navy vessels that are underway. This would include a 91.4-meter (100-yard) security exclusion zone around the vessel and a slow speed zone between 91.4 and 457 meters (100 and 500 yards) from the vessel.

**Table 2.1.4-5: Sea-Based Test X-Band Radar Mission Activities**

Status	Duration	Location	Activities
Transit Time (Pre-Mission Status)	10 to 12 days	■ In Transit	<ul style="list-style-type: none"> <li>■ Pre-Mission Support</li> <li>■ Pre-Operational Checks</li> <li>■ Marine/Radar Crew Training</li> <li>■ Maintenance</li> <li>■ Sustainment</li> </ul>
On-Station Time (Mission Status)	10 to 14 days	■ Afloat/On-Station	<ul style="list-style-type: none"> <li>■ Marine/Radar Crew Rehearsals/Training</li> <li>■ Interceptor Flight Test Mission Support</li> <li>■ Maintenance</li> <li>■ Sustainment</li> </ul>
Transit Time (Post-Mission Status)	10 to 12 days	■ In Transit	<ul style="list-style-type: none"> <li>■ In-Transit</li> <li>■ Data Reduction</li> <li>■ Maintenance</li> <li>■ Resupply</li> <li>■ Training</li> <li>■ Mission Preparation</li> <li>■ Stand Down/Standby</li> </ul>

Daily activities for the SBX would vary according to what phase of integrated testing the radar is in. Mission preparation activities would consist of satellite and sphere tracking, simulation runs, and operations and maintenance. The total amount of radar RF radiation per week would be approximately 5 to 6 hours. During actual GMD mission activities, the actual total duration of RF radiation would decrease to 3 to 4 hours per week. Table 2.1.4-6 shows the specific types of radar testing that would occur during all phases of SBX activities.

The SBX would operate in a manner similar to other large ocean-going vessels and could stop at ports other than the PSB to resupply. The SBX would utilize dockside facilities if available or anchor/maintain position offshore during the resupply activities.

**Table 2.1.4-6: Sea-Based Test X-Band Radar Test Activities**

<b>Location</b>	<b>Activity</b>
Fabrication at Gulf Coast Shipyard	Single Element Emission <ul style="list-style-type: none"> <li>■ Calibration</li> </ul>
Sea Trials, Gulf of Mexico	Full Array Emission <ul style="list-style-type: none"> <li>■ Short Duration Tests</li> <li>■ Satellite Tracks</li> <li>■ Calibration Tracks</li> </ul>
In-Transit—Gulf of Mexico, Atlantic Ocean, Pacific Ocean	Full Array Emission <ul style="list-style-type: none"> <li>■ Daily Testing</li> <li>■ Satellite Tracks</li> <li>■ Calibration Tracks</li> </ul>
Potential Final Fabrication at West Coast Shipyard	Single Element Emission <ul style="list-style-type: none"> <li>■ Calibration</li> </ul>
Primary Support Base	Full Array Emission <ul style="list-style-type: none"> <li>■ Periodic Short Duration Tests</li> <li>■ Satellite Tracks</li> <li>■ Calibration Tracks</li> </ul>
In-Transit to Test Site	Full Array Emission <ul style="list-style-type: none"> <li>■ Daily Testing</li> <li>■ Satellite Tracks</li> <li>■ Calibration Tracks</li> </ul>
On-Station at Test Site	Full Array Emission <ul style="list-style-type: none"> <li>■ Periodic Short Duration Tests</li> <li>■ Satellite Tracks</li> <li>■ Calibration Tracks</li> <li>■ Mission Support</li> </ul>
In-Transit from Test Site	Full Array Emission <ul style="list-style-type: none"> <li>■ Daily Testing</li> <li>■ Satellite Tracks</li> <li>■ Calibration Tracks</li> </ul>

### **2.1.5 TEST RANGE SENSORS AND SUPPORT INSTRUMENTATION**

Sensor systems are used to acquire, record, and process data on targets and interceptor missiles to detect and track targets, direct defensive missiles, and assess whether a target has been destroyed. Sensor systems also include signal-processing components.

The signal-processing components receive the raw data collected by the sensor elements and process it, using computer hardware and software, into usable information such as target location, velocity, and attitude. These and other relevant characteristics can then be used to plan and control intercept engagements.

Sensor systems associated with interceptor missiles that may be used include existing ground-based sensors and newly developed or modified sensor systems. Sensors planned for use would be fixed or portable units. These units are routinely used to support missile flight tests. Potentially, other airborne sensors, ship-based sensors, and space-based sensors would also be used for surveillance and tracking support as part of these proposed GMD missile tests.

Instrumentation associated with the launch of a target missile would include radar, optics, and telemetry sites, and a launch control site. Figure 2.1.5-1 shows representative radar and telemetry equipment. Telemetry is provided through a real-time data acquisition system. Launch control is typically contained in a building, although mobile systems are also used (figure 2.1.5-2). Mobile systems would be brought to the selected location approximately 1 to 2 weeks before the launch date. In most cases the equipment would be removed within days after the launch.

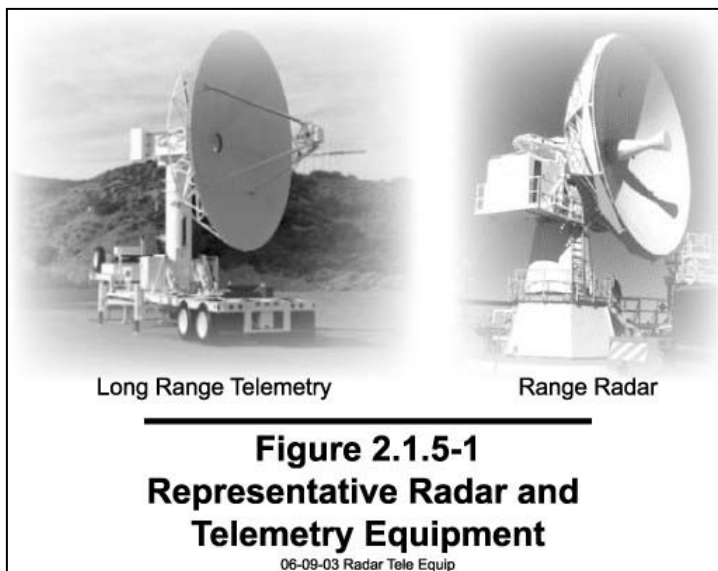

**2.1.5.1 Existing Range Sensors**

**2.1.5.1.1 Kodiak Launch Complex**

There are currently no sensors permanently located at KLC. Sensors would be brought in for each launch, as required for a particular operational scenario.

AADC is currently building two Range Safety and Telemetry System vans. Once this system is proven, it would be used as the Range Safety and Telemetry System for launches from KLC.

Additional instrumentation at KLC during a launch includes two mobile AN/FPS/MPS-36 class C-band radars, a mobile L-band surveillance radar, up to four mobile optical tracking systems, frequency surveillance antenna, and a transportable system to support mission preparation, data collection, processing, mission control, flight safety, and post mission data analysis.

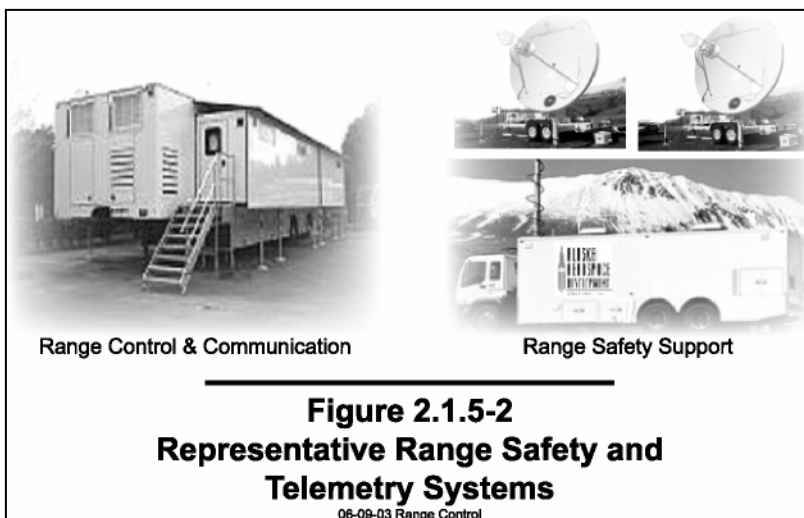

**2.1.5.1.2 Vandenberg Air Force Base**

Existing range sensors at Vandenberg AFB include several range radars (AN/TPQ-18, AN/FPS-16, High Accuracy Instrumentation Radar, and AN/MPS-39) as well as fixed and mobile telemetry and optics equipment.

### **2.1.5.1.3 Reagan Test Site**

Range sensors at RTS include the Advanced Research Project Agency Lincoln C-Band Observable Radar, and Long-range Tracking and Instrumentation. Both of these tracking radars are located on Roi-Namur at RTS. Additional radars include the Millimeter Wave Radar on Roi-Namur, Tracking and Discrimination Experiment Radar on Roi-Namur, and two MPS-36 C-band general-purpose instrumentation radars located at Kwajalein. The GBR-P is located on Kwajalein.

Telemetry sites located at Ennylabegan, Roi-Namur, and Gagan Islands include nine autotracking and three fixed antennas configured with multiple receivers and recorders. Optical sensors are also available at RTS.

### **2.1.5.1.4 Pacific Missile Range Facility**

Range Control and the Operation Control Centers are in the Barking Sands operations area on the main base. Tracking and surveillance radars, data processing, and the communications network hut are included in the operations area.

The Makaha Ridge Site, 12.9 kilometers (8 miles) north of the PMRF main base at an elevation of 457 to 549 meters (1,500 to 1,800 feet), features tracking and surveillance radars, primary telemetry receivers and recorders, a Frequency Monitoring Station, and Electronic Warfare and networked communications systems.

Kokee Park, 19.3 kilometers (12 miles) north and east of the PMRF main base, is at an elevation of 1,036 meters (3,400 feet). This site has tracking radars, telemetry, ultra-high frequency and very high frequency communications, and command and control systems. Niihau, a privately owned island, features a remotely operated PMRF surveillance radar.

## **2.1.5.2 Test Event and Mission Sensors**

### **2.1.5.2.1 Early Warning Radars**

#### **Eareckson Air Station Cobra Dane Radar**

The AN/FPS-108 Cobra Dane Radar System collects and disseminates exoatmospheric, multiple-object intelligence data. The Cobra Dane is a large L-band, computer-controlled, phased array radar system with local wide- and narrow-band communication systems, and an operations and test complex. A modernization effort has extended the Cobra Dane's operational life by 15 years and enhanced its performance to meet upgraded mission requirements. The upgrades include new hardware, including the signal and data processing system, receivers, displays, and software. Planned modification to the radar to support validation of the GMD operational concept would also support GMD ETR testing.

#### **Beale Air Force Base Early Warning Radar**

The Early Warning Radar at Beale AFB has a coverage that includes the West Coast of the continental United States. Planned modification to the radar to support validation of the GMD operational concept would also support GMD ETR testing.

## **Clear Air Force Station Early Warning Radar**

The Early Warning Radar at Clear Air Force Station has a coverage that extends from the Arctic Ocean to the West Coast of the continental United States. Previously planned modification to the radar to support GMD deployment would also support GMD ETR testing.

### **2.1.5.2.2 Midcourse Sensors**

#### **Cobra Judy**

Observation Island (Cobra Judy) is a U.S. Air Force shipboard phased array radar system. The Military Sealift Command is responsible for operating the ship, while the U.S. Air Force is responsible for operating the radar systems and overall mission accomplishment. Due to U.S. Air Force restructuring, the responsibility for mission accomplishment has been transferred to the Air Force Technical Applications Center, the U.S. Air Force Center of Excellence for providing national authorities with precision technical measurements to monitor treaty compliance.

Observation Island is a mobile platform that supports the Cobra Judy radar systems which are a national means for technical verification of foreign ballistic missile reentry systems. The instrumentation consists of the world's largest ship-borne phased array radar, a parabolic dish-type radar and a telemetry system.

#### **AN/SPY-1 Radar**

The Aegis weapon system is a multi-mission weapon system employed on both cruisers and destroyers. The AN/SPY-1 radar, although designed primarily for the Anti-Air Warfare mission, has been modified to perform the ballistic missile detection and tracking as part of its new capability to perform Theater Ballistic Missile Defense. The AN/SPY-1 radar is capable of collecting ballistic missile track data during the boost and ascent phase of the missile. The radar would be integrated into the GMD Communications Network as an external-reporting sensor for the GFC/C.

Based on planned interceptor flight test target trajectories, AN/SPY-1 radar would establish the appropriate search fences to detect the target based on planned target launch points. On-ship radar mission operators would monitor the test control network to determine target launch time and status. Upon acquisition of the target, the radar would place the target under track and initiate track reporting.

#### **TPS-X Radar**

This radar is an aircraft transportable wide band, X-band, single faced, phased array radar system of modular design. The radar consists of five individual units: Antenna Equipment Unit, Electronic Equipment Unit, Cooling Equipment Unit, Prime Power Unit, and Operator Control Unit. The Antenna Equipment Unit includes all transmitter and beam steering components as well as power and cooling distribution systems. The Electronic Equipment Unit houses the signal and data processing equipment, operator workstations, and communications equipment. The Cooling Equipment Unit contains the fluid-to-air heat exchangers and pumping system to cool the antenna array and power supplies. The Prime Power Unit would be used to power the radar system or act as a standby power source if commercial power is available. The Prime Power Unit is a self-contained trailer with a noise-dampening shroud that contains a diesel

generator, governor, and associated controls, a diesel fuel tank, and air-cooled radiators. The Antenna Equipment Unit, Electronic Equipment Unit, Cooling Equipment Unit, and Prime Power Unit are housed on separate trailers interconnected with power and signal cabling, as required (see figure 2.1.5-3). Potential locations for the TPS-X radar include one site at KLC, previously disturbed areas at PMRF, and existing, previously analyzed sites at RTS and Vandenberg AFB.

**AN/FPQ-14 Radar**

The AN/FPQ-14 radar performs range tracking functions and is located at Kaena Point, Oahu, Hawaii. The radar is operated by the Air Force, 22nd Space Operations Squadron assigned to the 50th Space Wing, Schriever AFB, Colorado.

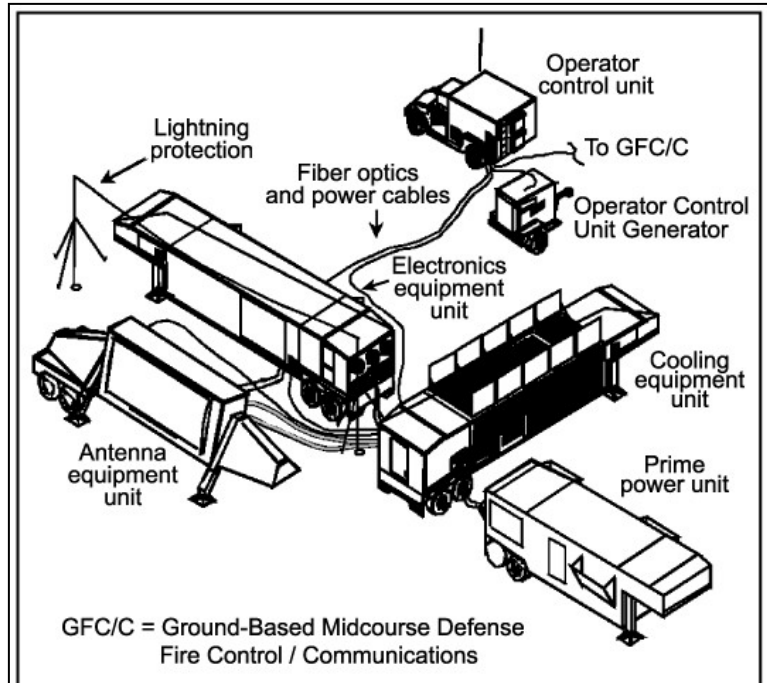

**Figure 2.1.5-3**  
**TPS-X Radar Components**  
06-09-03 Radar Comp

**2.1.5.3 Mobile Telemetry Systems and Mobile C-Band Radar**

The Mobile Telemetry Systems would consist of an 11-meter (37-foot) truck, two 5.4-meter (17.7-foot) antennas, and dual 10-kW generators. Figure 2.1.5-4 shows representative mobile telemetry equipment including the mobile telemetry and an instrumentation trailer. The mobile C-band radar would perform range tracking functions. A relatively level area or improved road would be required to site the systems. Intended operations would be to pull the telemetry and radar equipment into a prepared area and utilize a commercial power drop.

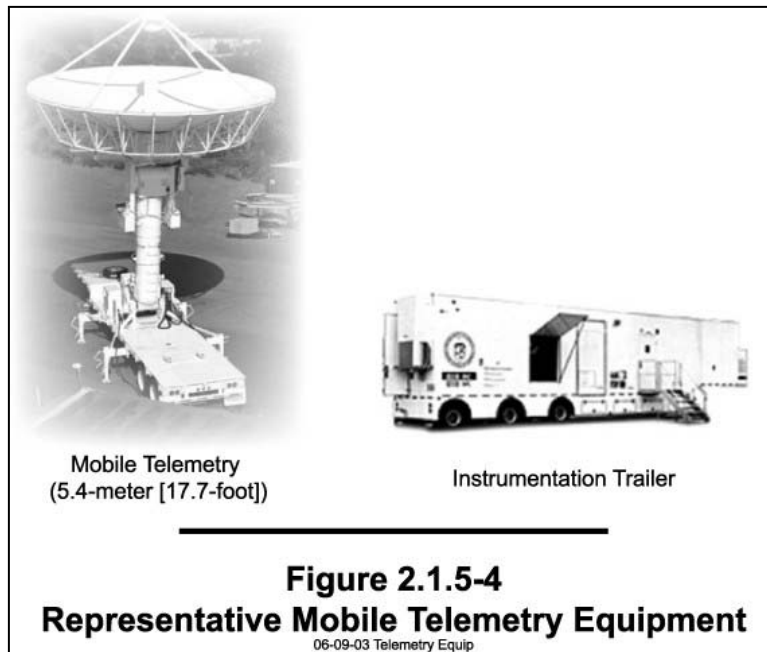

**Figure 2.1.5-4**  
**Representative Mobile Telemetry Equipment**  
06-09-03 Telemetry Equip

Generators would provide a backup source of power. Uninterrupted Power Supplies are contained in each unit as an emergency backup if power is lost during a test flight.

Mobile Telemetry Systems and radar would be required to support the flight testing as a part of the proposed GMD action. Target telemetry and radar requirements include an up-range, mid-range, and down-range telemetry system to support launches. Figure 2.1.5-5 shows potential mobile telemetry locations.

Up-range telemetry and radar locations in Alaska that may be used include:

- KLC
- Pasagshak Point
- Homer
- King Salmon
- Adak
- Cordova
- Pillar Mountain

Mid-range telemetry and radar locations could include:

- Makaha Ridge, Hawaii (existing telemetry)
- PMRF, Hawaii (existing telemetry)
- Pillar Point, California
- Midway
- Bremerton, Washington

Downrange telemetry and radar locations could include:

- Wake Island (existing telemetry)

## **2.1.6 FLIGHT TEST PLANNING AND OPERATIONS**

The target launch site would be occupied for approximately 2.5 months before a scheduled launch and 2 weeks after a launch. A typical 3-month launch cycle ramp-up would include 25 people during the first month, 55 to 75 people during the second month, and 110 to 150 people during the third month. Dual launch would include 25 people during the first month, 75 to 90 people during the second month, and 150 to 175 people during the third month. After a launch, approximately 50 personnel would immediately depart, and the remaining personnel would depart after launch site refurbishment.

For the GBI launch site, a typical launch cycle ramp-up would include 55 to 65 people during the first month, 100 to 130 people during the second month, and 205 to 260 people during the third month. Dual launch would include approximately 55 to 65 people during the first month, 120 to 150 people during the second month, and 235 to 300 people during the third month. After a launch, approximately 75 personnel would depart immediately.



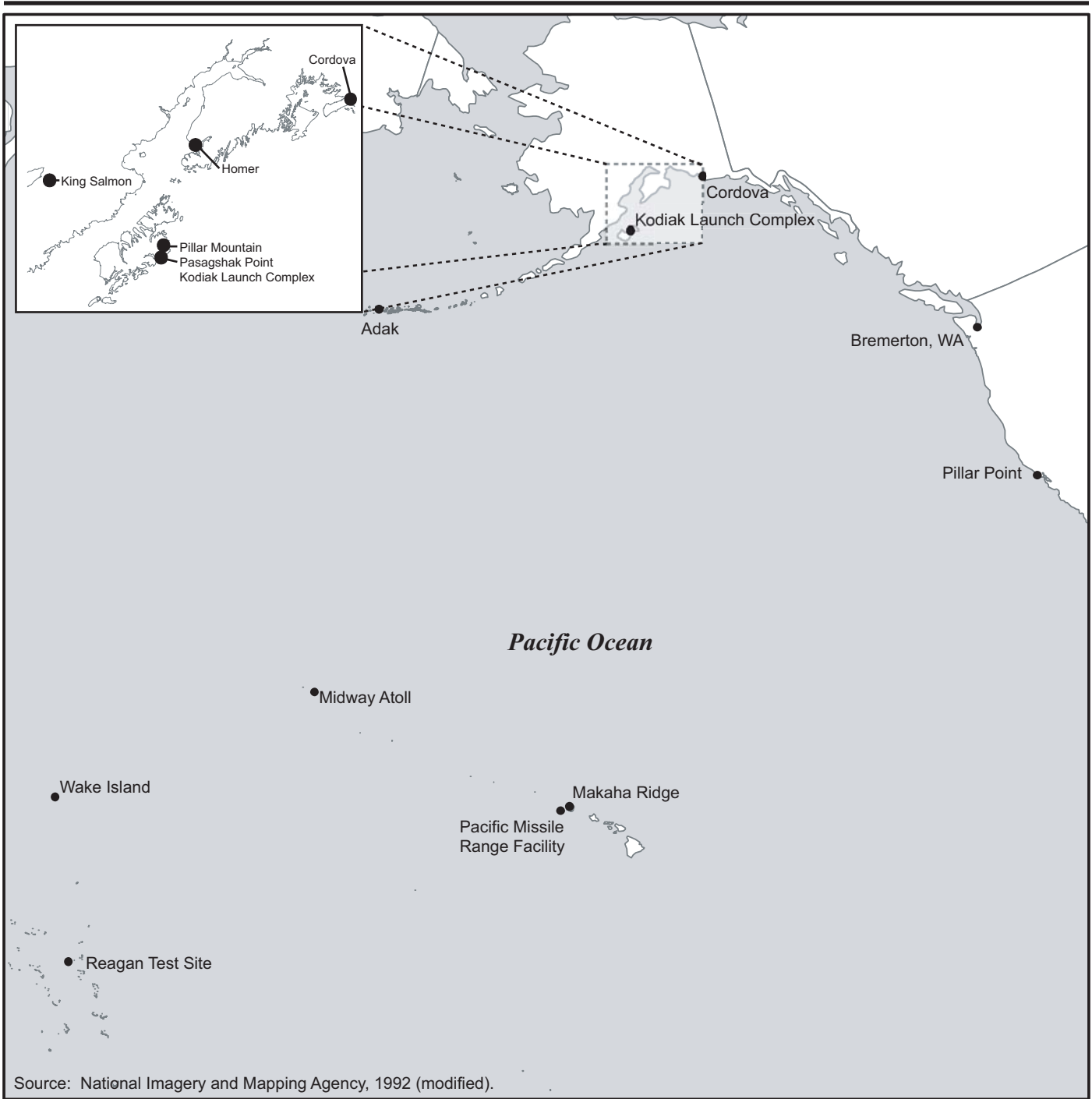

**EXPLANATION**

Note: Although Midway was an alternative site in the Draft EIS, MDA has determined that it is no longer a reasonable alternative and will not be a proposed site for ETR activities. The IDT on-board the SBX would perform the function that had been planned for Midway. The discussion of Midway has been retained in the Final EIS, however, in order to preserve the work that has already been performed.

**Mobile Telemetry  
Location Alternatives**

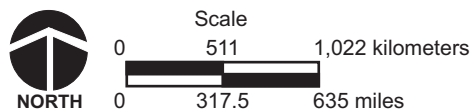

Pacific Ocean

**Figure 2.1.5-5**

Interceptor and target missile contractor test personnel would be housed in motels, hotels, or mancamps in the vicinity and would commute to the launch site daily. U.S. Government and military test personnel may use military or commercial lodging if available.

#### **2.1.6.1 Explosive Safety Quantity–Distances**

An ESQD is established to account for the possibility of an unplanned event. Such an event would be characterized by either an explosion of the missile propellants or by the propellants burning without an actual explosion. An ESQD zone surrounding the explosives would be calculated in accordance with DoD Standard 6055.9, *Ammunition and Explosives Safety Standards*, and would consider factors such as the hazard classification of the explosive and actual test results for that explosive. The ESQD determination would be based on the equivalent explosive force of all propellant and pyrotechnic materials involved. Establishment of the ESQD zone represents DoD's determination that areas outside the zone provide acceptable protection, and requires that areas inside the ESQD zone be cleared of non-mission-essential personnel for the entire period during which the explosives are present. Additionally, fire suppression, hazardous materials emergency response, and emergency medical teams would routinely be provided during the actual launch operations.

#### **2.1.6.2 Typical Flight Test**

The duration of a typical test flight would be approximately 20 to 30 minutes. Airspace surveillance procedures would last as little as 45 minutes, or as long as 3.5 hours if the test is delayed, after which it would be rescheduled. After launch, the missile would slowly gain speed in the first few seconds of flight, and then rapidly accelerate out of sight and earshot.

Approximately 1 minute into flight, the target missile would be at an altitude of approximately 19.3 kilometers (12 miles). The first stage would burn out and fall within the predicted booster impact area. The second and third stages would perform in similar manners, and the target missile would climb out of the atmosphere and into space. The target would reenter the atmosphere and decelerate until it is intercepted or impacts into the Pacific Ocean.

The tracking radar would acquire and track the target while the interceptor command and control system computes the best time to launch the interceptor missile. The interceptor missile would then be launched. Approximately 1 minute into flight, the interceptor would be at an altitude of 50 kilometers (31 miles) and approximately 65 to 80 kilometers (40 to 50 miles) downrange. The first stage would burn out and fall within the predicted booster impact area. The second and third stages would ignite, and the interceptor would continue toward the intercept point. After burnout, the second and third stages would fall into the ocean. The EKV would be deployed after third stage burnout. If the intercept is unsuccessful, the EKV would reenter the atmosphere and is anticipated to burn up on reentry. All booster stages would be programmed to land in predetermined and verified clear areas. Intercept altitudes could vary from approximately 100 to more than 250 kilometers (62 to 155.3 miles).

Intercept debris is the result of the collision between the target missile descending on its reentry trajectory and an interceptor missile moving horizontally or in a slight descent toward the target. For the most part, the target missile debris would continue downward, along the path toward its intended impact point. Similarly, the interceptor missile debris would continue along its path until gravity takes over and the pieces fall to Earth.

The most likely outcome of a successful intercept would be a few large pieces (tens of kilograms), more medium size pieces (less than a kilogram), and mostly small pieces of missile debris (less than 10 grams [0.35 ounces]). Some of the pieces would be small and heavy and have a low coefficient of drag. Others would be larger and lighter and have a high coefficient of drag. Each piece of debris would also have its own kinetic energy, which would be a function of its mass (how heavy it is) and its velocity (how fast it is). A heavy, fast piece of debris has more kinetic energy than a smaller, slower piece of debris. Air resistance, especially wind, has a large influence on where debris lands. A typical target missile reentry vehicle may weigh approximately 884.5 kilograms (1,950 pounds). A typical interceptor kill vehicle may weigh about 110 kilograms (240 pounds) at intercept. If an intercept is not successful, both the target and interceptor missiles would fall into the Pacific Ocean within designated clearance zones. Under normal conditions, missile components would not be recovered from the ocean.

### **2.1.6.3 Flight Test Clearance Areas**

When a missile flight test is planned, there are certain areas where missile components and debris are expected to impact, called the booster drop zone and the debris impact area. These areas are verified safe as part of the test plan. There are other areas where debris may land if the test does not proceed as planned. These predetermined areas may be subject to the risk of mishap, such as an explosion or flight termination. Clearance areas are defined by the Range Safety Office to encompass the maximum probable distribution of debris or impact points of missile components. Figure 2.1.6-1 depicts typical GMD flight test clearance areas.

Each missile flight test event would be modeled using computer predictions of the behavior of the missiles. This modeling predicts what the missile may do in a number of situations where the missile, or parts of the missile, would fall to Earth. The models incorporate a number of variables such as the missile mass, velocity, trajectory, altitude, and descriptions of the environments that may affect the missile in flight, such as surface and high altitude winds.





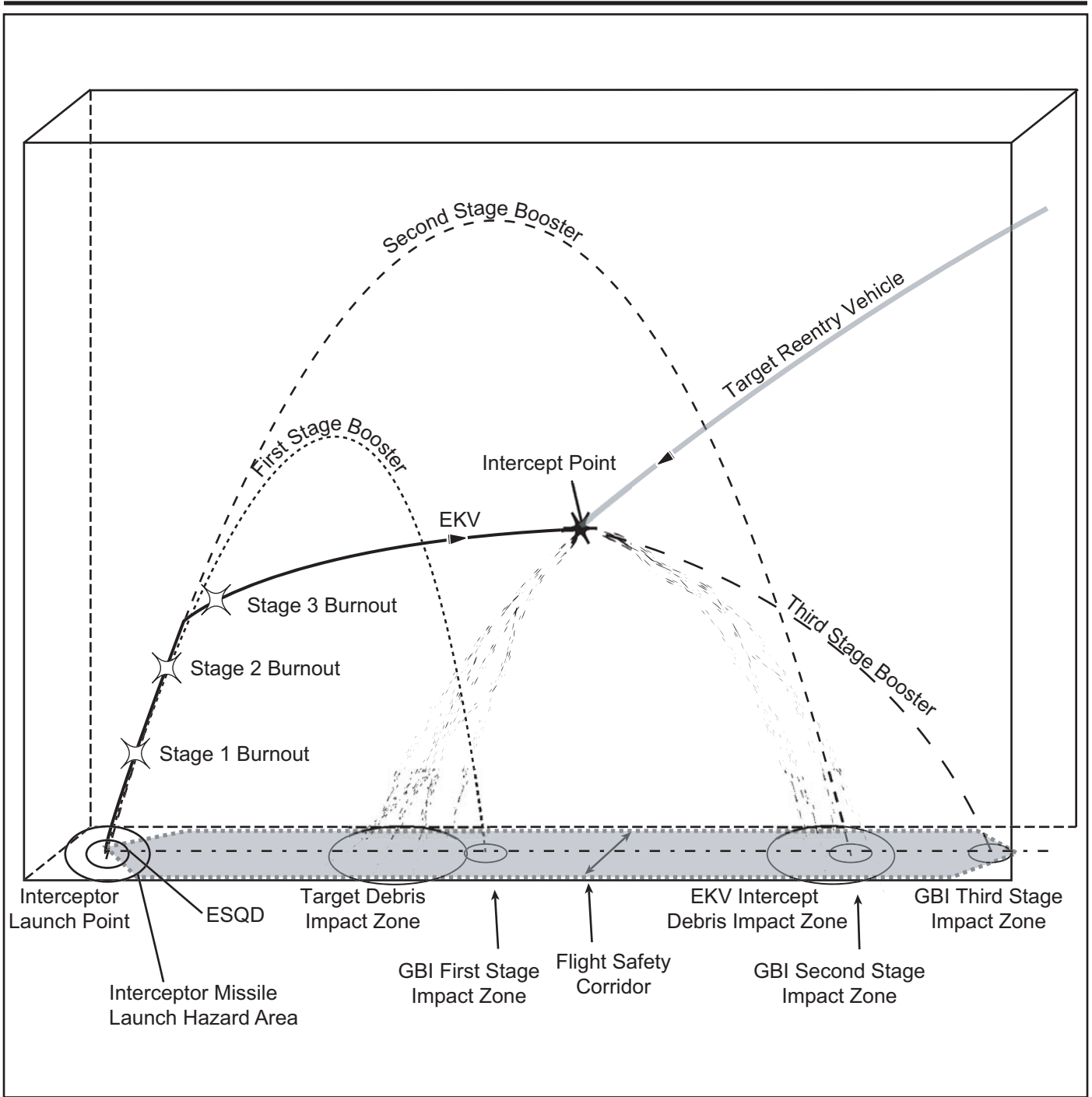

Modeling that is done long ahead of the actual test would use average weather predictions. Modeling would be done on the day of test to verify safety under actual test conditions.

The Range Safety Office would communicate the extent of the clearance area, time, and date of the flight test, once they are defined, to the FAA, the U.S. Coast Guard, appropriate emergency management agencies, and local police jurisdictions for assistance in the clearance of designated land and sea-surface areas. Other areas under the flight path but not in a predicted impact or debris area would be monitored before the test event to determine the location of population or traffic. If the Range Safety Office determined that the population or ship traffic was in a safe position, the test would proceed.

Ground and range safety areas are developed to protect the public and private property against potential test mishaps. These safety areas are defined in terms of three scenarios: termination or explosion on the ground, either in the Missile Assembly Building or storage areas, or on the launch pad; termination of a missile's flight shortly after liftoff; and termination of a missile's flight after it has left the vicinity of the launch site.



**EXPLANATION**

-  Flight Safety Corridor
-  Ground Projection of Flight Path
-  First Stage Booster Flight Path
-  Second Stage Booster Flight Path
-  Third Stage Booster Flight Path
-  Interceptor Flight Path
-  Ballistic Missile Flight Path

EKV = Exoatmospheric Kill Vehicle  
 ESQD = Explosive Safety Quantity Distance  
 GBI = Ground-Based Interceptor

**Typical GMD Flight Test Clearance Areas**

Not to Scale

**Figure 2.1.6-1**

#### **2.1.6.4 Launch Hazard Areas**

Before MDA would launch a missile, the Range Safety Office would determine if the missiles could be safely launched from the proposed location. To do this, the Range Safety Officer develops a Launch Hazard Area around the proposed launch site. The Launch Hazard Area is the area that could be affected by pieces of missile debris should an explosion occur just above the launch pad or in the event that the missile's flight must be terminated in the early flight phase. This Launch Hazard Area is cleared of all but mission-essential test personnel during launch operations. Appendix C, Missile Launch Safety and Emergency Response, addresses Representative Launch Hazard Areas for each proposed launch location.

#### **2.1.6.5 Flight Corridor**

Another component of range safety is based on the possibility of a flight termination after the missile has exited the vicinity of the launch pad. A termination of this kind would occur in the event of an off-course flight. Mission planning and procedures would ensure the Flight Termination System would be activated in time for the flight vehicle to fall within its predicted flight corridor in the event of an off-course flight.

Should the missile head off course such that it is leaving its predicted flight corridor, the Range Safety Officer would activate the Flight Termination System. This would stop the flight vehicle's thrust, and the missile pieces would then fall ballistically into the sea. This impact could occur outside cleared areas, but within a predetermined flight corridor.

### **2.1.7 FLIGHT TEST SAFETY**

Once a test event is scheduled, there would be a standard sequence of notification and coordination procedures between the Range Safety Office and the agencies that would enforce the clearance of land, air, and sea areas. These areas are discussed below. The date and location of scheduled flight tests or training events would be published approximately 1 week in advance as described below for land, air, and sea areas.

#### **Land Areas**

Land areas that would need to be cleared are the Launch Hazard Area for each missile. Land areas would be cleared in cooperation with appropriate local law enforcement officials. Land areas would need to be cleared approximately 1 to 4 hours before a launch. As soon as the Range Safety Officer determines that the area is safe, the Launch Hazard Area could be reoccupied.

A Notice of Intent to clear certain land areas for safety reasons would be published in the local newspapers and broadcast in the local news media. The boundaries of Launch Hazard Areas would be posted with notifications. The areas would be closed approximately 1 to 4 hours before the planned launch and guarded to ensure they remain clear of non-mission personnel.

#### **Airspace**

FAA-controlled airspace is that in which most commercial aviation operates; that is, airspace up to an altitude of 18,288 meters (60,000 feet). Military Special Use Airspace may extend to higher altitudes, depending upon the individual restricted or warning area. The missiles involved in these GMD flight tests rapidly climb through this airspace and follow trajectories

high above this airspace. FAA-controlled airspace that would be affected includes airspace above the Launch Hazard Area for both the interceptor and the target launches, airspace above the booster drop zones, airspace above the predicted debris impact zone, and airspace above the predicted interceptor missile and target reentry vehicle impact zones if there is not an intercept.

Debris modeling for the day of test would predict the dispersion and linger time for test impact debris. Linger time is the time it would take for debris as small as 1 gram (0.04 ounce) to fall to Earth given the weather conditions at the time. Such small debris is important because it could be ingested into aircraft engines in flight, causing them to fail. This debris dispersion area may also have to be cleared of aircraft for some time after an intercept. Airspace would need to be cleared in advance of a planned test event to allow sufficient time to ensure that it is indeed clear; this would be approximately a half-hour before test launch. As soon as the Range Safety Officer determines that the area is safe, the airspace could be reoccupied. It could be as long as 2 to 4 hours before a debris dispersion area is declared clear.

The FAA would publish a NOTAM to avoid certain airspace areas for safety reasons. Conditions that are expected to exist for an extended period of time are reported in a Flight Data Center or NOTAM, and are published in the next biweekly NOTAM publication. The boundaries of Launch Hazard Areas would be posted with notifications, and range radar and aircraft would patrol the airspace to ensure that it is clear of aircraft before each flight test.

### **Sea-Surface Areas**

Sea-surface areas that would have to be cleared include the Launch Hazard Area that extends over water, the predicted booster drop zones, the predicted debris impact zone, and the predicted impact zone for the interceptor missile and reentry vehicle. Sea-surface areas would be cleared with the cooperation of the U.S. Coast Guard. Sea-surface areas would need to be cleared in advance of a planned test event to allow sufficient time to ensure that it is indeed clear; this would be approximately 4 hours before test launch. As soon as the Range Safety Officer determines that the area is safe, the sea-surface areas could be reoccupied.

The Coast Guard would publish a NOTMAR to clear certain sea-surface areas for safety reasons. A Notice of Intent to clear certain sea-surface areas for safety reasons would be published in local newspapers, broadcast in local news media, and distributed to commercial fishing and tourist boating trade associations. Subject to the conditions of appropriate Memoranda of Agreement, U.S. Coast Guard officials would close the sea-surface area(s) up to 4 hours before the planned launch and then survey them to ensure that they are clear of ships or watercraft. Typically, U.S. Coast Guard vessels and range safety aircraft would patrol the area to ensure that it is clear of ships or watercraft.

Each missile in a flight test is tracked by a variety of sensor equipment to determine exactly where the missile is at all times during the flight. This tracking provides useful data to the program to satisfy test objectives as well as a range safety tool. The Range Safety Officer uses the real-time tracking capability, linked with the predictive modeling capability, to predict at any moment in the flight where the missile may land if thrust were terminated at that moment. This prediction is called an instantaneous impact point. Should a missile veer from its predicted flight path, the impact point predicts where it would fall. If the missile is predicted to leave the flight corridor or clearance areas, the Range Safety Officer would terminate the flight.

### **2.1.7.1 Post-Test Clearance Release**

After completion of a missile flight test, the clearance areas would be released, or allowed to be re-entered. The Range Safety Officer would release the clearance areas as soon as he or she was assured that any hazardous aspect of the test was completed. Residual hazardous concerns may be gases from missile exhaust, presence of hazardous debris, debris still falling after an intercept, or other potentially dangerous consequences. Notification would be by radio, telephone, or computer to aviation and maritime authorities.

### **2.1.7.2 Debris Recovery**

Following a successful intercept, debris would not normally be recovered from the Pacific Ocean. Potential debris from Air Launch Targets could include the target impact debris, pallet, and parachutes. Pallet debris could include metal fragments. The pallet and associated debris impacting the open ocean would sink and would not be recovered.

Recovery of missile and missile components after unsuccessful launches would be conducted in accordance with all applicable range procedures. If required, debris recovery may involve the use of helicopters and off-road vehicles. If the potential exists to disturb biological or cultural resources during debris recovery activities, recovery efforts would be coordinated with applicable range representatives and agencies to develop appropriate mitigation measures to avoid impact to sensitive resources and to restore natural areas as necessary following debris recovery efforts. After a successful launch, ground equipment would be parked and the site secured.

### **2.1.7.3 Mishap Response**

Mishaps are, by definition, unplanned events, but they are not unforeseen. The Range Safety Officer would anticipate mishaps and plan responses ahead of time. These response plans both minimize the potential harm and speed recovery from the mishap. Flight termination is accomplished by stopping the propulsive thrust of the rocket motor. This is done by splitting the motor casing with a linear-shaped explosive charge or blowing open thrust ports, which releases the compression on the burning fuel. The linear-shaped charge or thrust ports are activated by a redundant Flight Termination System using radio signals from the Range Safety Officer. When thrust is terminated, the missile pieces continue along the current flight path and fall to Earth under the influence of gravity. Mishap scenarios and their consequences are described in chapter 4.0. Each launch location has an emergency response plan that includes the appropriate response to a launch-related mishap as described in appendix C.

## **2.1.8 FLIGHT TEST EXAMPLE SCENARIOS**

As part of the alternatives for implementing the Proposed Action, interceptors launched against targets may originate from KLC, Vandenberg AFB, or RTS. Target missiles launched as a part of this ETR program may originate from KLC, Vandenberg AFB, PMRF, RTS, or from the MLP sea launch, or from an air launch platform in the Pacific region. All missile intercepts would occur over the Pacific Ocean. In the event the interceptor misses the target, the interceptor and target missiles would land in the Pacific Ocean. Under normal conditions, missile components would not be recovered from the Pacific Ocean.

Several examples of interceptor and target missile flight test trajectories are presented here to illustrate representative testing events that could occur as part of the GMD ETR test schedule (figures 2.1.8-1 through 2.1.8-6). These examples are meant to show representative GMD flight

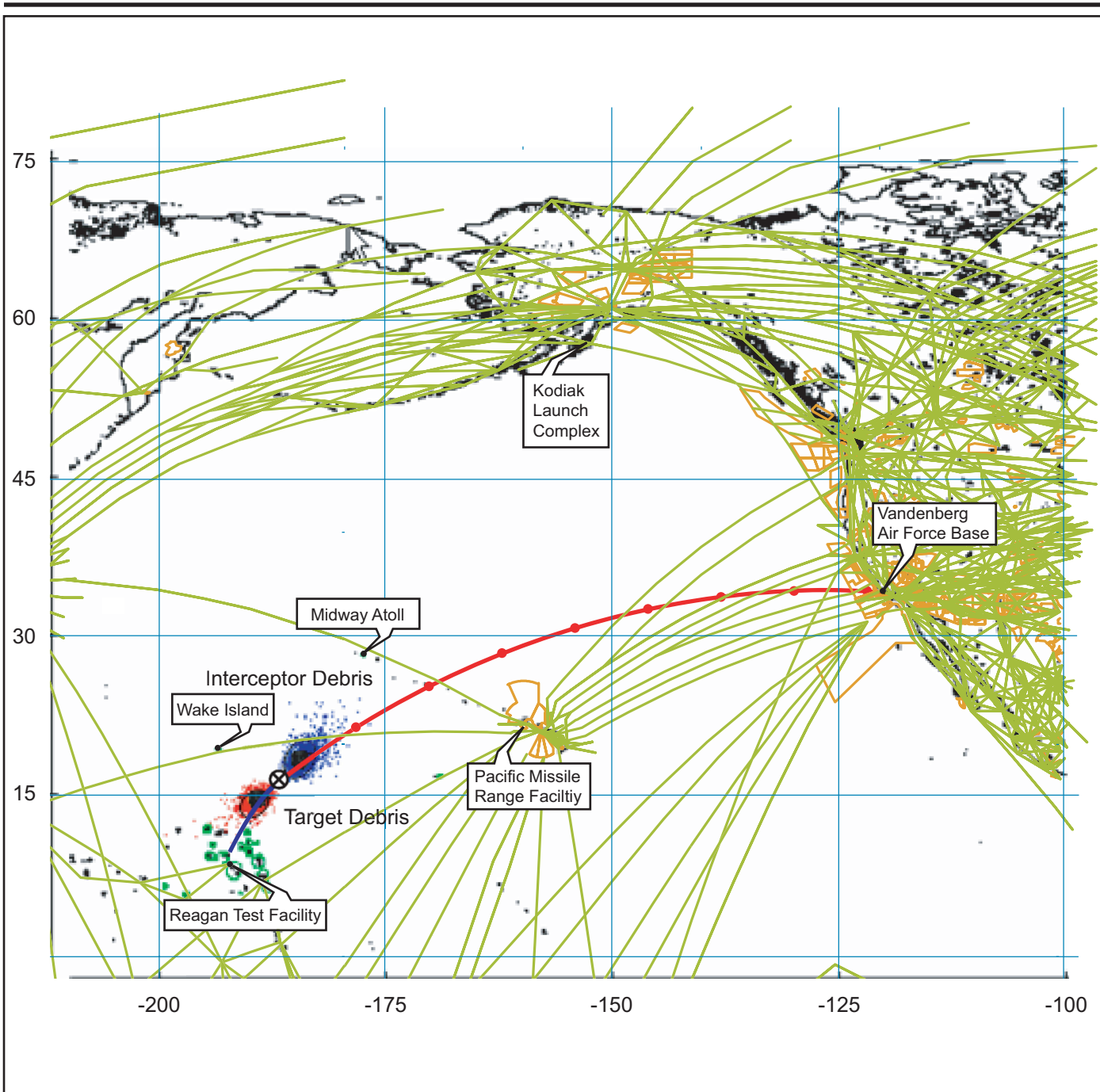

Source: 3D Research Corporation, 2001a (modified); National Imagery and Mapping Agency, 2002.

**EXPLANATION**

- Ground-Based Interceptor (GBI) Trajectory
- Target Trajectory
- 11 ft-lb Injury Debris
- 1 Gram GBI Missile Debris
- 1 Gram Target Missile Debris

- ⊗ Intercept Point
- Note: 76 ft-lb Debris is Contained Within the Area Shown as 11 ft-lb Debris
- Special Use Airspace
- High Altitude Jet Routes

**Scenario 1: Target Launched from Vandenberg Air Force Base, Intercepted from Reagan Test Site**

Pacific Ocean

**Figure 2.1.8-1**



Not to Scale

06-09-03 Scenario 1



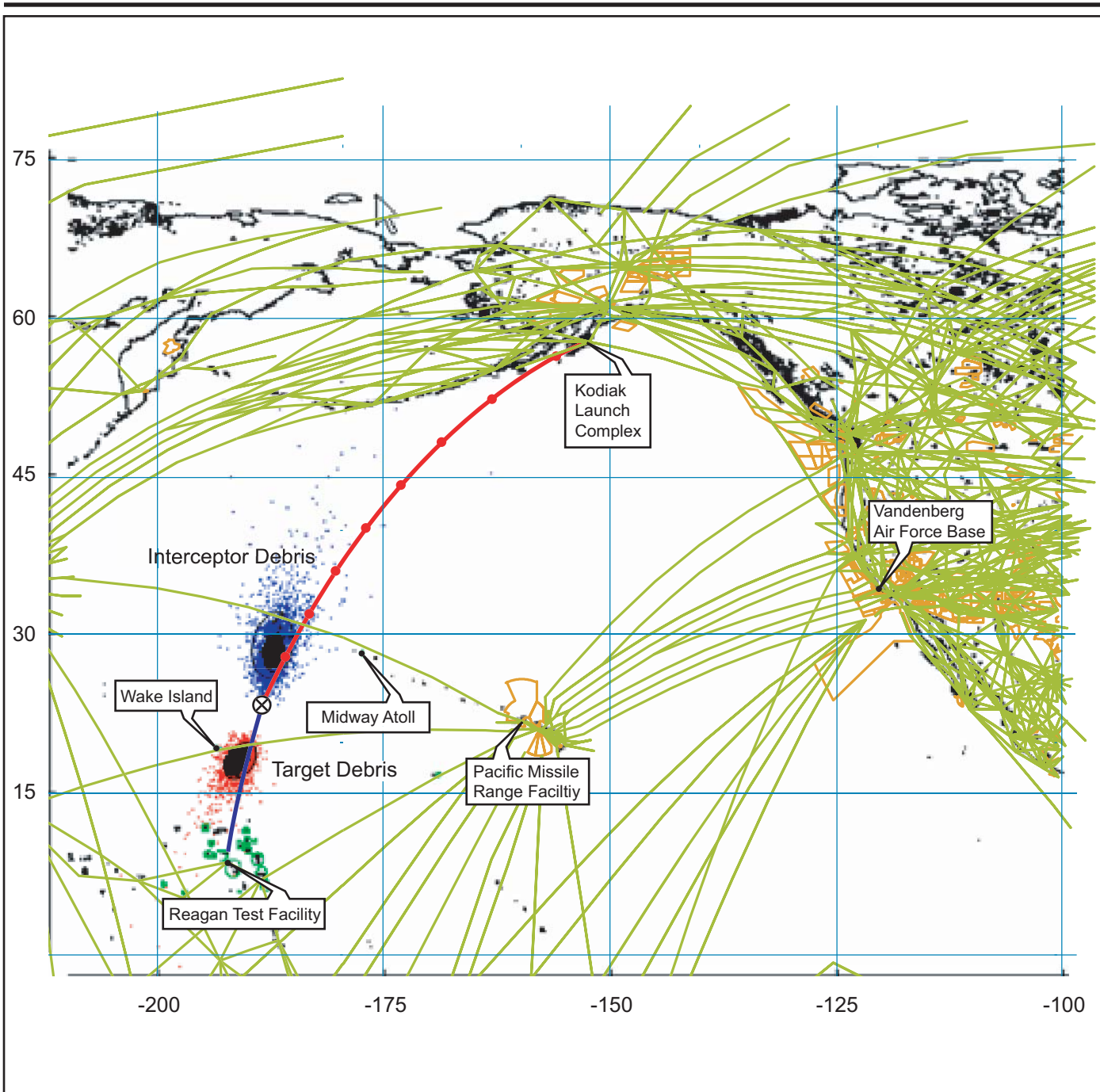

Source: 3D Research Corporation, 2001a (modified); National Imagery and Mapping Agency, 2002.

**EXPLANATION**

- Ground-Based Interceptor (GBI) Trajectory
  - Target Trajectory
  - 11 ft-lb Injury Debris
  - 1 Gram GBI Missile Debris
  - 1 Gram Target Missile Debris
  - Special Use Airspace
  - High Altitude Jet Routes
  - ⊗ Intercept Point
- Note: 76 ft-lb Debris is Contained Within the Area Shown as 11 ft-lb Debris

**Scenario 2: Target Launched from Kodiak Launch Complex, Intercepted from Reagan Test Site**

Pacific Ocean

**Figure 2.1.8-2**



Not to Scale

06-09-03 Scenario 2

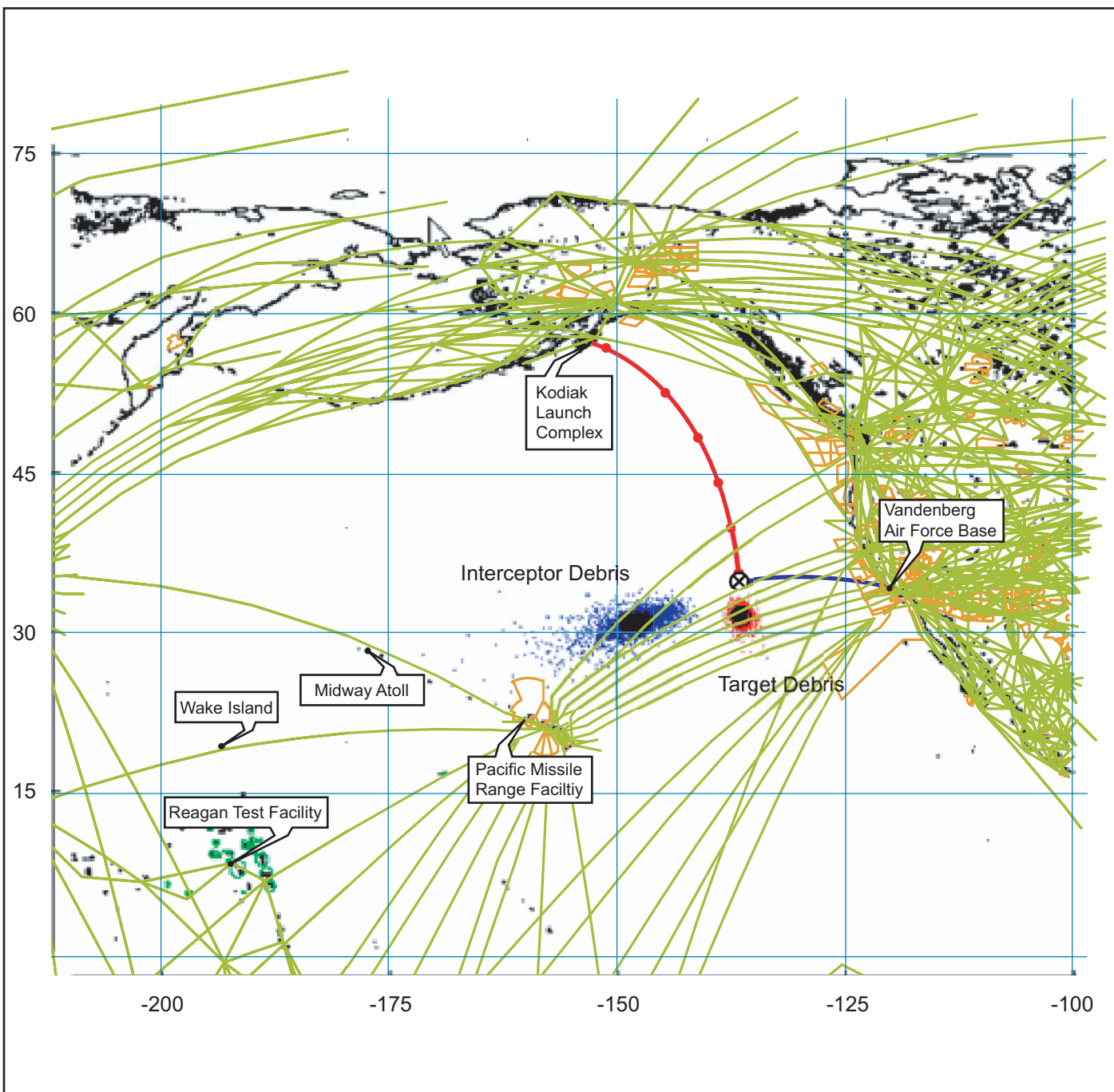

Source: 3D Research Corporation, 2001a (modified); National Imagery and Mapping Agency, 2002.

**EXPLANATION**

- Ground-Based Interceptor (GBI) Trajectory
- Target Trajectory
- 11 ft-lb Injury Debris
- 1 Gram GBI Missile Debris
- 1 Gram Target Missile Debris
- ⊗ Intercept Point
- Note: 76 ft-lb Debris is Contained Within the Area Shown as 11 ft-lb Debris
- Special Use Airspace
- High Altitude Jet Routes

**Scenario 3: Target Launched from Kodiak Launch Complex, Intercepted from Vandenberg Air Force Base**  
Pacific Ocean



Not to Scale

**Figure 2.1.8-3**

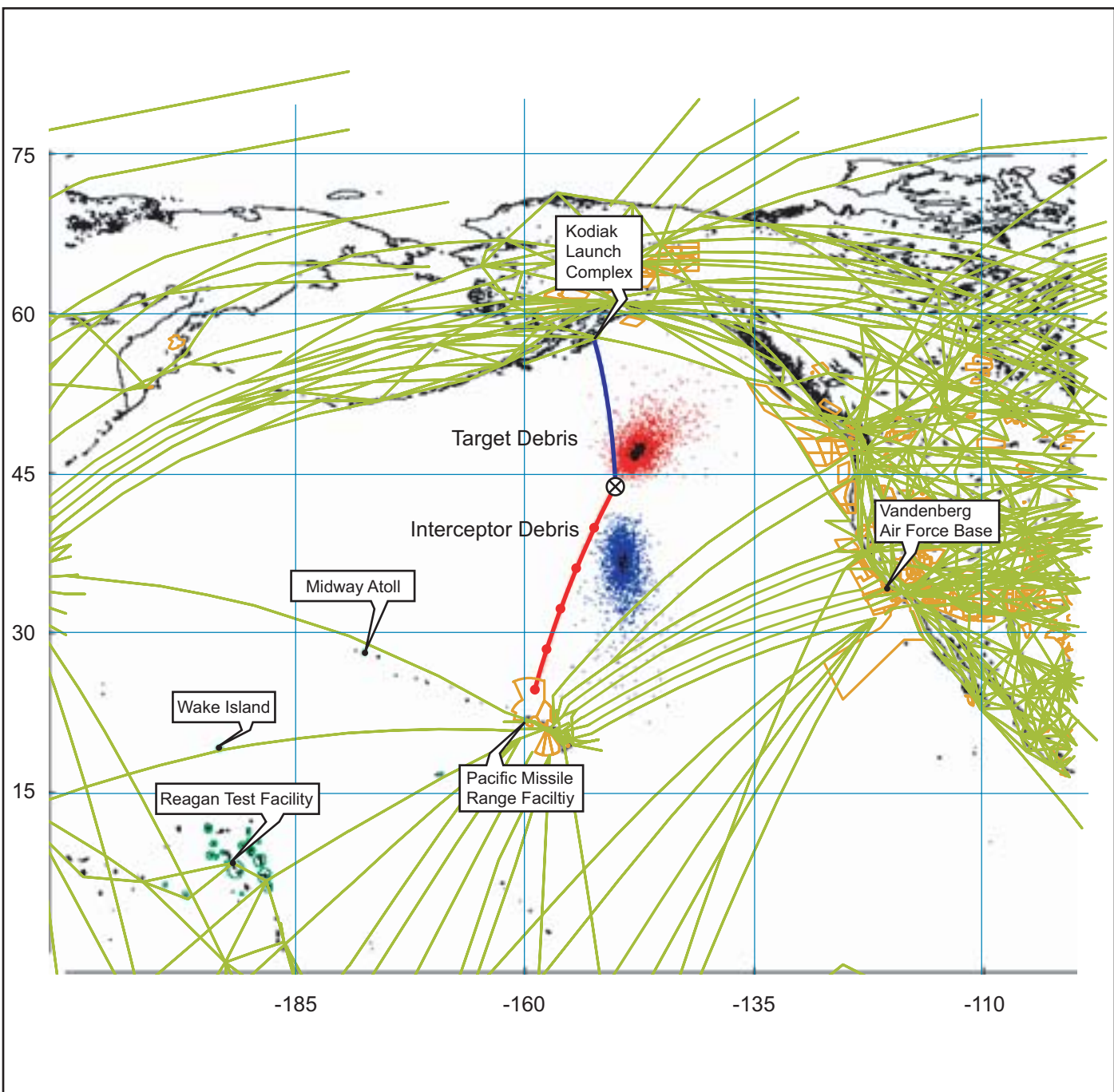

Source: 3D Research Corporation, 2001a (modified); National Imagery and Mapping Agency, 2002.

**EXPLANATION**

- Ground-Based Interceptor (GBI) Trajectory
- Target Trajectory
- 11 ft-lb Injury Debris
- 1 Gram GBI Missile Debris
- 1 Gram Target Missile Debris
- ⊗ Intercept Point
- Note: 76 ft-lb Debris is Contained Within the Area Shown as 11 ft-lb Debris
- Special Use Airspace
- High Altitude Jet Routes

**Scenario 4: Target Launched from Pacific Missile Range Facility, Intercepted from Kodiak Launch Complex**

Pacific Ocean



Not to Scale

**Figure 2.1.8-4**

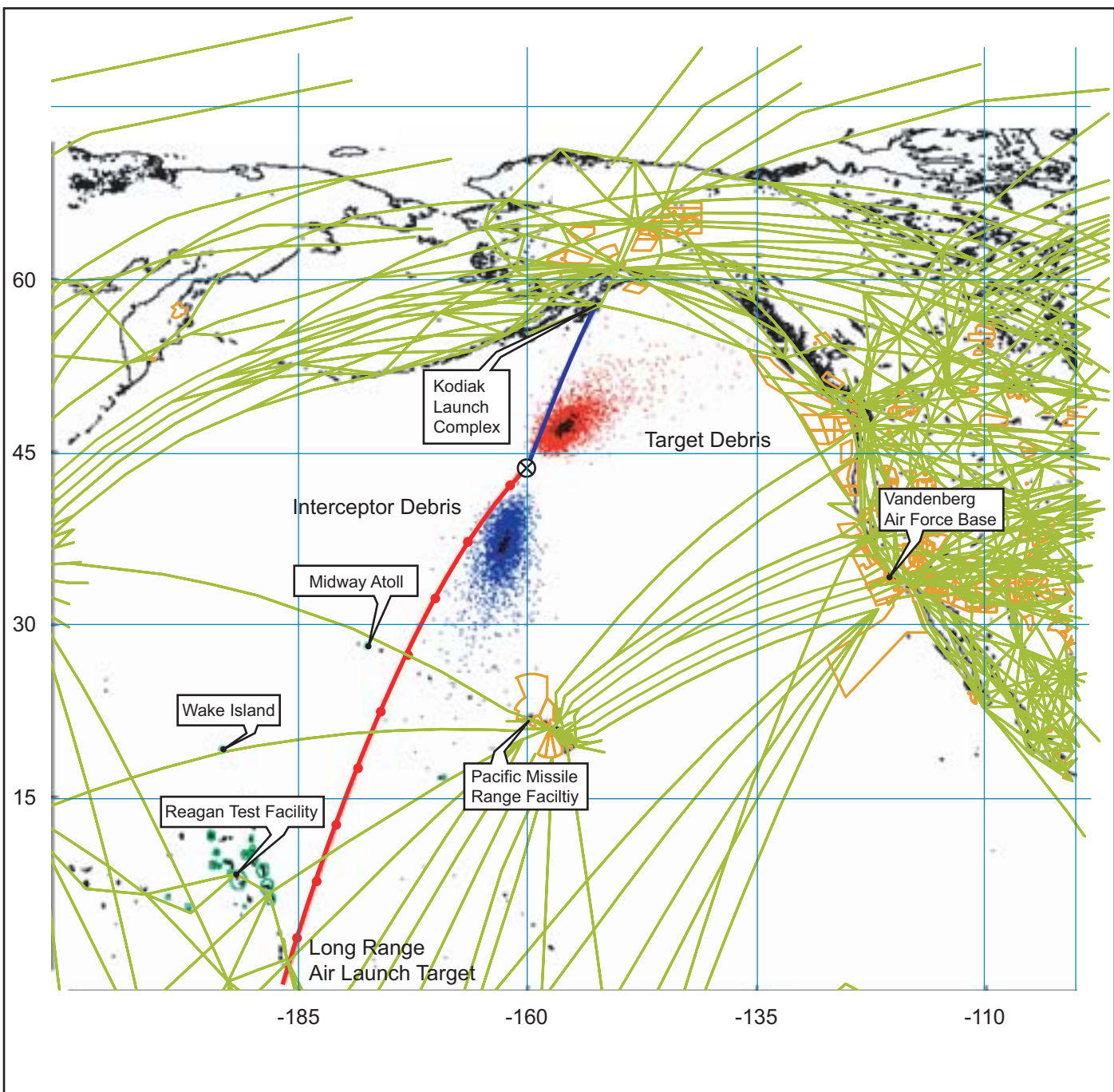

Source: 3D Research Corporation, 2001a (modified); National Imagery and Mapping Agency, 2002.

**EXPLANATION**

- Ground-Based Interceptor Trajectory
- Target Trajectory
- 11 ft-lb Injury Debris
- 1 Gram Interceptor Missile Debris
- 1 Gram Target Missile Debris
- ⊗ Intercept Point
- Note: 76 ft-lb Debris is Contained Within the Area Shown as 11 ft-lb Debris
- Special Use Airspace
- High Altitude Jet Routes

**Scenario 5: Air Launch Target, Intercepted from Kodiak Launch Complex**

Pacific Ocean

**Figure 2.1.8-5**



Not to Scale

06-09-03 Scenario 5

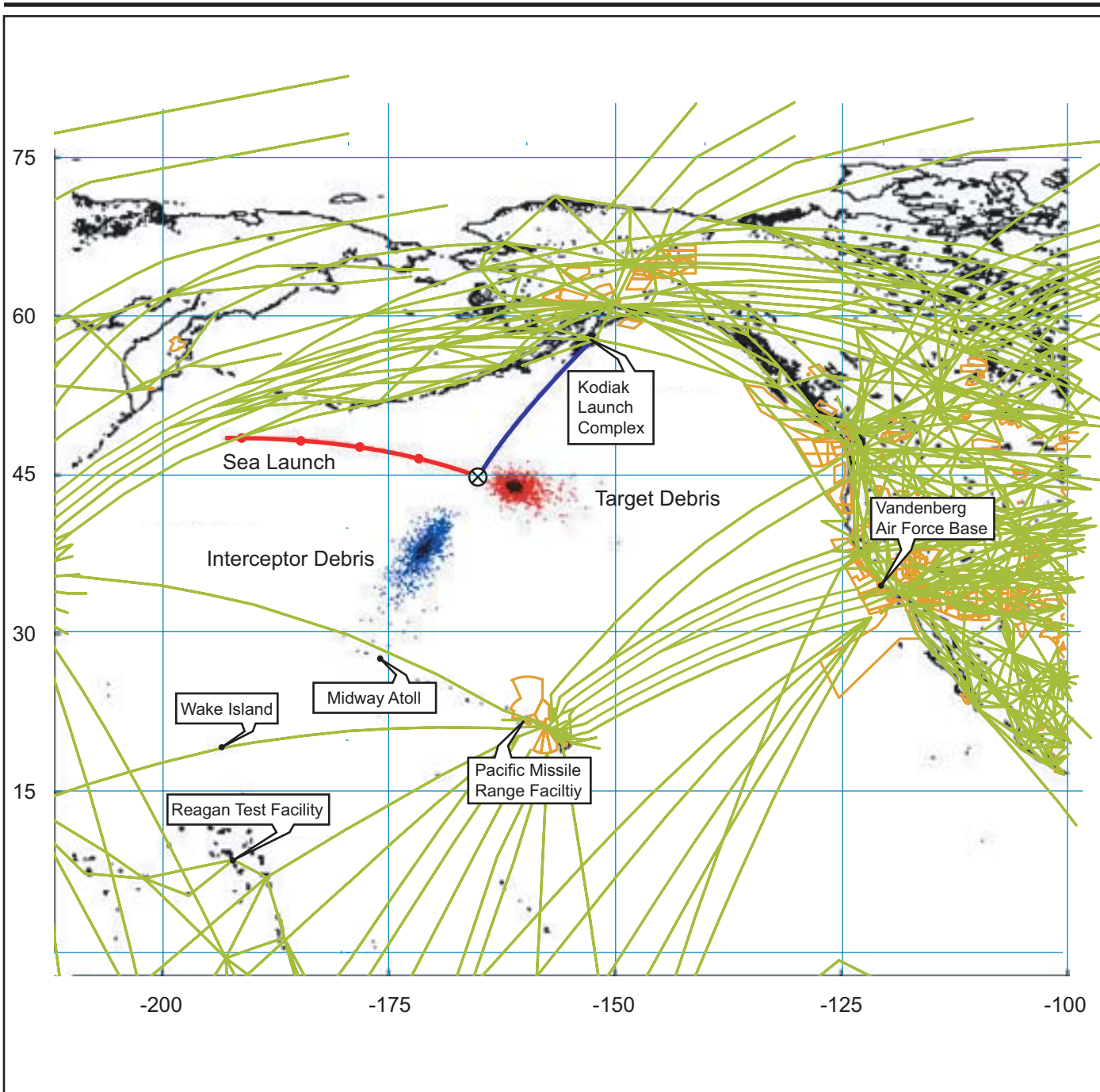

Source: 3D Research Corporation, 2001a (modified); National Imagery and Mapping Agency, 2002.

**EXPLANATION**

- Ground-Based Interceptor (GBI) Trajectory
  - Target Trajectory
  - 11 ft-lb Injury Debris
  - 1 Gram GBI Missile Debris
  - 1 Gram Target Missile Debris
  - Special Use Airspace
  - High Altitude Jet Routes
  - ⊗ Intercept Point
- Note: 76 ft-lb Debris is Contained Within the Area Shown as 11 ft-lb Debris

**Scenario 6: Sea Launch Target, Intercepted from Kodiak Launch Complex**

Pacific Ocean

**Figure 2.1.8-6**



Not to Scale

tests that could be conducted as a part of this Proposed Action; they are not meant to be inclusive or exclusive of other testing possibilities or launch trajectories.

The footprints displayed for debris represent the area within which all pieces of debris equal to or larger than 1 gram (0.04 ounce), 1.43 kilogram-meters (11 foot-pounds), and 9.9 kilogram-meters (76 foot-pounds) would fall. The 1-gram debris is the minimum for potential impacts to aircraft; 1.43 kilogram-meters (11 foot-pounds) is the lower limit for personnel injury; and 9.9 kilogram-meters (76 foot-pounds) is the level for personnel fatality (Range Commanders Council, Range Safety Group, 2002). If the interceptor misses the target it would burn up upon reentry. The target reentry vehicle would continue on its trajectory and land in the open waters of the Pacific Ocean. The appropriate Range Safety Officer would review test scenarios to ensure the interceptor kill vehicle and target reentry vehicle would not impact land areas should they miss.

## **2.2 NO ACTION ALTERNATIVE**

Under the No Action Alternative, the GMD ETR would not be established, and interceptor and target launch scenarios would not be fully tested under operationally realistic conditions. All existing launch areas and other support facilities would continue current operations for GMD and other mission activities as described in the following paragraphs. Use of mobile GMD test elements is also described.

### **2.2.1 LAUNCH SITES AND OTHER SUPPORT FACILITIES**

#### **Kodiak Launch Complex**

In defining the No Action Alternative at KLC, there are two decision points to be made by two different agencies (MDA and FAA); thus, there are two possible No Action Alternatives for this location.

The first is the MDA's No Action Alternative, in which the GMD ETR would not be established. For KLC, this would result in a continuation of the status quo through September 2003 with up to nine launches occurring per year from the facility. The current launch site operator license for KLC expires in September 2003. At that time, it is possible that the FAA would renew the KLC launch site operator license to continue launch operations. Under the new KLC license, it would be possible for the MDA to conduct launches that meet the conditions of the KLC license. Selection of the MDA's No Action Alternative would not preclude launches from the KLC. However, the activities associated with the ETR would not be conducted as described in this EIS.

If the FAA renews the launch site operator license for KLC, the AADC would continue launching various commercial and military launch vehicles from KLC. As shown in figure 2.1.2-1, several launch vehicles have been proposed for use and several others have already been launched from KLC. These launch vehicles are similar in size or larger than those included in the Proposed Action, and have similar potential environmental impacts. The Strategic Target System missiles launched from KLC would support GMD testing.

Under the second No Action Alternative by the FAA, the AADC's launch site operator license, which permits them to operate KLC for the purposes of conducting launches, would not be renewed. In the absence of any other arrangement, launch activities at KLC would be discontinued. The AADC currently holds a 30-year renewable Interagency Land Management

Assignment from the Alaska Department of Natural Resources. If launch activity were discontinued at KLC, AADC would coordinate with the state to determine a proposed future use for the land. It is possible that the facilities and equipment at the site would be used for other government purposes or handled as government surplus (e.g., sold) as described in the FAA's 1996 EA for KLC.

The lands on Kodiak Island at Narrow Cape have previously been considered for other development activities, such as prisons, schools, and other facilities. The site is located on one of the few improved roads on the island, and would be available for development for other purposes if AADC were no longer licensed to conduct launches.

For purposes of the analysis in this EIS, the FAA's No Action Alternative covers only the discontinued use of KLC, and does not specifically include any decommissioning or remediation activities that may be associated with the discontinued use of the facility.

### **Midway**

No GMD-related test activities would be conducted at Midway.

### **RTS**

RTS supports testing for a variety of ballistic missiles and sensor test activities. Missile flight test activities would continue at RTS, and GMD would continue to use the Meck Island launch complex for single and dual launches of GMD missiles, including GBI missiles. The existing range radars, including the GBR-P, and the existing IDT would continue to provide GMD missile test program support.

Previous environmental documents have analyzed potential impacts and mitigations associated with launching 12 to 28 strategic missiles per year from Meck. Other missile defense test programs at RTS may include the Theater High Altitude Area Defense (THAAD) missile system.

### **PMRF**

PMRF supports a wide variety of Fleet Training, Land-Based Training, and Test and Evaluation Activities. Fleet Training includes missile operations, air operations, gunnery, bombing, mining, electronic warfare, undersea warfare, and submarine operations. Land-based training includes solid and liquid propellant aerial target and missile launches, electronic warfare and countermeasures, radar, optical, telemetry, and communication systems operations, and troop exercises. Test and Evaluation activities include torpedo, torpedo defense, submarine and periscope detection, submarine systems, anti-submarine warfare, ship-defense systems, and land sensors.

Based on previous environmental analysis and current agreements, the Strategic Target System missile could be launched up to four times per year to support GMD or other missile test related programs. Additional missile tests at PMRF may include the THAAD missile system, Sea-Based Midcourse Defense, and various Fleet Training exercises such as the Rim of the Pacific exercise.

## **Vandenberg AFB**

Vandenberg AFB typically supports approximately five Minuteman or Peacekeeper launches per year from northern Vandenberg AFB launch sites. Based on previous environmental studies and a Letter of Authorization with the National Marine Fisheries Service, up to 10 Minuteman and Peacekeeper launches per year could occur from northern Vandenberg AFB launch sites. GMD target missiles and GBI booster verification missiles would be included in this number. Approximately three GMD target launches and two GBI booster verification launches would occur per year from north Vandenberg AFB. However, GBI booster verification launches would not include intercepts of target missiles over the ocean.

## **Eareckson Air Station**

Existing IDT, MILSATCOM, and the Cobra Dane Early Warning Radar would continue to be utilized at Eareckson Air Station.

## **2.2.2 MOBILE GMD SYSTEM ELEMENTS**

### **Mobile Telemetry and Radar**

Mobile telemetry and C-band radar would continue to be used as required to support target missile launches from KLC.

### **TPS-X Radar**

The TPS-X radar would continue to operate at either RTS or Vandenberg AFB in support of ongoing MDA test activities.

### **AN/SPY-1 Radar**

The AN/SPY-1 radar, although designed primarily for the Anti-Air Warfare mission, has been modified to perform ballistic missile detection and tracking as part of its new capability to perform Theater Ballistic Missile Defense. The Aegis ship would be positioned at various locations in the Pacific to provide missile tracking support during various MDA test activities.

### **Cobra Judy**

Observation Island (Cobra Judy) is a U.S. Air Force shipboard phased array radar system. Cobra Judy would continue to operate in support of ongoing MDA test activities.

### **SBX**

The SBX would not be built and operated in support of the GMD ETR. Initial testing of the SBX in the Gulf of Mexico would not occur, nor would there be a need for a port facility in the Pacific Region to support the SBX.

## **2.3 PROPOSED ACTION**

This section describes the locations and components necessary for implementing each of the Proposed Action alternatives listed in table 2.0-1. Each alternative includes the components described in section 2.1 located at various sites that provide maximum test effectiveness. For analysis purposes in this EIS, three alternative test architectures have been identified based on



developing additional interceptor launch capability at (1) KLC, (2) Vandenberg AFB, and (3) both KLC and Vandenberg AFB. Each alternative test architecture would include common GMD test components consisting of GBIs, target missiles, IDTs, the SBX, and other sensors and instrumentation.

### **2.3.1 ALTERNATIVE 1**

Alternative 1 includes the following components and locations:

- Single and dual GBI launches from KLC and RTS
- Single and dual target launches from KLC, Vandenberg AFB, and RTS
- Single target launches from the PMRF
- Target launches from mobile sea or air platforms
- Construction of two GBI silos or one GBI launch pad, and an additional target launch pad that could accommodate GBI launches if needed, and associated support facilities at KLC
- Target pad modifications at KLC and RTS
- COMSATCOMs at KLC, Midway, and/or sea-based
- Site preparation and operation of TPS-X radar at KLC or PMRF, or use of existing TPS-X at RTS or Vandenberg AFB
- Construction of an IDT at KLC, Midway, and/or sea-based
- Placement of small mobile telemetry units and mobile C-band radar at KLC and at one or two of the following locations: Pasagshak Point, Kenai, Homer, Soldotna, King Salmon, Adak, Cordova, and Pillar Mountain, Alaska; Pillar Point, California; Bremerton, Washington; Makaha Ridge and PMRF, Hawaii; Midway; and Wake
- SBX construction, Primary Support Base, and operation

#### **2.3.1.1 Kodiak Launch Complex and Vicinity**

As part of Alternative 1, the proposed GMD infrastructure for launching targets and interceptors would consist of the following:

- Two GBI launch sites, supporting facilities, and ancillary equipment to host two sets of Command Launch Equipment and all utilities and facilities to support operations
- Two target launch pads, supporting utilities, and infrastructure
- A Missile Assembly Building
- A Movable Missile Building
- Addition to the planned AADC Maintenance and Storage Facility
- Addition to the Launch Control Center
- Missile Storage Facility
- An IDT facility
- COMSATCOM equipment
- A new mancamp to support construction and operational personnel

- TPS-X radar
- An addition to the existing Narrow Cape Lodge adjacent to KLC
- Barge landing for large GBI components—adjacent to KLC

It is anticipated that the GBI and Target related construction periods would not occur at the same time.

### Existing and Proposed Launch Support Structures

Existing facilities to be used, and in some cases modified, by GMD are listed in table 2.3.1-1. Proposed new facilities to support GMD are listed in table 2.3.1-2. The approximate area that would be affected during construction of the various components and facilities is listed in table 2.3.1-3. As shown in table 2.3.1-3, GBI related facilities include GBI access roads, GBI fenced area, GBI silos/Launch Pad, Mechanical/Electrical Building, Oxidizer Storage Building and road, entry control buildings, Maintenance Storage Building addition, Launch Control Center addition, existing lodge expansion, and a new mancamp. Construction for GBI-related components would require approximately 100 personnel for 12 to 15 months. Target-related facilities include target access roads, target launch pad, Movable Missile Building, Missile Assembly Building, Motor Storage Building and access road, existing lodge expansion, and a new mancamp. Construction for target-related facilities would require approximately 100 personnel for 12 to 15 months. Construction of the IDT would require approximately 35 personnel for 6 months.

**Table 2.3.1-1: Alternative 1—Existing Facilities to be Used and/or Modified for Ground-Based Midcourse Defense at Kodiak Launch Complex and Vicinity**

Existing Facility	Quantity	Characteristics
Launch Control Center	1	53.3 meters (175 feet) long, 24.4 meters (80 feet) wide, and 12.2 meters (40 feet) high; 100-person occupancy during launches
Payload Processing Facility—potential minor modifications	1	Includes a clean room high bay and processing bay
Spacecraft Assembly and Transfer Building—no modifications	1	An environmentally conditioned mobile structure used to transfer the launch vehicle stages from the Integration and Processing Facility to Launch Pad 1
Integration and Processing Facility—no major modifications	1	Includes a high bay
Target Launch Pad and Launch Service Structure (LSS)—minor modifications to the LSS	1	Launch Pad 1 consists of the pad and apron, a flame duct, launch equipment vault, and an LSS. The LSS allows for environmental protection and access to the launch vehicle for final assembly and check out in the vertical position.
Planned Maintenance and Storage Facility	1	Planned AADC maintenance and storage facility to be completed by 2004
Planned Gravel Pad for Antenna Array	1	To be completed by 2004, approximately 8,083 square meters (87,000 square feet)
COMSATCOM—no modifications	1	Existing satellite communications facility
Hypergolic Fuel Storage Facility—no modifications	1	Storage of liquid fuel
Barge Landing Site 1	1	Site previously used to bring in the Narrow Cape Lodge; no construction of structures
Construction Laydown Areas—no modifications	2	Previously disturbed areas for construction equipment

**Table 2.3.1-2: Alternative 1—Proposed New Facilities for Ground-Based Midcourse Defense at Kodiak Launch Complex**

<b>Proposed Facility</b>	<b>Quantity</b>	<b>Characteristics</b>
GBI silo	2	Each silo is approximately 3 meters (10 feet) across, 21 meters (70 feet) deep, and they are located approximately 70 meters (230 feet) apart
GBI Mechanical Electrical Building	1	Approximately 5 meters (16.4 feet) by 5 meters (16.4 feet)
GBI Launch Pad	1	Potential option for pad launch of GBI if silos are not constructed; pad would be constructed in same location as proposed silos, or could be constructed as part of the proposed new target launch pad site
Missile Assembly Building	1	Approximately 15 meters (50 feet) wide, 30 meters (100 feet) long, and 18 meters (60 feet) high
Movable Missile Building	1	Approximately 12 meters (40 feet) wide, 21 meters (70 feet) long, and 33.5 meters (110 feet) high, and it would have doors at both ends of the structure
Missile Storage Facility and access road	1	Approximately 30.5 meters (100 feet) wide, by 38.1 meters (125 feet) long, by 5.5 meters (18 feet) high
New Target Launch Pad (may be used for GBI)	1	Approximately 53.3 meters (175 feet) by 53.3 meters (175 feet)
Oxidizer Storage Facility	1	Similar to the existing hypergolic fuel storage facility. Approximately 5 meters (16.4 feet) by 5 meters (16.4 feet)
Mancamp	1	Approximately 50 meters (164 feet) wide, 90 meters (295 feet) long, and 10 meters (33 feet) high, with the capacity to house approximately 60 personnel
Addition to existing Narrow Cape Lodge	1	Approximately same size as mancamp proposed on KLC
Addition to the planned KLC Maintenance and Storage Facility—add 1,394 square meters (15,000 square feet)	1	Addition to the planned AADC maintenance and storage facility
Addition to the Launch Control Center—add 464.5 square meters (5,000 square feet)	1	Addition to the existing Launch Control Center
IDT	1	Approximately 30.7 meters by 11.6 meters (101 feet by 38 feet) and would have a 5.5-meter (18-foot) diameter radome mounted on one end of the building
TPS-X Radar	1	Requires gravel pad area of approximately 0.3 hectare (0.8 acre)
COMSATCOM	1	Similar to existing COMSATCOM
Entry control	1	Approximately 5 meters (16.4 feet) by 5 meters (16.4 feet)
Barge landing sites 2 and 3	2	Alternative locations for barge landing; no construction of structures

**Table 2.3.1-3: Alternative 1—Potential Ground Disturbance for Ground-Based Midcourse Defense at Kodiak Launch Complex**

Primary Component	Hectares (Acres)	Associated Facilities
GBI Associated Construction (12-15 months)	14.4 (35.5)	GBI access roads, GBI fenced area, GBI silos/Launch Pad, Mechanical/Electrical Building, Oxidizer Storage Building and road, entry control buildings, Maintenance Storage Building addition, Launch Control Center addition, existing lodge expansion, new mancamp
IDT in Fenced Area (6 months)	5.9 (14.6)	IDT area and road is included
COMSATCOM Fenced Area (1 month)	2.8 (7.0)	COMSATCOM area is 0.1 hectare (0.2 acre); remainder is cleared area with possible disturbance
Mobile Telemetry/Mobile C-Band Radar	0.6 (1.4)	Gravel pad
TPS-X Radar (1 month)	0.3 (0.8)	Gravel pad, same location as IDT site south of Loran C Station
Target Associated Construction (12-15 months)	10.5 (26.0)	Target access roads, target launch pad, Movable Missile Building, Missile Assembly Building, Motor Storage Building and access road, existing lodge expansion, new mancamp

Since either GBI-related facilities or target-related facilities, or both, could be constructed at KLC, the areas are listed separately for each related facility. If both GBI- and target-related facilities are constructed, there would be an overlap of approximately 8.5 hectares (21 acres). Considering the overlap, the total potential disturbed area for GBI, target, IDT, COMSATCOM, mobile telemetry, TPS-X, and associated facilities would be approximately 26 hectares (64.2 acres).

The locations of the existing and proposed facilities are shown in figures 2.3.1-1 through 2.3.1-4.

### **Proposed Facilities**

#### *New GBI Silos*



New GBI silos or a launch pad would be required at KLC. The silos are approximately 3 meters (10 feet) in diameter and 21 meters (70 feet) long (deep). The pad, if required, would be approximately 53.3 by 53.3 meters (175 by 175 feet). A Mechanical/Electrical Building would be constructed adjacent to the silos.

#### *New Target Launch Pad*

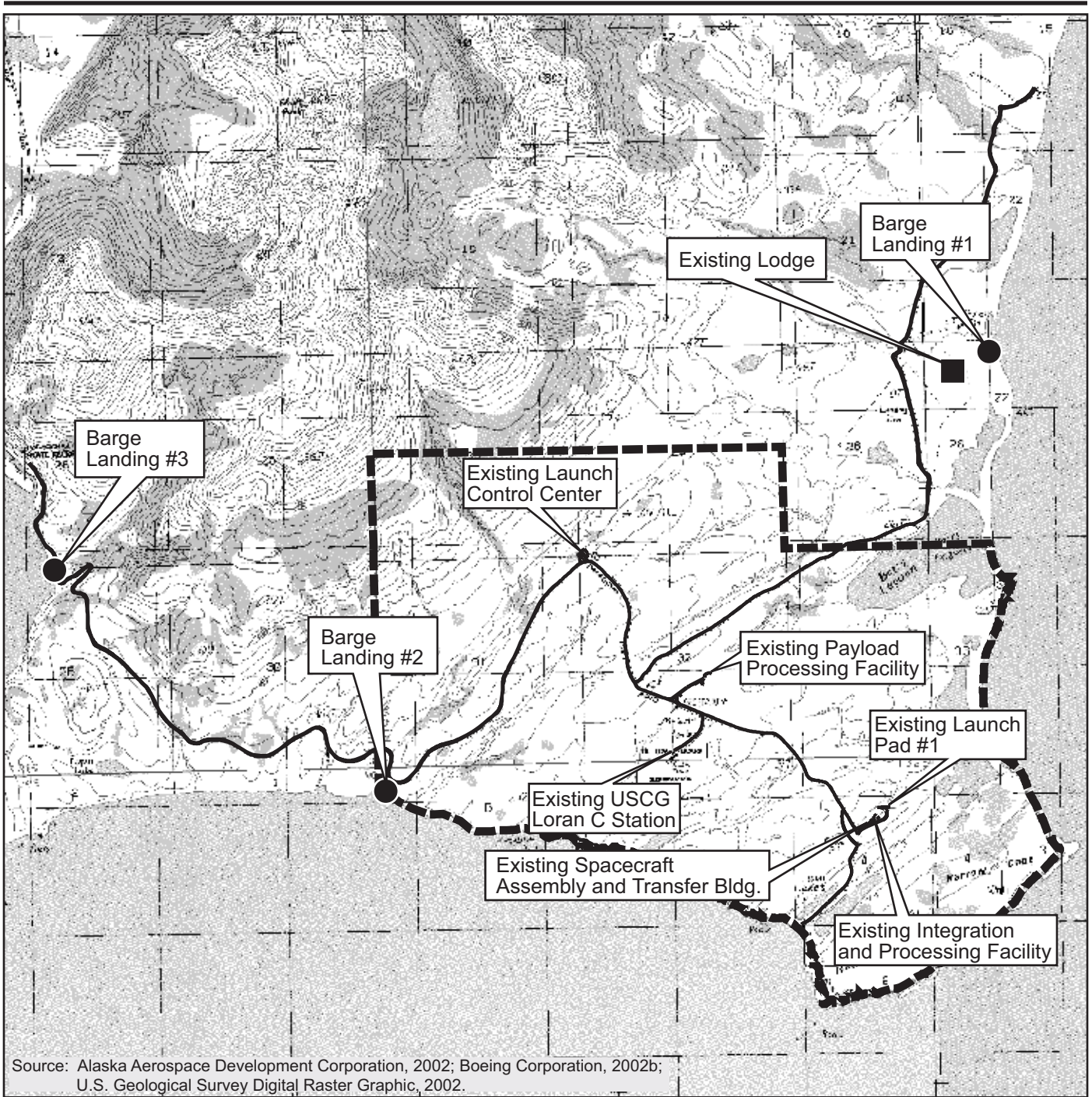
A new launch pad would be constructed to meet design specifications for the launch of target missiles. The pad could also support GBI missiles, although additional equipment would be required. The pad would be approximately 53.3 meters (175 feet) by 53.3 meters (175 feet).



**EXPLANATION**

-  Kodiak Launch Complex Installation Boundary
-  Roads
-  Barge Landing Points

USCG = United States Coast Guard

**Existing Facilities and Proposed Barge Landing Sites**

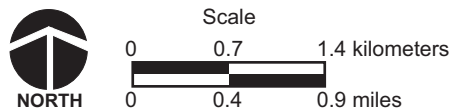

Kodiak Island, Alaska

**Figure 2.3.1-1**

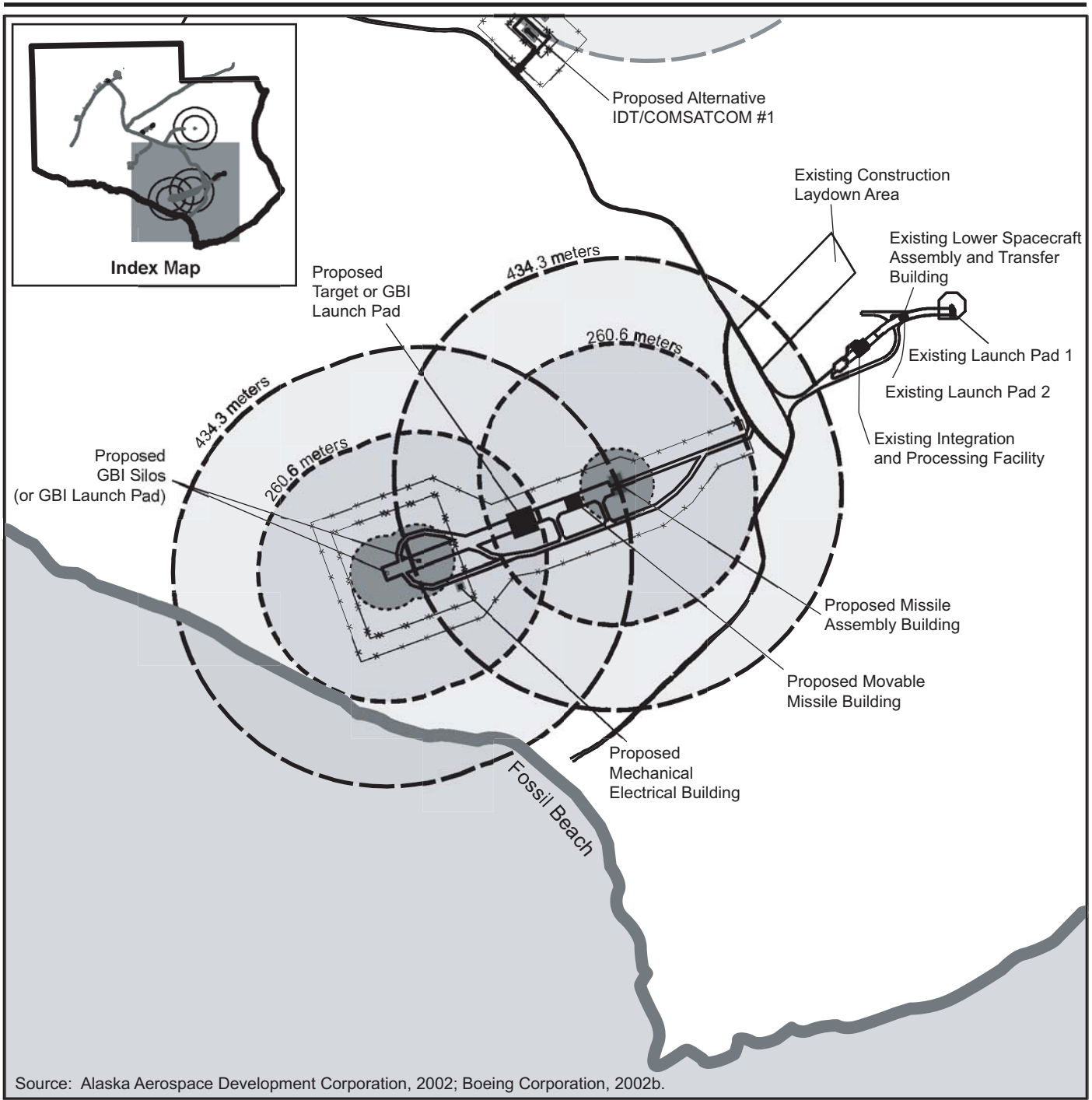

Source: Alaska Aerospace Development Corporation, 2002; Boeing Corporation, 2002b.

**EXPLANATION**

- Transportation ESQD (1.1) 260.6 meters (855 feet)
- Inhabited Building ESQD (1.1) 434.3 meters (1,425 feet)
- Inhabited Building and Transportation ESQD (1.3) 74.6 meters (245 feet)
- Water
- Roads

- GBI = Ground Based Interceptor
- IDT = In-flight Interceptor Communication System Data Terminal
- COMSATCOM = Commercial Satellite Communications
- TPS-X = Transportable System Radar
- Installation Boundary

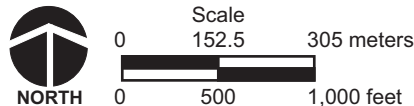

**Existing KLC and Proposed GMD Facilities Layout in South Kodiak Launch Complex**

**Figure 2.3.1-2**

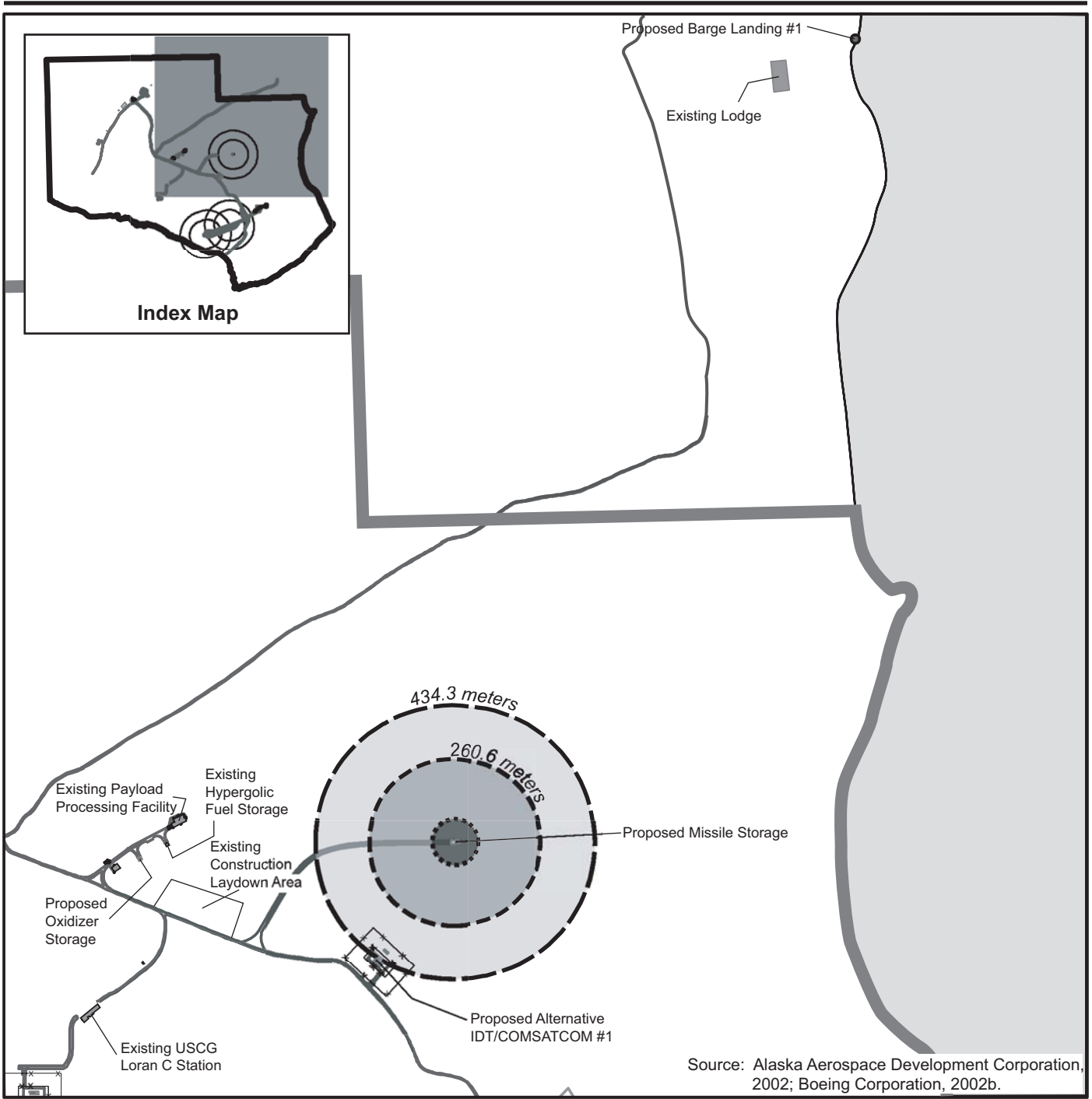

**EXPLANATION**

- Transportation ESQD (1.1) 260.6 meters (855 feet)
- Inhabited Buildings ESQD (1.1) 434.3 meters (1,425 feet)
- Inhabited Buildings ESQD (1.1) 74.6 meters (245 feet)
- Water
- Roads
- NORTH
- Scale  
0 241 482 meters  
0 791.5 1,583 feet
- IDT = In-flight Interceptor Communication System Data Terminal
- COMSATCOM = Commercial Satellite Communications
- USCG = United States Coast Guard
- TPS-X = Transportable System Radar
- Installation Boundary

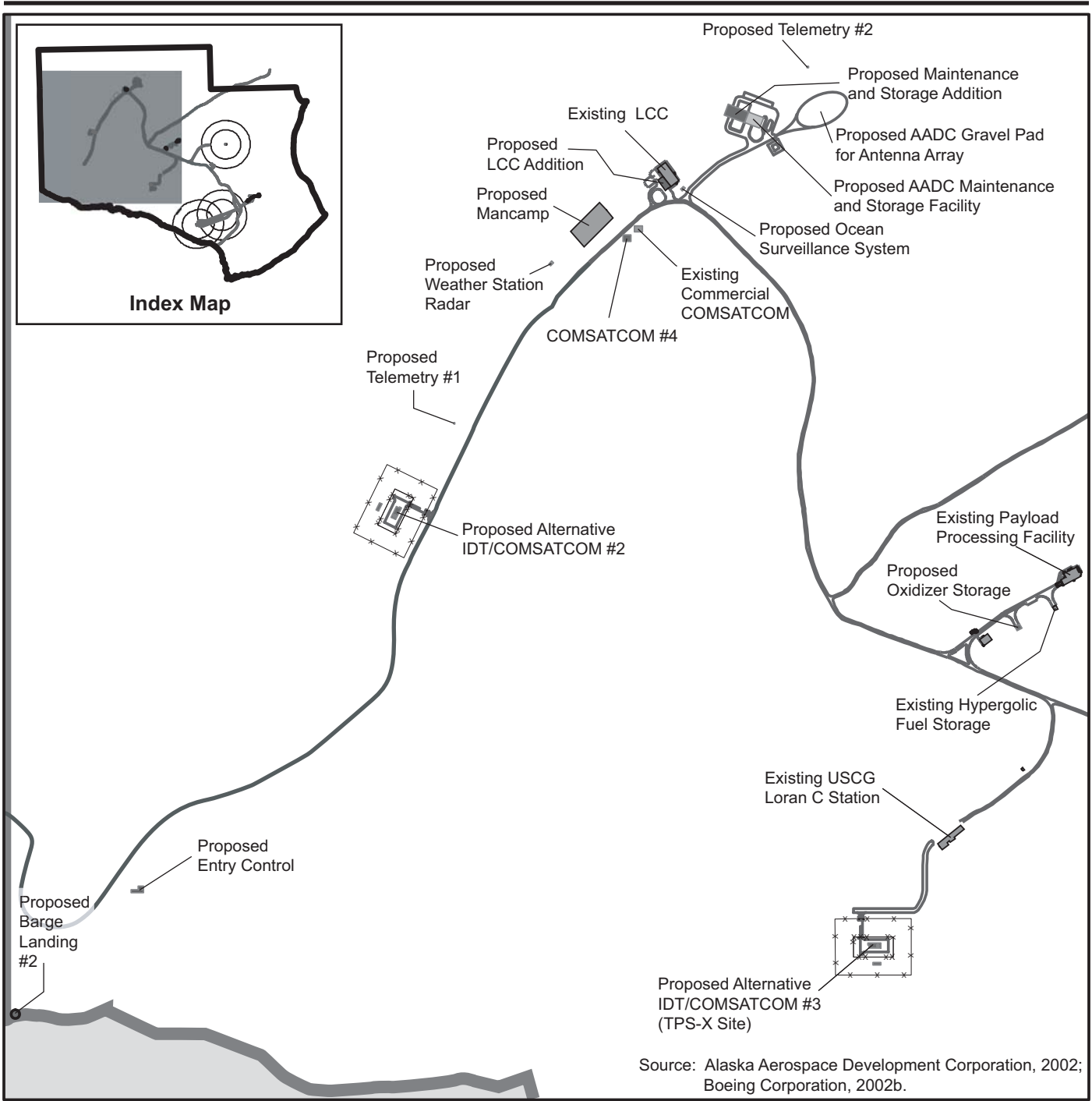

**Existing KLC and Proposed GMD Facilities Layout in Northeast Kodiak Launch Complex**

**Figure 2.3.1-3**



Source: Alaska Aerospace Development Corporation, 2002; Boeing Corporation, 2002b.

**EXPLANATION**

-  Water
-  Roads
-  Installation Boundary

- IDT = In-flight Interceptor Communication System Data Terminal
- COMSATCOM = Commercial Satellite Communications
- LCC = Launch Control Center
- AADC = Alaska Aerospace Development Corporation
- USCG = United States Coast Guard
- TPS-X = Transportable System Radar

**Existing KLC and Proposed GMD Facilities Layout in Northwest Kodiak Launch Complex**

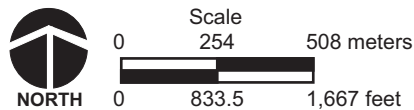

**Figure 2.3.1-4**



### *New Missile Assembly Building*

Although the current plans include use of the existing Integration and Processing Facility for missile assembly activities, the construction of an additional Missile Assembly Building will be evaluated in the EIS. The proposed Missile Assembly Building would be the location for processing launch vehicles and, for some configurations, mating of payloads to launch vehicles. The facility would be about 15 meters (50 feet) wide, 30 meters (100 feet) long, and 18 meters (60 feet) high, covering an area of 460 square meters (5,000 square feet). Exterior features would include the following:

- Paved access road and parking for staff vehicles and tractor trailers
- A paging and area warning system
- Wall-mounted sodium-vapor lighting
- Aircraft obstruction lighting
- A 500-kW diesel generator (maximum 146 liters [39.3 gallons] of fuel per hour)
- A 9,500-liter (2,500-gallon) storage tank for Number 2 diesel fuel
- A 59-square-meter (625-square-foot), 1.8-meter-high (6-foot-high) mounded absorption bed (buried 4,700-liter [1,250-gallon] septic tank)

The interior of the proposed Missile Assembly Building would contain a large, central working area with an overhead crane and a peripheral entry room, restroom, utility rooms, and an equipment airlock. Portable detectors would be used to monitor for hazardous vapors. Depending on the type of launch vehicle involved, fairing-enclosed payloads would be connected to the launch vehicles, and multi-stage launch vehicles inter-connected, in a horizontal position on carts. The integrated assemblies would be electronically tested. The facility would be designed for a 20-person capacity. Peak water demand and sanitary discharge would be approximately 2,400 liters (650 gallons) per day. The proposed Missile Assembly Building would be similar to the existing Integration and Processing Facility shown in figure 2.3.1-5.

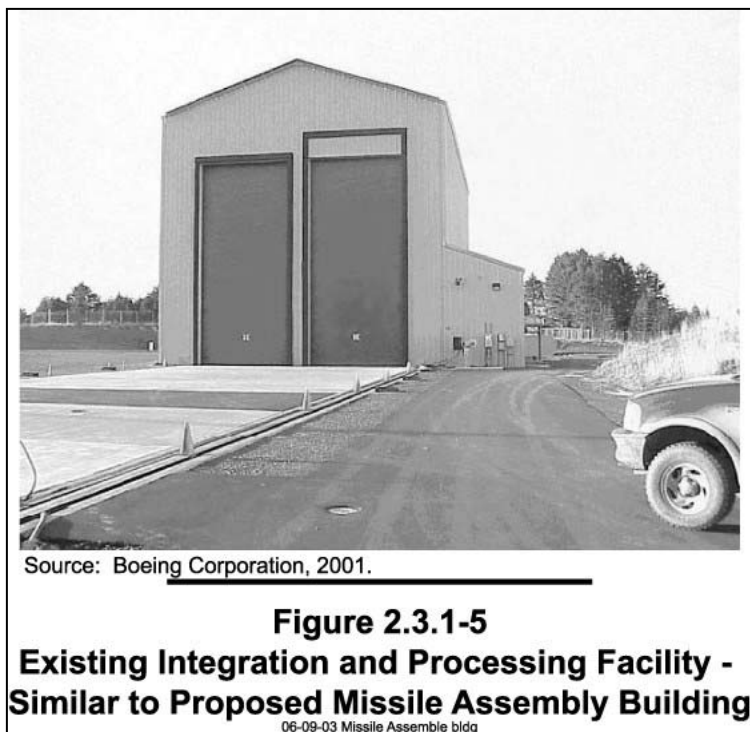

### *New Movable Missile Building*

The proposed Movable Missile Building (figure 2.3.1-6) would be a mobile structure used to enclose missile assemblies for transfer to the launch pad. The new facility would be approximately 12 meters (40 feet) wide, 21 meters (70 feet) long, and 33.5 meters (110 feet) high, and it would have doors at both ends of the structure. The structure would be mounted on rollers on steel rails imbedded in concrete foundations. The assemblies would be wheeled on carts out of the Missile Assembly Building and into the Movable Missile Building through abutting doorways.

Detectors would be used to monitor for hazardous vapors. After closing doors and securing carts, a tractor would move the Movable Missile Building with target missile to the target launch pad or over the GBI silos or pad.



Once at the target launch pad, the target launch vehicle and payload would be lifted from the horizontal to the vertical position (figure 2.3.1-7) and would be enclosed in the Movable Missile Building until the time of launch, at which time the building would be moved away. External features would include the following:

- A 53-meter (175-foot) square concrete pad
- Steel-lined concrete ductwork to deflect launch-exhaust flame and accompanying noise toward the north
- A paging and a warning system
- Wall mounted sodium-vapor lighting
- Rail system between the new Missile Assembly Building and GBI silos or launch pads
- Aircraft obstruction lighting

Internal features would include vertically adjustable platforms for accessing various levels of the target missile and payload, a crane, clean work areas, utility rooms, and communications umbilicals to link the target missile to the Launch Control Center. Emergency power would be supplied from the Missile Assembly Building, and uninterruptible-power-supply batteries would serve critical loads. Portable detectors would be used to monitor for hazardous vapors.

### *Missile Storage Facility*

The Missile Storage Facility would be approximately 30.5 meters (100 feet) wide, by 38.1 meters (125 feet) long, by 5.5 meters (18 feet) high. The Missile Storage Facility would have a perimeter fence.

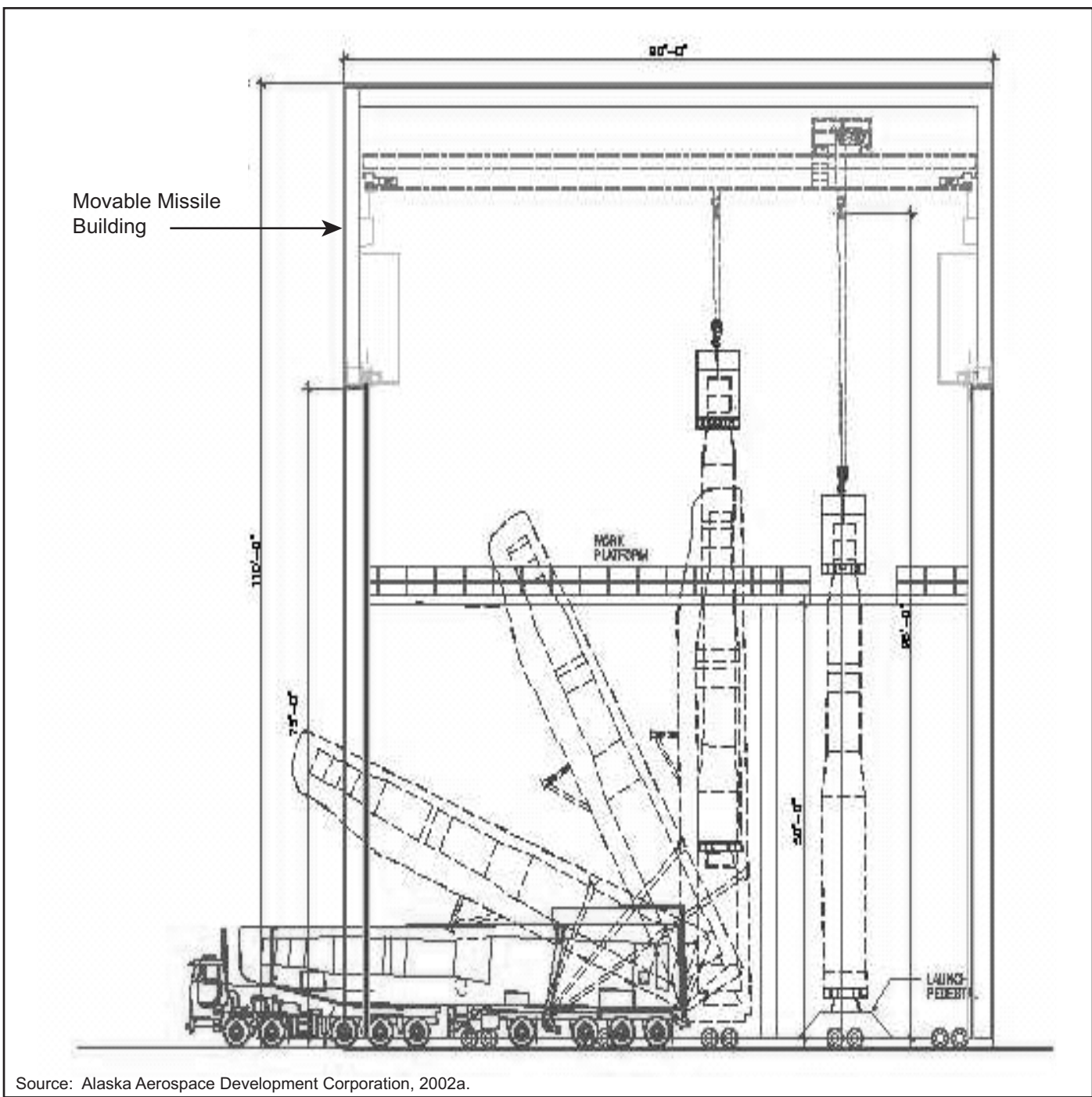

**Target Missile at Launch Pad**

Not to Scale

**Figure 2.3.1-7**

### *Oxidizer Storage Facility*

An oxidizer storage building would be constructed in the vicinity of the existing hypergolic fuel storage building. The building would be approximately 5 meters (16.4 feet) by 5 meters (16.4 feet) with a security fence similar to the fence at the hypergolic fuel storage facility.

### *Mancamp*

The proposed mancamp would be located on KLC property to the west of the Launch Control Center to house construction and operational personnel. The building would be approximately 50 meters (164 feet) wide, 90 meters (295 feet) long, and 10 meters (35 feet) high, with the capacity to house approximately 60 personnel. The mancamp would have perimeter fence. An additional alternative is an addition to the existing Narrow Cape Lodge mancamp. This addition would be approximately the same size as the proposed mancamp.

### *Commercial Satellite Communications*

The COMSATCOM Earth Terminal (figure 2.1.3-2) requires a footprint of approximately 0.1 hectare (0.25 acre) to accommodate the Earth Terminal and equipment. Primary power is from a commercial source with backup power provided by generator. Communication cable to the launch control complex would be required. Equipment would be housed in a military van, a small building, or an existing adjacent facility if available. Security requirements for fencing increase desired acreage to approximately 2.8 hectares (7 acres). The minimal requirements include a concrete base for the Earth Terminal, an all-weather road to the site, and a prepared surface around the site at least 4.6 meters (15 feet) wide. KLC would require two COMSATCOMs for redundancy requirements. One existing COMSATCOM would be utilized and a new COMSATCOM would be constructed at one of the proposed IDT locations identified on figures 2.3.1-2, 2.3.1-3, and 2.3.1-4.

### *Communications Cable*

For communication among the components on the same installation, the ETR would maximize use of available communications assets, including cable. If communication cable is not available, new cable would be installed. Installation of new cable would be in existing conduit, if available. If not, new conduit would be constructed along rights-of-way. Where necessary, new conduit would require a route approximately 1 meter (3 feet) wide, buried to a depth of approximately 1 meter (3 feet) from the surface. A manhole and cover would be located approximately every 200 meters (600 feet) to allow access to the cables for maintenance and for future cable installations.

### *In-Flight Interceptor Communication System Data Terminal*

As described in section 2.1.3, the IDT could be a fixed or relocatable land-based unit. A fixed IDT would be contained in a building that is approximately 30.7 meters by 11.6 meters (101 feet by 38 feet) and would have a 5.5-meter (18-foot) diameter radome mounted on one end of the building (figure 2.1.3-1). The radome, which covers the antenna, would be inflatable. An external aboveground fuel tank would be located near the building. The mission backup power generator would be located adjacent to the IDT. This backup generator would be rated at 250 kW and would be housed in a 3.4- by 1.5-meter (11- by 5-foot) wide enclosure.

A relocatable IDT would require approximately the same area and have similar utilities requirements as a fixed IDT. Figures 2.3.1-2, 2.3.1-3, and 2.3.1-4 show the three alternative

sites for the IDT at KLC. Operations and security requirements would be as described in section 2.1.3.

#### *TPS-X Radar*

As described in section 2.1.5.2, the TPS-X radar is a transportable wide band, X-band, single faced, phased array radar system of modular design. The alternative site for IDT, located south of the existing Loran C Station, shown on figure 2.3.1-4, could also be used for the TPS-X radar. The TPS-X site would require 0.3 hectare (0.8 acre). The Prime Power Unit is a 1.5-MW generator that provides power to the radar during testing. Operation of the Prime Power Unit would require refueling operations. The fuel tank would be filled from a fuel truck, as necessary. Impermeable ground covering material and spill containment berms would be placed for containment of fuel during fueling operations. Spill control procedures that meet AADC's approved SPCC, and spill control kits would be present at the site in the unlikely event of a fuel leak or spill.

The Cooling Equipment Unit is a closed system, and no discharges of the ethylene glycol solution are planned. However, because of the remote potential for leaks or spills during system hook-up, or the possibility of ruptured hoses or accidental disconnection, impermeable ground cover would be in place as was described for the Prime Power Unit.

EMR hazard exclusion areas would be established around the TPS-X radar antenna. The personnel exclusion area would extend for 150 meters (492 feet) in front of the radar. The FAA would be requested to establish a navigation warning advising aircraft to remain at least 1,500 meters (4,900 feet) from the TPS-X radar site. EEDs in the presence and shipping phase, such as a missile mounted on an aircraft, would need to be at least 800 meters (2,625 feet) from the radar. EEDs in the handling phase would need to be at least 400 meters (1,312 feet) from the radar due to potential sidelobe exposure. Figure 2.3.1-8 depicts these potential TPS-X radar radiation interference areas.

#### **Launch Complex Security**

It is assumed that testing would be on a campaign basis and the security for these tests would be on a similar basis. It is estimated that the security activities would occur for approximately 5 weeks for each campaign.

Security force personnel would be present at KLC during each campaign. There would be one Security Operations Center, located in the addition to the Launch Control Center, which would be shared with the KLC security personnel. This building would house the central program protection activities for the site and all operations equipment. Lights would be installed outside the building.

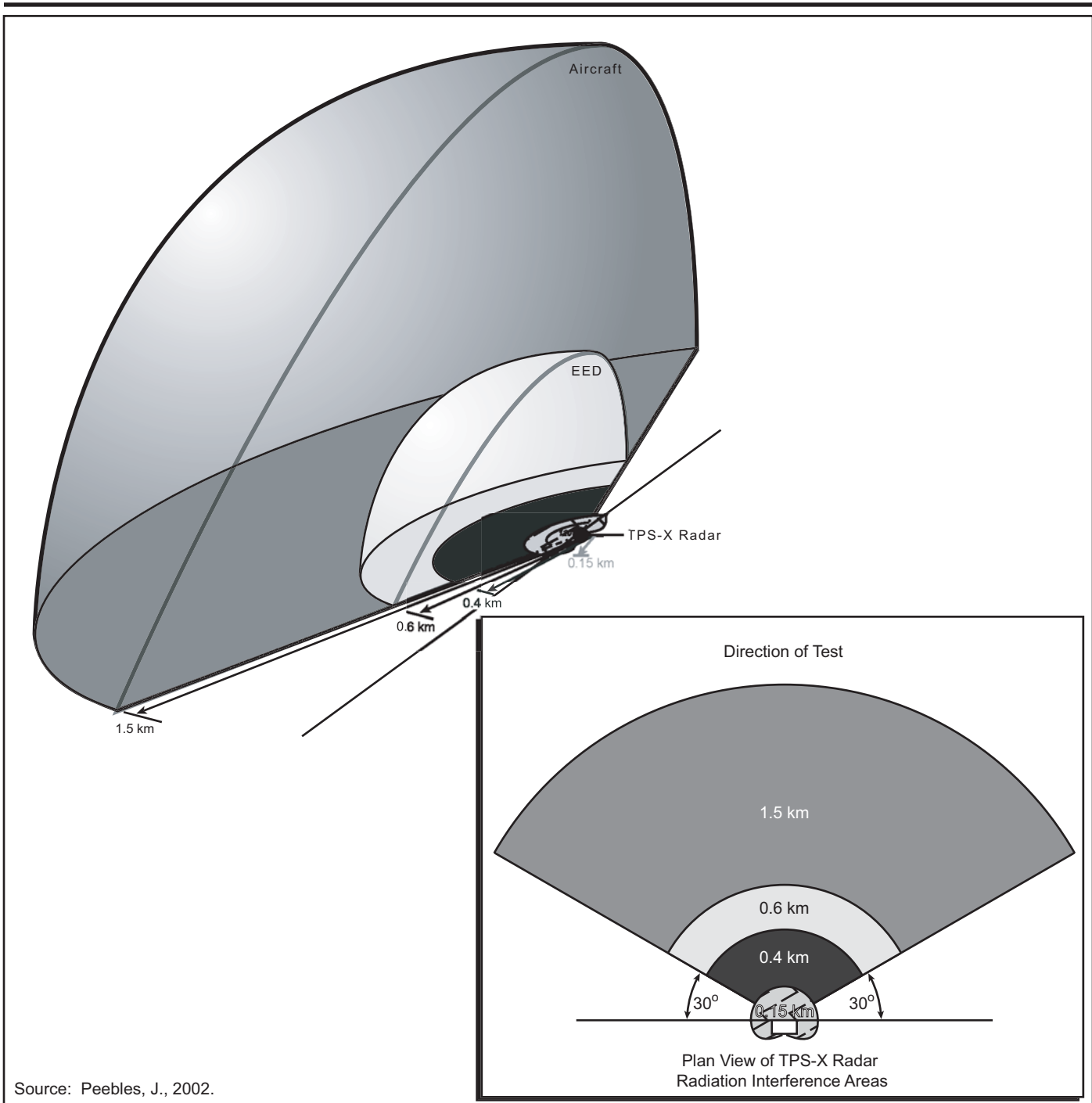

Source: Peebles, J., 2002.

### TPS-X Radar Radiation Interference Areas

**EXPLANATION**

- Aircraft - Main Beam Exposure
- EEDs in presence and shipping phase - (600 meter) - Main Beam Exposure
- EEDs in loading and handling phase - (400 meter) - Side Lobe Exposure
- Personnel - (150 meter) - Side Lobe Exposure

TPS-X = Transportable System Radar

Not to Scale

**Figure 2.3.1-8**

A parking area would be established at the building for patrol and private vehicles. Additional roads may be needed depending on the site chosen for the building. Additional buried telephone and power lines would also be required to the building.

Up to three Access Control Facilities may be required that include one to the entrance of KLC and two other locations. These may be mobile or permanent construction depending on their location and overall utility. Wherever located, each Access Control Facility would require power for internal and external lighting. Parking and one portable restroom would be required per Access Control Facility.

The existing Intrusion Detection System would be expanded to include all critical buildings associated with the GMD operations. This would include the installation of additional intrusion sensors, lighting, closed circuit television, and a monitor for the sensors. These systems are common and are used at other sites used by the GMD.

Additional physical protection features may be constructed or placed to protect GMD assets. These may include, but are not limited to, fences, security lighting, bollards, tapered concrete barriers or similar devices, ditching and/or earth mounds, patrol roads, and observation tower(s).

During the operational day, security vehicles would be on patrol. At night, there would be additional vehicles in use as needed. Each vehicle would have radio equipment that would be in operation while on patrol. Normal patrols would be confined to existing roads. There would be occasions when these vehicles would be expected to go off-road.

### **Public Access Limitation**

For safety reasons, the public would be denied access to KLC and the use of Fossil Beach for up to 1 day during any interceptor or target launch. It is anticipated that an Access Control Facility would be established at the entrance of KLC during a campaign to record vehicles entering and leaving the site. Additionally, beach access would be restricted for hours at a time during hazardous operations in accordance with the existing KLC safety plan. The beach could also be closed during times of heightened national security.

#### **2.3.1.2 Midway—In-Flight Interceptor Communication System Data Terminal and Commercial Satellite Communications**

Although Midway was an alternative site in the Draft EIS, MDA has determined that it is no longer a reasonable alternative and will not be a proposed site for ETR activities. The IDT on-board the SBX would perform the function that had been planned for Midway. The discussion of Midway has been retained in the Final EIS, however, in order to preserve the work that has already been performed. Under Alternative 1, an IDT and two COMSATCOMs, located in close proximity, would be required in a performance region located in the Pacific Ocean. Figure 2.3.1-9 provides the candidate IDT and COMSATCOM locations on Midway. Two of the potential sites include collocated telemetry, COMSATCOM, and IDT. There is also a third site that is COMSATCOM only. In addition, there is an existing COMSATCOM site that could be refurbished for GMD use.

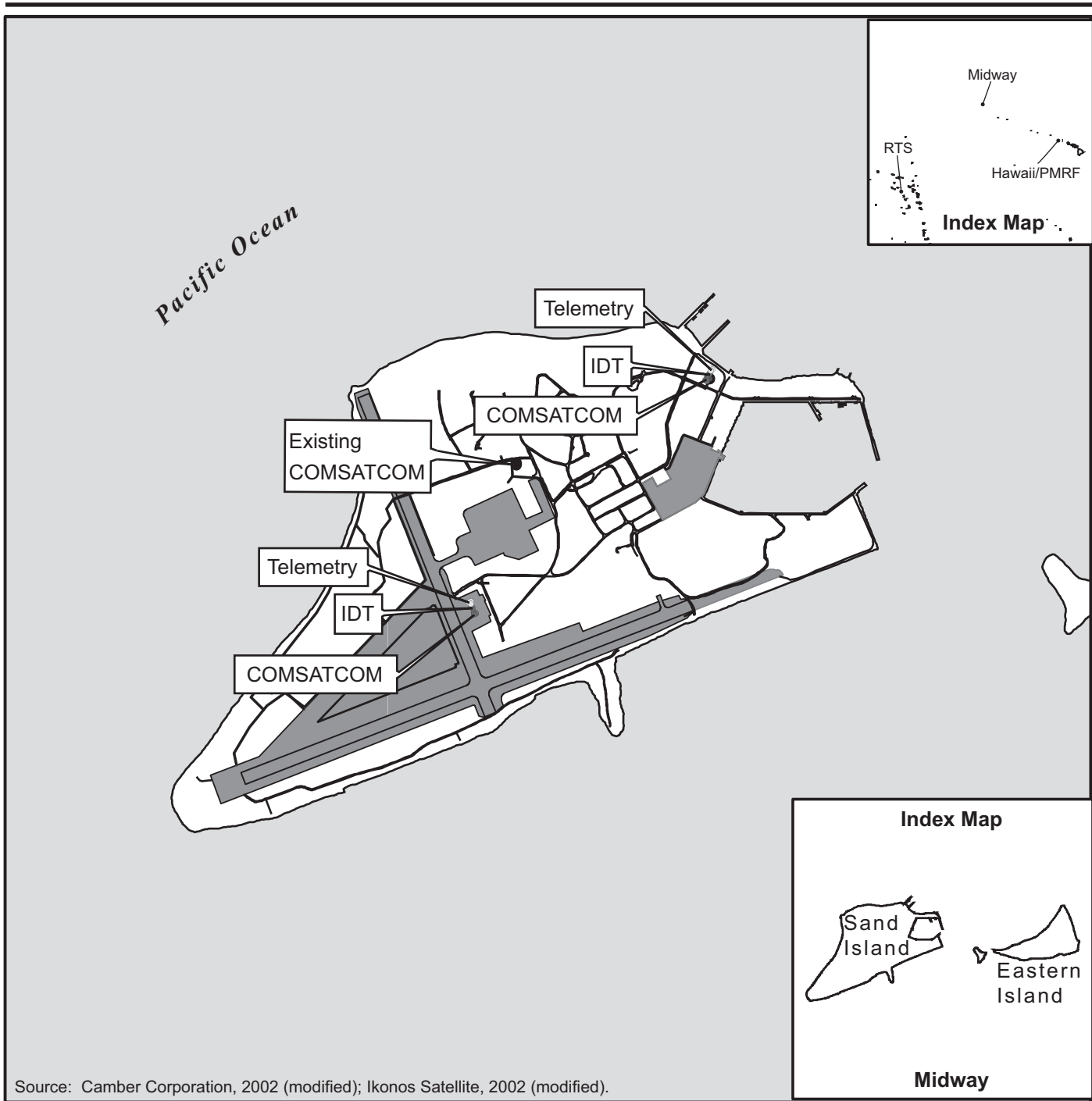

Source: Camber Corporation, 2002 (modified); Ikonos Satellite, 2002 (modified).

**EXPLANATION**

- Pacific Ocean
- Airfield
- Land
- Roads

IDT = In-flight Interceptor Communication System Data Terminal  
 COMSATCOM = Commercial Satellite Communications  
 RTS = Reagan Test Site  
 PMRF = Pacific Missile Range Facility

Note: Although Midway was an alternative site in the Draft EIS, MDA has determined that it is no longer a reasonable alternative and will not be a proposed site for ETR activities. The IDT on-board the SBX would perform the function that had been planned for Midway. The discussion of Midway has been retained in the Final EIS, however, in order to preserve the work that has already been performed.

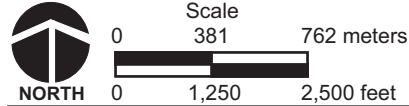

**Candidate IDT and COMSATCOM Locations**

Midway

**Figure 2.3.1-9**



As described in section 2.1.3, the IDT could be a fixed or relocatable land-based unit. A fixed IDT would be contained in a building that is approximately 30.7 meters by 11.6 meters (101 feet by 38 feet) and would have a 5.5-meter (18-foot) diameter radome mounted on one end of the building (figure 2.1.3-1). The radome, which covers the antenna, would be inflatable. An external aboveground fuel tank would be located near the building. The mission power generator would be located adjacent to the IDT. This generator would be rated at 250 kW and would be housed in a 3.4- by 1.5-meter (11- by 5-foot) wide enclosure. Dimensions are approximations only.

The COMSATCOM Earth Terminal (see figure 2.1.3-2) requires a footprint of approximately 0.1 hectare (0.25 acre) to accommodate the Earth Terminal and equipment. Primary power would be from the existing Midway power supply with backup power provided by generator. Equipment would be housed in a military van, a small building, or an existing adjacent facility if available. Security requirements for fencing include approximately 2.8 hectares (7 acres). The site requirements include a concrete base for the Earth Terminal, an all-weather road to the site, and a prepared surface around the site at least 4.6 meters (15 feet) wide.

Construction of the IDT and COMSATCOM would require approximately 35 personnel for a period of 6 months.

### **2.3.1.3 Ronald Reagan Ballistic Missile Defense Test Site**

Under Alternative 1 the RTS would continue to be a launch site for GBIs. The following activities would continue at RTS:

- Launch of GBIs from Meck and use of existing IDT on Kwajalein
- Use of extensive range instrumentation
- Use of the GBR-P ground-based XBR
- Missile intercepts in the Broad Ocean Areas (BOAs) north and northeast of RTS

The existing Payload Launch Vehicle GBI silo could be modified to provide the capability to launch target missiles. The candidate GMD locations at Meck Island are shown on figure 2.3.1-10.



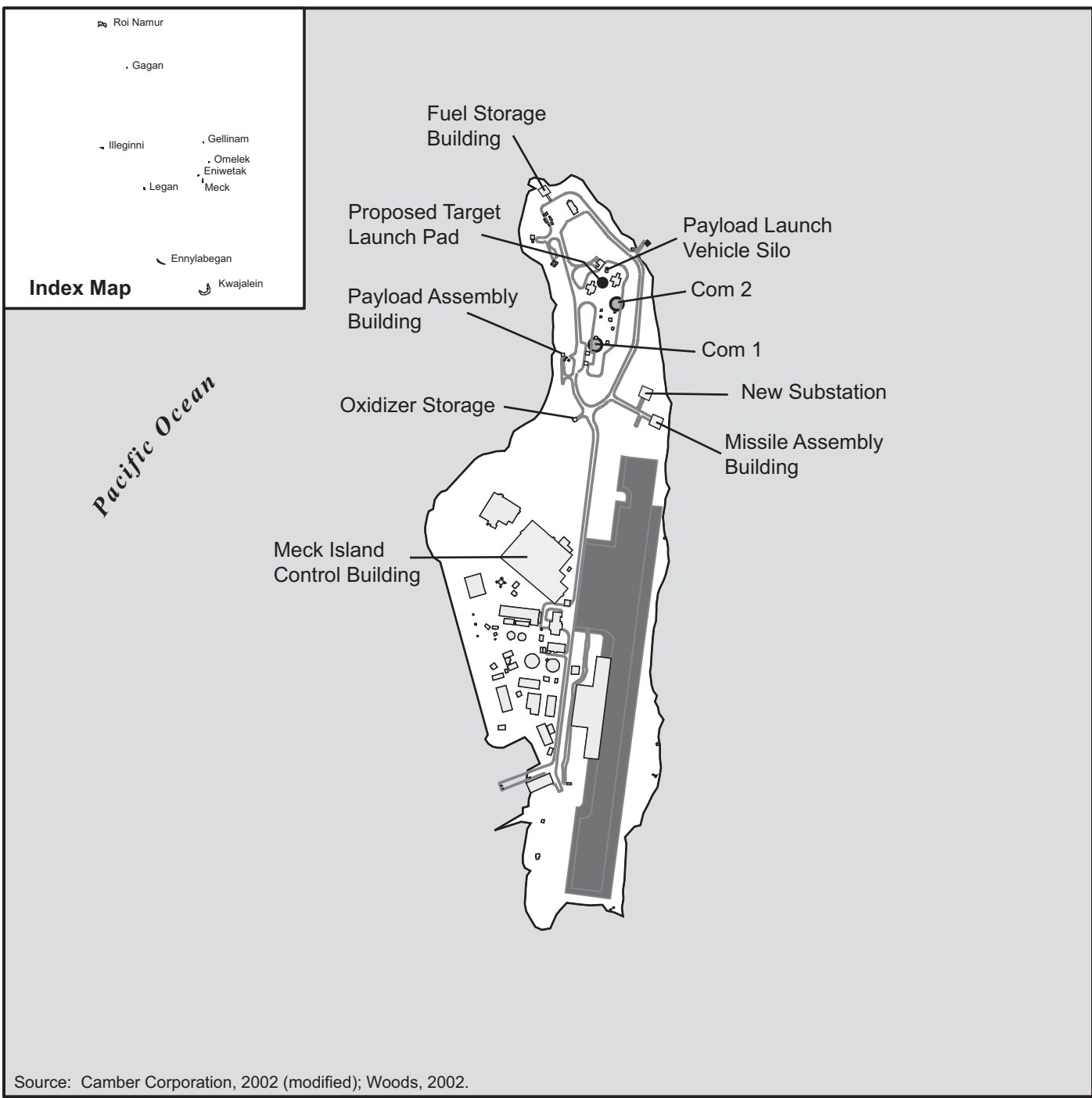

RTS is also a potential PSB location for the SBX. Although the piers at the RTS harbor do not offer adequate depth to accommodate the draft of the SBX, the vessel can enter the Kwajalein Lagoon and moor in a protected anchorage. A dedicated resupply vessel would not be required as RTS has a full complement of supply and fueling vessels. The mooring area would be approximately 5 to 6 kilometers (3 to 4 miles) north of the RTS harbor (see figure 2.3.1-11). The SBX would enter the lagoon either through Gea Pass on the west side of the atoll or at Mellu Pass on the north side. Both passes offer sufficient depth to accommodate the vessel. Mellu Pass, however, offers a much greater width for maneuverability. If entering at Mellu Pass (the preferred entry point), harbor officials at RTS have identified a likely transportation route to the mooring location called the Kwaj-Roi Highway. There are some obstacles (coralheads, shipwrecks), though, where avoidance would require navigation around and coordination with harbor officials. Personnel would be ferried to the SBX each day either by watercraft or helicopter.

Existing warehouse and administrative space at RTS is available to support SBX operations.



Source: Camber Corporation, 2002 (modified); Woods, 2002.

**EXPLANATION**

-  Pacific Ocean
-  Land
-  Airfield
-  Roads
-  Buildings

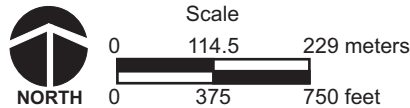

**Candidate  
Ground-Based  
Midcourse Defense  
Locations**

Meck Island, RTS

**Figure 2.3.1-10**

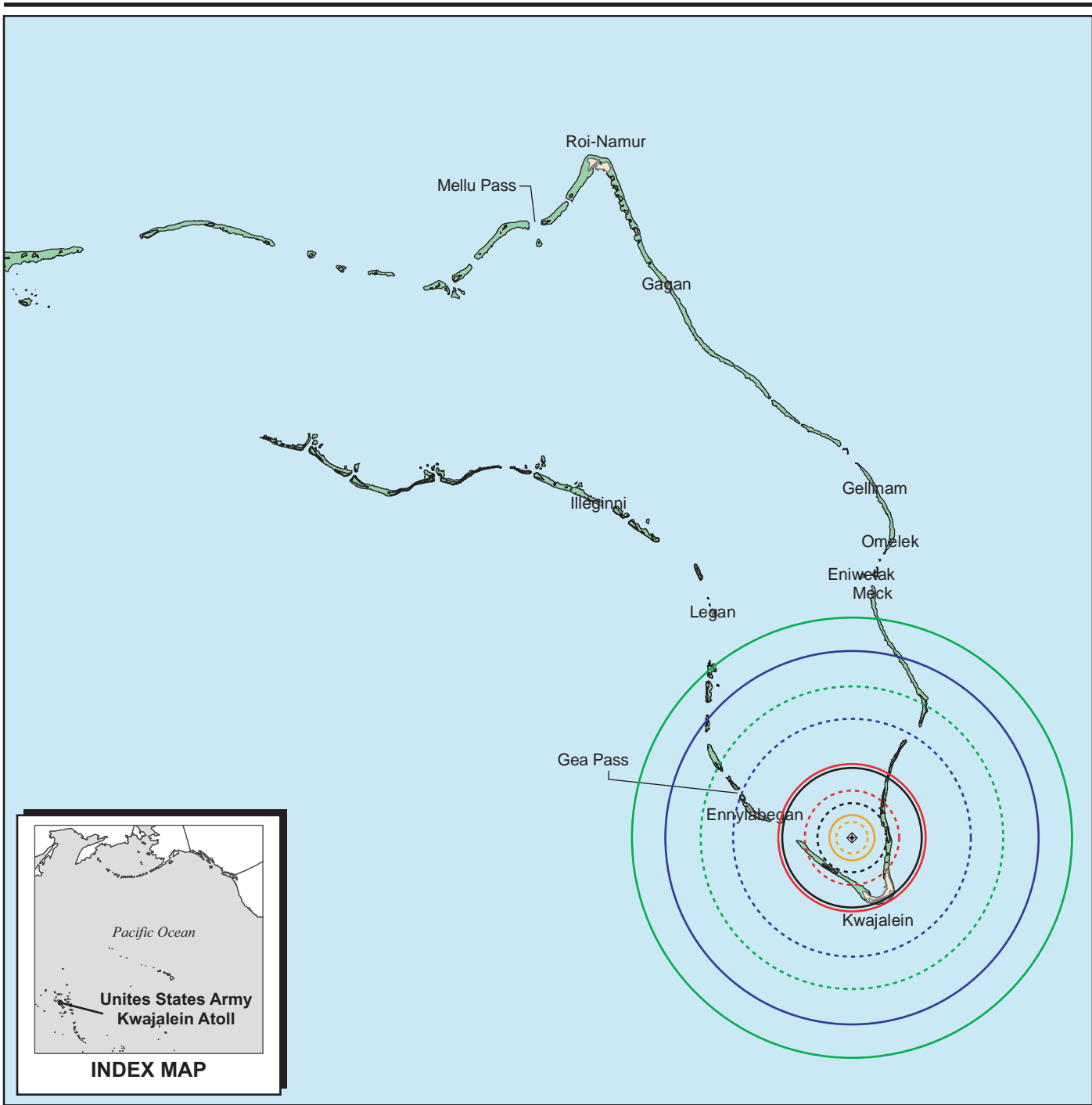

**EXPLANATION**

- Land
- Coral
- SBX Mooring Site

**Potential Interference Distances**

- 22.4 km Full Commercial COMM
  - 19 km Full Aircraft - Main Beam
  - 15.4 km 65% Commercial COMM
  - 12.1 km 65% Aircraft - Main Beam
  - 7.5 km Full (Air) - EEDs Presence/Shipping
  - 7.1 km Full Military COMM
  - 4.8 km 65% (Air) - EEDs Presence/Shipping
  - 3.5 km 65% Military COMM
  - 2.3 km Full (Ground) - EEDs Handling
  - 1.6 km 65% (Ground) - EEDs Handling
- Note: - Full = Fully Populated SBX Radar  
 - 65% = 65% Populated SBX Radar

**Reagan Test Site  
 Potential SBX Mooring  
 Area**

United States Army  
 Kwajalein Atoll

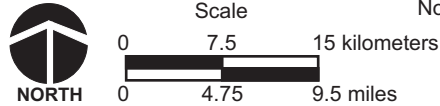

**Figure 2.3.1-11**

### 2.3.1.3.1 Existing Dual Ground-Based Interceptor Launch Capability

Single and dual launches of GBIs would occur from existing silos Com 1 and Com 2 on Meck. The existing GBI Missile Assembly Building, missile storage, maintenance and storage, and launch control facilities would also be utilized (table 2.3.1-4 and figure 2.3.1-10).

**Table 2.3.1-4: Existing Facilities Proposed for Ground-Based Midcourse Defense at Meck Island, Ronald Reagan Ballistic Missile Defense Test Site**

Facility	Quantity	Characteristics
Launch Control Center—no modifications	1	Existing Launch Control Center
Missile Assembly Building—no modifications	1	Currently used for GBI missile assembly
Missile Storage Facility—no modifications	1	Currently used for GBI missile storage
Maintenance and Storage Facility—no modifications	1	Currently used for GBI
Payload Launch Vehicle GBI Silo—modification to launch target missiles	1	Interior of the silo would be modified to accommodate a Minuteman target missile
GBI Launch Silos Com 1 and Com 2—no modifications	1	Recently constructed silos
Target Launch Pad—New construction	1	Previously disturbed area to have reinforced concrete and target launch stool installed on existing launch hill
Construction Laydown Area—no modifications	1	Previously disturbed area for construction equipment

### Target Missile Launch

Dual launches of target missiles would occur from a modified Payload Launch Vehicle GBI silo and a new launch pad, both on Meck. Existing GBI missile launch support facilities identified above would be utilized to support target missile launches.

### Existing Instrumentation

Existing sensors and other instrumentation that would be used at RTS include range radars, the GBR-P prototype XBR, and telemetry instrumentation as described in section 2.1.5.1.3. The GBR-P would be upgraded through the addition of radar elements to the existing radar face and software upgrades.

### 2.3.1.4 Pacific Missile Range Facility

Under Alternative 1, the capability exists at PMRF to support the following activities:

- Launch of a single strategic target for intercepts from either RTS or KLC
- Use of existing range instrumentation to monitor target launch and intercept debris
- TPS-X radar on the Main Base or Makaha Ridge

#### 2.3.1.4.1 Existing Single Target Launch

Up to four Strategic Target System missiles per year may currently be launched from the Kauai Test Facility (KTF) at PMRF. No new missile launch azimuths would be required for the Proposed Action. The current missile trajectories are toward the USAKA/RTS BOA and toward the BOA off the northwest coast of North America. The USAKA/RTS trajectory has been successfully used four times in the last 10 years. Northern trajectories would be implemented using current launch azimuths. Once over open ocean, the missile would then execute a turning maneuver (or series of turns) to bring it onto the desired flight trajectory. As such, the Proposed Action would not require new launch azimuths or the establishment of new special use airspace zones. Facilities required to support a target launch are listed in table 2.3.1-5.

**Table 2.3.1-5: Existing Facilities Proposed for Ground-Based Midcourse Defense at Pacific Missile Range Facility**

Facility	Quantity	Characteristics
Launch Control Center—no modifications	1	Kauai Test Facility
Missile Assembly Building—no modifications	1	Kauai Test Facility
Missile Storage Facility—no modifications	1	Kauai Test Facility
Maintenance and Storage Facility—no modifications	1	Kauai Test Facility
Target Launch Pad—no modifications	1	Strategic Target System Launch Pad
TPS-X—open area, no modifications	1	Alternate site for THAAD radar, existing pad at Makaha Ridge
Construction Laydown Area—no modifications	1	Previously disturbed area for construction equipment

#### 2.3.1.4.2 Existing Instrumentation

Existing sensors and other instrumentation that would be used at PMRF are described in section 2.1.5.

#### 2.3.1.4.3 TPS-X Radar

As described in section 2.1.5, the TPS-X radar is a transportable wide band, X-band, single faced, phased array radar system of modular design. There are two alternative sites at PMRF for the TPS-X as shown on figure 2.3.1-12. The main base TPS-X site is also an alternative site for the THAAD Radar. At Makaha Ridge, the TPS-X would be set up on an existing disturbed area. The TPS-X site would require 0.3 hectare (0.8 acre). The Prime Power Unit is a 1.5-MW generator that provides power to the radar during testing. Operation of the Prime Power Unit would require refueling operations. The fuel tank would be filled from a fuel truck, as necessary. Impermeable ground covering material and spill containment berms would be placed for containment of fuel during fueling operations. Spill control procedures would be established in cooperation with PMRF, and spill control kits would be present at the site in the unlikely event of a fuel leak or spill.

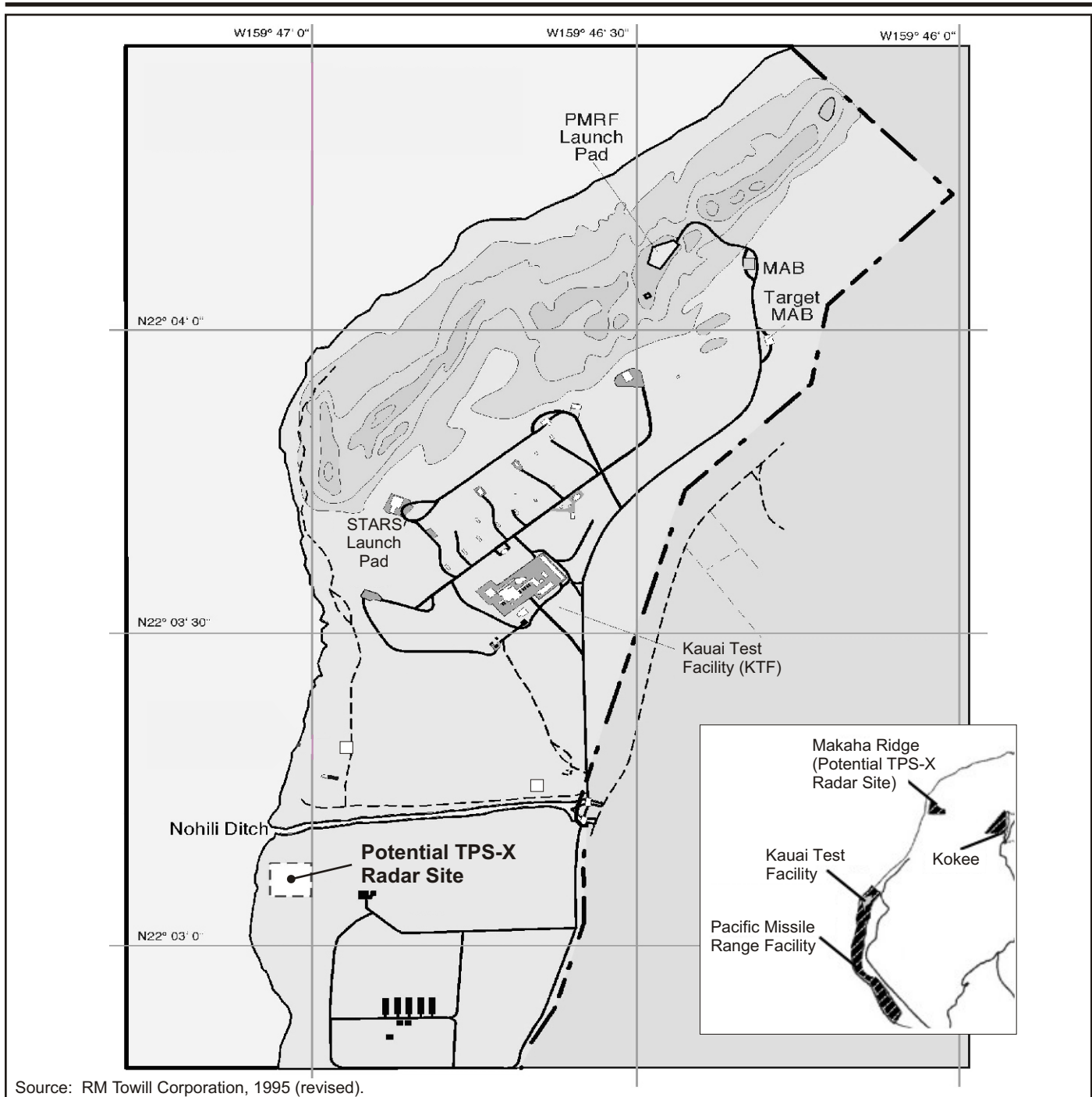

**EXPLANATION**

- PMRF = Pacific Missile Range Facility
- MAB = Missile Assembly Building
- STARS = Strategic Target System
- PMRF Installation Boundary

**Potential TPS-X Radar Sites**

Pacific Missile Range Facility  
Kauai, Hawaii

**Figure 2.3.1-12**



06-096-03 TPS-X PMRF

GMD ETR Final EIS

The Cooling Equipment Unit is a closed system, and no emissions of the ethylene glycol solution are planned. However, because of the remote potential for leaks or spills during system hookup, or the possibility of ruptured hoses or accidental disconnection, impermeable ground cover would be in place as was described for the Prime Power Unit.

EMR hazard exclusion areas would be established around the TPS-X radar antenna as shown on figure 2.3.1-8.

### 2.3.1.5 Vandenberg Air Force Base

Under Alternative 1 Vandenberg AFB would continue to be a launch site for GMD target missiles. The following activities would continue at Vandenberg AFB:

- Launch of single or dual target missiles
- Use of extensive range instrumentation
- Use of TPS-X radar

Vandenberg AFB functions as the test area for space and missile operations, and includes a network of tracking and data-gathering facilities (supplemented by instrumentation on aircraft) throughout California, Hawaii, and the central Pacific. Vandenberg AFB includes a large area of operation and the capabilities to perform a wide range of missile testing. Existing facilities that would be used at Vandenberg AFB are listed in table 2.3.1-6.

**Table 2.3.1-6: Alternative 1 Existing Facilities Proposed for Ground-Based Midcourse Defense at Vandenberg Air Force Base, California**

Facility	Quantity	Characteristics
Launch Control Center—possible minor modifications	1-2	Building 1974
Missile Assembly Building—possible minor modifications	1	Building 6816
Missile Storage Facility—possible minor modifications	1	Existing Bunker
Maintenance and Storage Facility—possible minor modifications	1	Building 6816
Target Launch Silos—possible minor modifications	2	Launch Facility- (LF-) 6 and LF-3
TPS-X Radar—Transportable Unit	1	Located at Area 460 Site

Note: If LF-3 is used to support an initial defensive operations capability, then an additional silo would need to be identified to support a dual target launch. At such time as dual launch requirements are defined, additional environmental planning would be carried out as required.

#### 2.3.1.5.1 Target Launch

Target missiles are currently launched from Launch Facility (LF) -6 and LF-3 in support of the GMD program (see section 2.3.2.1.2). Building 6816 would continue to be used for missile assembly and maintenance and storage. A dual launch capability would require minor interior modifications to some existing facilities.

### **2.3.1.6 Pearl Harbor, Hawaii**

Pearl Harbor is a potential PSB location for the SBX. Pier Victor 3, located on the southeast tip of Pearl City Peninsula, has been identified by the U.S. Navy as the most likely area to support potential SBX activities. The pier is 135 meters (442 feet) long. It is currently supplied with potable water. Prior to November 2002, two types of jet fuel (which could be converted to supply marine diesel oil) were supplied to the pier. Additional work would be required to reestablish fuel service. Power lines run near the pier, allowing for relatively easy modifications to provide the platform with power. Structural augmentation would likely be required to support mooring and material handling operations. The pier is relatively secluded, and it would provide limited access and good security. New warehouses and administrative facilities in the same fenced compound as Pier Victor 3 could be constructed for SBX use. An alternative would be to lease existing administrative/warehouse facilities at an off-base location. If the SBX were to use Pearl Harbor as a PSB, the current plan would be to moor the SBX off of Barbers Point as shown in figure 2.3.1-13. A resupply ship would service the SBX, and personnel would be ferried to the SBX each day either by watercraft or helicopter. If an alternate mooring location is identified for Pearl Harbor, additional environmental planning would be performed.

### **2.3.1.7 Naval Base Ventura County Port Hueneme (California)**

NBVC Port Hueneme is a potential PSB location for the SBX. It is located 97 kilometers (60 miles) northwest of Los Angeles and 80 kilometers (50 miles) south of Santa Barbara. The base itself covers more than 647 hectares (1,600 acres). Warehouse and administrative space is available for lease. An alternative would be to lease existing admin/warehouse facilities at an off-base location. The actual port is neither wide enough nor deep enough to allow the SBX to have pier-side operations. However, San Nicolas Island, located approximately 97 kilometers (60 miles) offshore (figure 2.3.1-14), provides an excellent mooring location. Situated within the Navy's 93,240-square-kilometer (36,000-square-mile) sea test range, San Nicolas Island would also provide a large area of controlled air and sea space for SBX operations while in port. Mooring would probably be on the leeward side of the island, which is on the south/southeast side. Water depths there allow for mooring approximately 800 meters (2,625 feet) offshore. There is a fuel mooring site and undersea pipeline at San Nicolas Island that could support refueling operations. Naval Air Warfare Center, Weapons Division (NAWCWD) controls all air and sea area within the sea range as well as RF management. Both flights and commercial shipping either into or out of Los Angeles pass north or south of the sea test range unless permission is granted by NBVC officials. Flights out of Los Angeles pass either north or south of the sea test range.

San Nicolas Island has a 3,048-meter (10,000-foot) runway and its own power plant. San Nicolas Island is also fully integrated via fiber optics with NBVC Port Hueneme. Construction of a new pier on the island will be completed within 18 months. This pier would not support SBX pier-side operations, but would support ship-to-shore supply operations. Radar emitting at the mooring site is not anticipated to present any conflicts with current operations. Emission fans would be required to work around personnel and contractors living and working on the island, and the sensitive wildlife species found there.





Source: State of Hawaii GIS Data Clearing House, 2002 (modified).

**EXPLANATION**

- Land
- SBX Mooring Site

**Potential Interference Distances**

- 22.4 km Full Commercial COMM
  - 19 km Full Aircraft - Main Beam
  - 15.4 km 65% Commercial COMM
  - 12.1 km 65% Aircraft - Main Beam
  - 7.5 km Full (Air) - EEDs Presence/Shipping
  - 7.1 km Full Military COMM
  - 4.8 km 65% (Air) - EEDs Presence/Shipping
  - 3.5 km 65% Military COMM
  - 2.3 km Full (Ground) - EEDs Handling
  - 1.6 km 65% (Ground) - EEDs Handling
- Note: - Full = Fully Populated SBX Radar  
 - 65% = 65% Populated SBX Radar

**Pearl Harbor Potential SBX Mooring Area**

Oahu, Hawaii

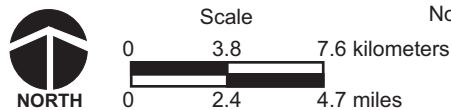

**Figure 2.3.1-13**

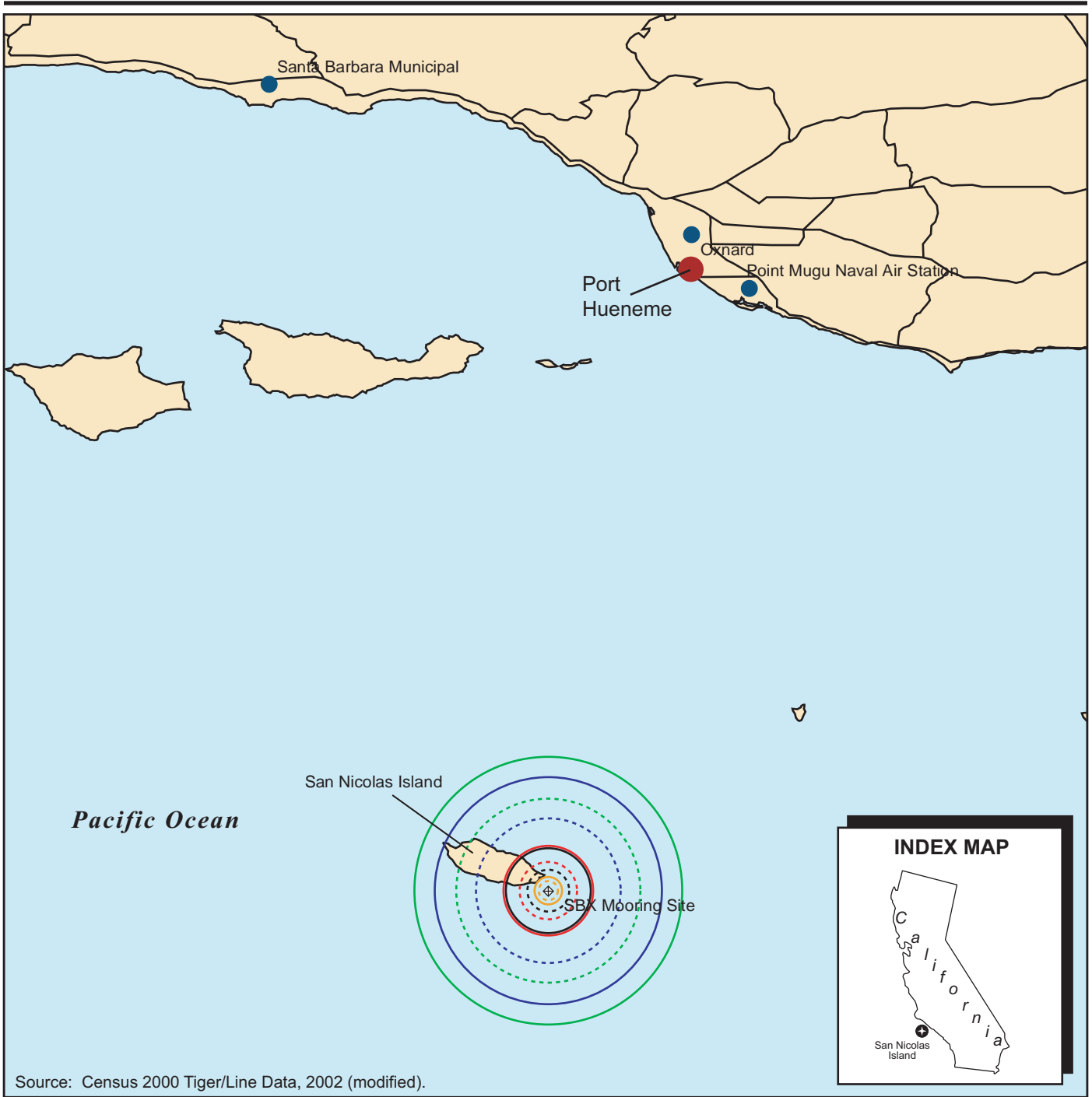

**EXPLANATION**

- Land
- Water
- Major Roads
- Airports
- SBX Mooring Site

**Potential Interference Distances**

- 22.4 km Full Commercial COMM
  - 19 km Full Aircraft - Main Beam
  - 15.4 km 65% Commercial COMM
  - 12.1 km 65% Aircraft - Main Beam
  - 7.5 km Full (Air) - EEDs Presence/Shipping
  - 7.1 km Full Military COMM
  - 4.8 km 65% (Air) - EEDs Presence/Shipping
  - 3.5 km 65% Military COMM
  - 2.3 km Full (Ground) - EEDs Handling
  - 1.6 km 65% (Ground) - EEDs Handling
- Note: - Full = Fully Populated SBX Radar  
 - 65% = 65% Populated SBX Radar

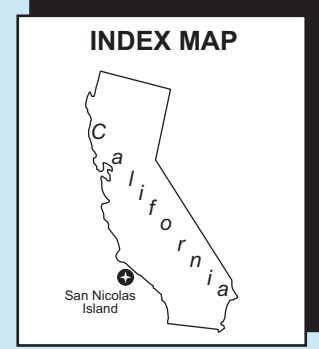
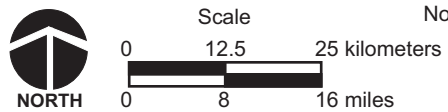

**San Nicolas Island  
 Potential SBX Mooring  
 Area**

Port Hueneme, California

**Figure 2.3.1-14**

### **2.3.1.8 Naval Station Everett (Washington)**

Naval Station Everett is a potential PSB location for the SBX. It is homeport for the Abraham Lincoln Carrier Battle Group, which includes a carrier, three frigates, and three destroyers. The base consists of approximately 47 hectares (116 acres). Currently there is excess warehouse and administrative space available that could be used for the SBX. An alternative would be to lease existing administrative and warehouse facilities at an off-base location. The base has several piers to support the carrier battle group. Pier A has a 16-meter (54-foot) depth, which is used for *USS Abraham Lincoln*. This carrier is out of port approximately 6 months out of the year. The SBX would conduct pier-side operations at either Pier A or the adjacent Pier B. Figure 2.3.1-15 provides a general location of Naval Station Everett and the SBX location. Depths in the harbor would allow the SBX to submerge to operating levels if needed. Naval Station Everett is located relatively close and provides easy access to the Puget Sound main channel.

### **2.3.1.9 Adak, Alaska**

Adak, Alaska, is a potential PSB location for the SBX. Adak is located in the Western Aleutian Islands, approximately 2,092 kilometers (1,300 miles) southwest of Anchorage. A naval base was established on the island when allied forces captured it in 1942. Before its closure in 1996 the population of Adak was about 6,000. The Adak Reuse Corporation is working to develop a community on the island by promoting new business developments. Adak Fisheries Development Council operates a seafood processing and cold storage plant on the island.

Currently, there are approximately 250 personnel on Adak. Former government quarters rented out as individual units serve as lodging accommodations for visitors to Adak. The island also has a hotel, a grocery store, and more than 1,000 housing units each with electric, water, sewer, telephone, and cable television. Dining facilities are limited to two restaurants. Adak has two 2,377-meter (7,800-foot) paved runways with advanced navigation and weather systems as well. There are also the remaining facilities that were established as a part of the naval base, including a port. The Adak port facilities are primarily used by research ships, station work vessels, cruise ships, factory trawlers, and fishing boats. The Port of Adak maintains three cargo and petroleum piers. Docks have approximately 9 meters (30 feet) of draft at mean low tide. The proposed mooring location for the SBX would be in Finger Bay, a relatively deep and protected fjord located south of the main port. Figure 2.3.1-16 provides a general location of Port Adak and the potential mooring location at Finger Bay.

### **2.3.1.10 Valdez, Alaska**

The Port of Valdez is a potential PSB location for the SBX. It is located at the upper end of a 19-kilometer (12-mile) inlet in the Northeast part of Prince William Sound. Valdez is accessible by road, sea, and air, primarily through the Richardson Highway, the Port of Valdez, and the Valdez Airport, respectively. Valdez maintains a year-round population of approximately 4,500 residents, with another 800 to 1,000 seasonal residents.



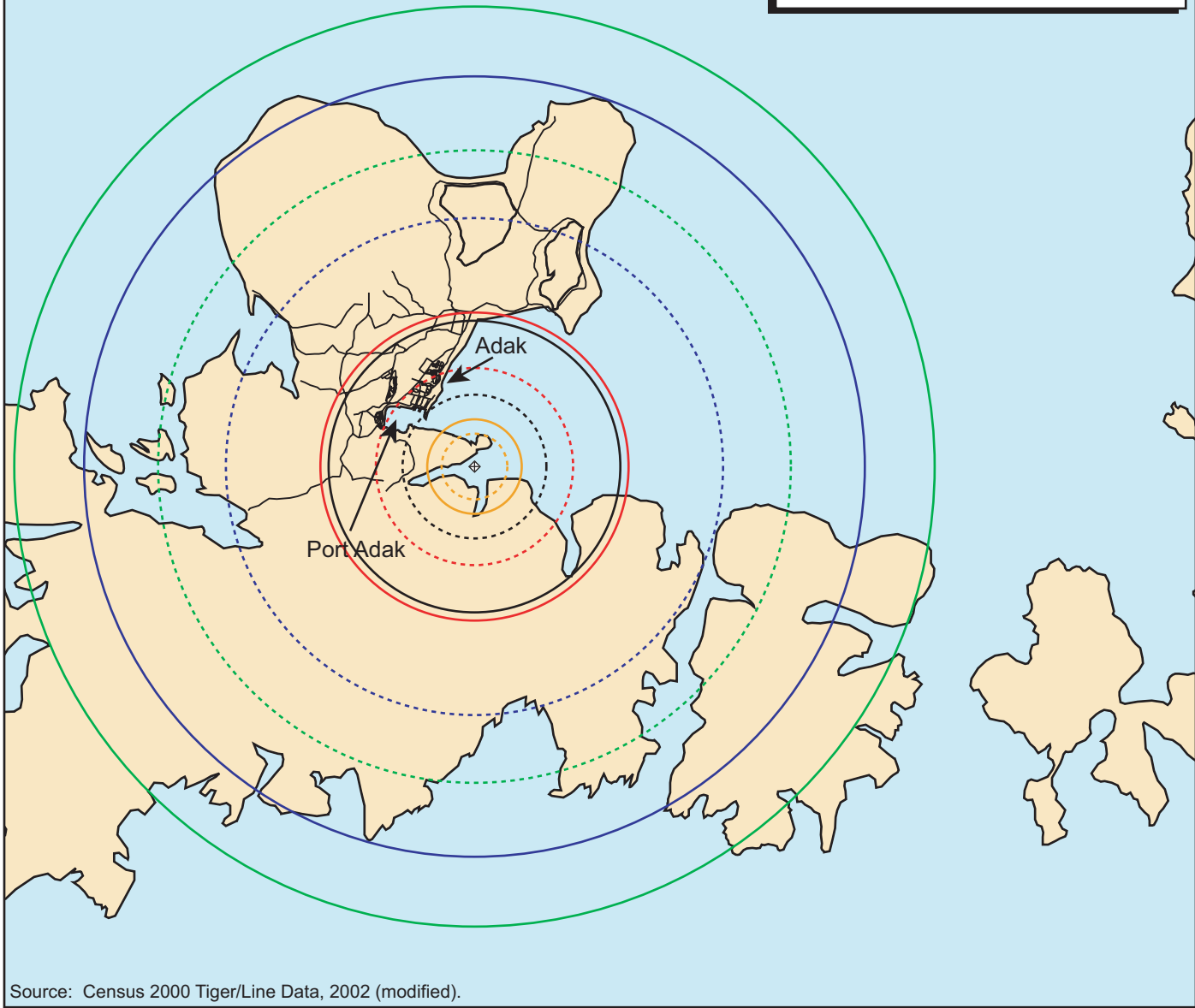
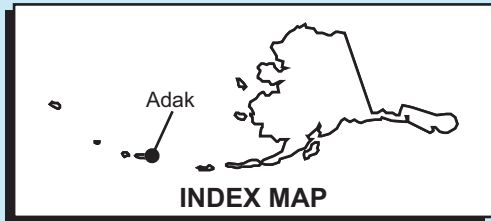

The Port of Valdez is also the terminus of the 1,287-kilometer (800-mile) long Trans-Alaska oil pipeline. Supertankers regularly navigate the Port of Valdez to transport more than 1.5 million barrels per day. The port serves other industries such as commercial fishing, seafood processing plants, and tourist traffic including several cruise ships per year.





Source: Census 2000 Tiger/Line Data, 2002 (modified).

**EXPLANATION**

-  Land
-  Water
-  Roads
-  Potential SBX Mooring Site

**Potential Interference Distances**

-  22.4 km Full Commercial COMM
-  19 km Full Aircraft - Main Beam
-  15.4 km 65% Commercial COMM
-  12.1 km 65% Aircraft - Main Beam
-  7.5 km Full (Air) - EEDs Presence/Shipping
-  7.1 km Full Military COMM
-  4.8 km 65% (Air) - EEDs Presence/Shipping
-  3.5 km 65% Military COMM
-  2.3 km Full (Ground) - EEDs Handling
-  1.6 km 65% (Ground) - EEDs Handling

Note: - Full = Fully Populated SBX Radar  
 - 65% = 65% Populated SBX Radar

**Port Adak Potential SBX Mooring Area**

Adak, Alaska

**Figure 2.3.1-16**

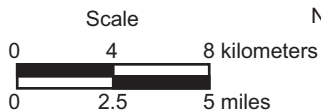

The City Dock would not accommodate the SBX and currently cannot accommodate cruise ships. The City of Valdez is working to upgrade the City Dock to accommodate cruise ships. The North Pacific Fuel Dock, next to the City Dock, is deep enough to accommodate the SBX at high tide. Pier-side operations could be carried out for the SBX at the Container Dock where depths exceed 15.2 meters (50 feet). Valdez does not maintain the pier capacity to commit Container Dock pier-space year round for the SBX, which would yield to cruise ships during the tourist season of May through September. However, there are mooring locations near the container dock and across the Port of Valdez near the Alaska Pipeline terminus. Figure 2.3.1-17 shows a general location of the Port of Valdez.

The Container Dock has approximately 8.5 hectares (21 acres) of staging area. This area is one potential location for constructing warehouse and administration space. The “Old Town” area of Valdez, destroyed in the 1964 earthquake, is another possible location for constructing warehouse and administration space.

#### **2.3.1.11 Mobile Telemetry and C-Band Radar**

As described in section 2.1.5.3, Mobile Telemetry Systems and mobile C-band radar would be required to support the flight testing as a part of the proposed GMD action. Target telemetry requirements include an up-range, mid-range, and down-range telemetry system to support launches. A relatively level area or improved road would be required to site the systems. Intended operations would be to pull the telemetry and radar equipment into a prepared area and utilize a commercial power drop. Generators would provide a backup source of power. Uninterrupted Power Supplies are contained in each unit as an emergency backup if power is lost during a test flight.

#### **2.3.1.12 AN/SPY-1 Radar**

See section 2.1.5.2.2 for a description of the AN/SPY-1 radar system. The Aegis ship would be positioned at various locations in the Pacific to provide missile tracking support during a GMD test.

#### **2.3.1.13 Sea Launch Target**

See section 2.1.2.2 for a description of the Sea Launch Target. The MLP would be positioned at various locations in the Pacific to provide target missiles during a GMD test.

#### **2.3.1.14 Air Launch Target**

See section 2.1.2.2 for a description of the Air Launch Target. The Air Launch Target plane would be positioned at various locations in the Pacific to provide target missiles during a GMD test.

#### **2.3.1.15 Cobra Judy**

See section 2.1.5.2.2 for a description of the Cobra Judy system. The Cobra Judy ship would be positioned at various locations in the Pacific to provide missile tracking support during a GMD test.

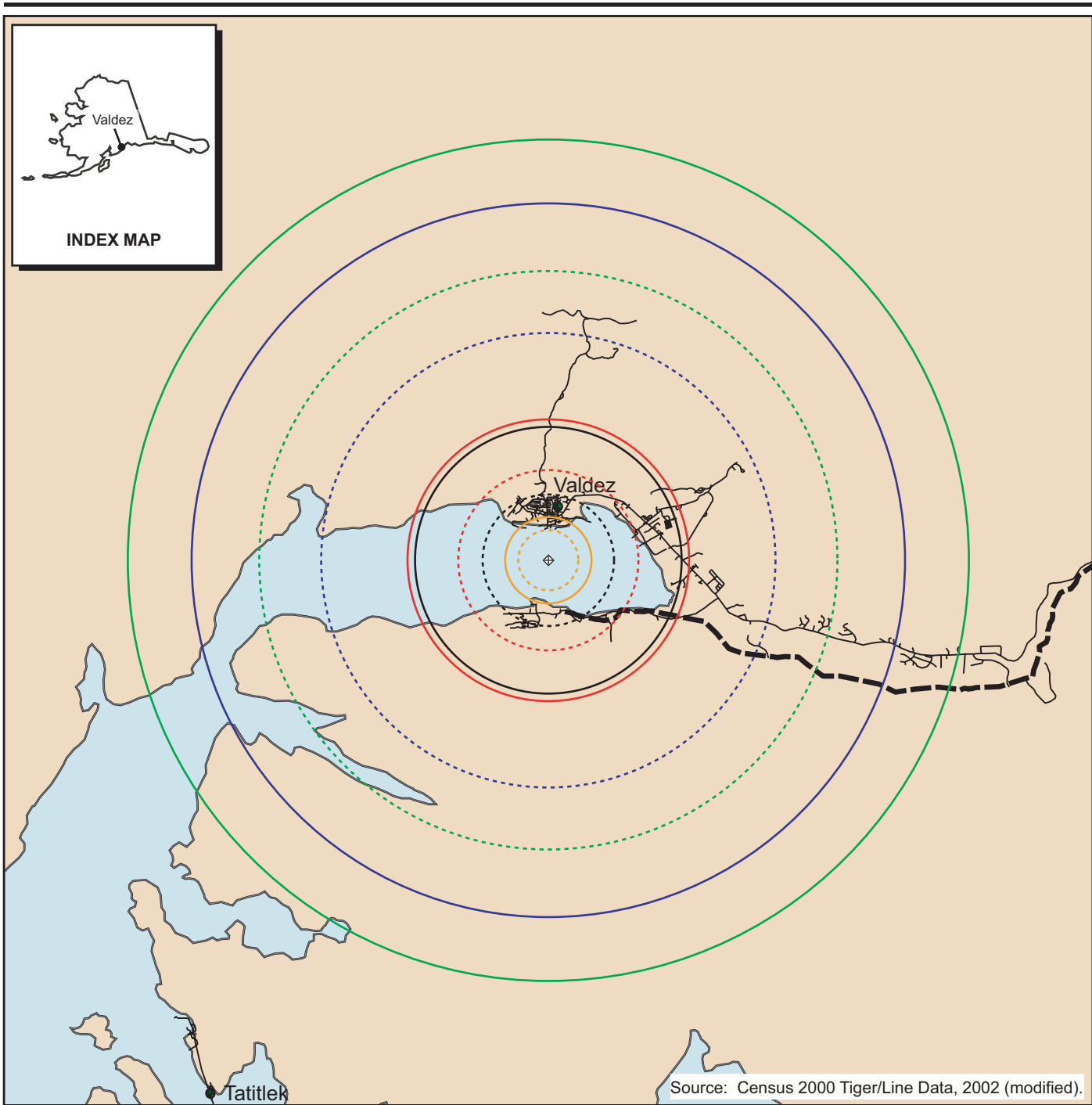

**EXPLANATION**

- Land
- Water
- Roads
- Potential SBX Mooring Site
- Trans-Alaska Pipeline

**Potential Interference Distances**

- 22.4 km Full Commercial COMM
  - 19 km Full Aircraft - Main Beam
  - 15.4 km 65% Commercial COMM
  - 12.1 km 65% Aircraft - Main Beam
  - 7.5 km Full (Air) - EEDs Presence/Shipping
  - 7.1 km Full Military COMM
  - 4.8 km 65% (Air) - EEDs Presence/Shipping
  - 3.5 km 65% Military COMM
  - 2.3 km Full (Ground) - EEDs Handling
  - 1.6 km 65% (Ground) - EEDs Handling
- Note: - Full = Fully Populated SBX Radar  
 - 65% = 65% Populated SBX Radar

**Port of Valdez  
 Potential SBX Mooring  
 Area**

Valdez, Alaska

**Figure 2.3.1-17**

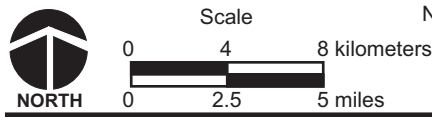

### **2.3.1.16 Components of the Validation of Operational Concept That Would Also Support GMD ETR Testing**

As discussed in section 1.5, the operationally realistic testing of the GMD element directed by MDA is part of the BMDS Test Bed and consists of ground testing to validate the GMD operational concept, and robust flight testing to validate the GMD components. The GMD ETR has several activities and facilities in common with the Validation of Operational Concept testing, including:

- Cobra Dane Radar at Eareckson Air Station, Alaska
- Early Warning Radar at Beale AFB, California
- GFC Nodes at Peterson AFB, Colorado; Schriever AFB, Colorado; Cheyenne Mountain Complex, Colorado; Beale AFB, California; Eareckson Air Station, Alaska; Fort Greely, Alaska; and Boeing facilities in California and Alabama

### **2.3.2 ALTERNATIVE 2**

Alternative 2 would be similar to Alternative 1 with the exception that GBI launches would be from Vandenberg AFB and RTS instead of KLC and RTS. The GBI launch would require construction of an IDT and modifications of existing support facilities at Vandenberg AFB. The existing TPS-X radar at Vandenberg AFB would be utilized. The other components described in Alternative 1 would remain the same.

#### **2.3.2.1 Vandenberg Air Force Base**

Under Alternative 2, Vandenberg AFB would continue to be a launch site for GMD target missiles and would support single and dual GBI launches. The following activities would occur at Vandenberg AFB:

- Single and dual launch of target missiles
- Single and dual launch of GBI missiles
- Construction and operation of a fixed or relocatable IDT
- Use of the existing TPS-X radar
- Use of existing range instrumentation

##### **2.3.2.1.1 Target Launch**

The facilities required to support target missile launches are described in section 2.3.1.5.

##### **2.3.2.1.2 Ground-Based Interceptor Launch**

The following facilities located on Vandenberg AFB may be required for the GBI tests: two silos (to be chosen among silos LF-2, LF-3, LF-10, LF-21, LF-23, and LF-24); Buildings 975, 976, 1032, 1768, 1777, 1801, 1819, 1871, 1900, 1959, 1970, 1978, 6510, 6819, 7000, and 8500, as shown on figure 2.3.2-1 and listed in table 2.3.2-1. Many of these facilities have been used to support GBI booster verification tests and as such would require only minor interior modifications to support continued GMD testing.



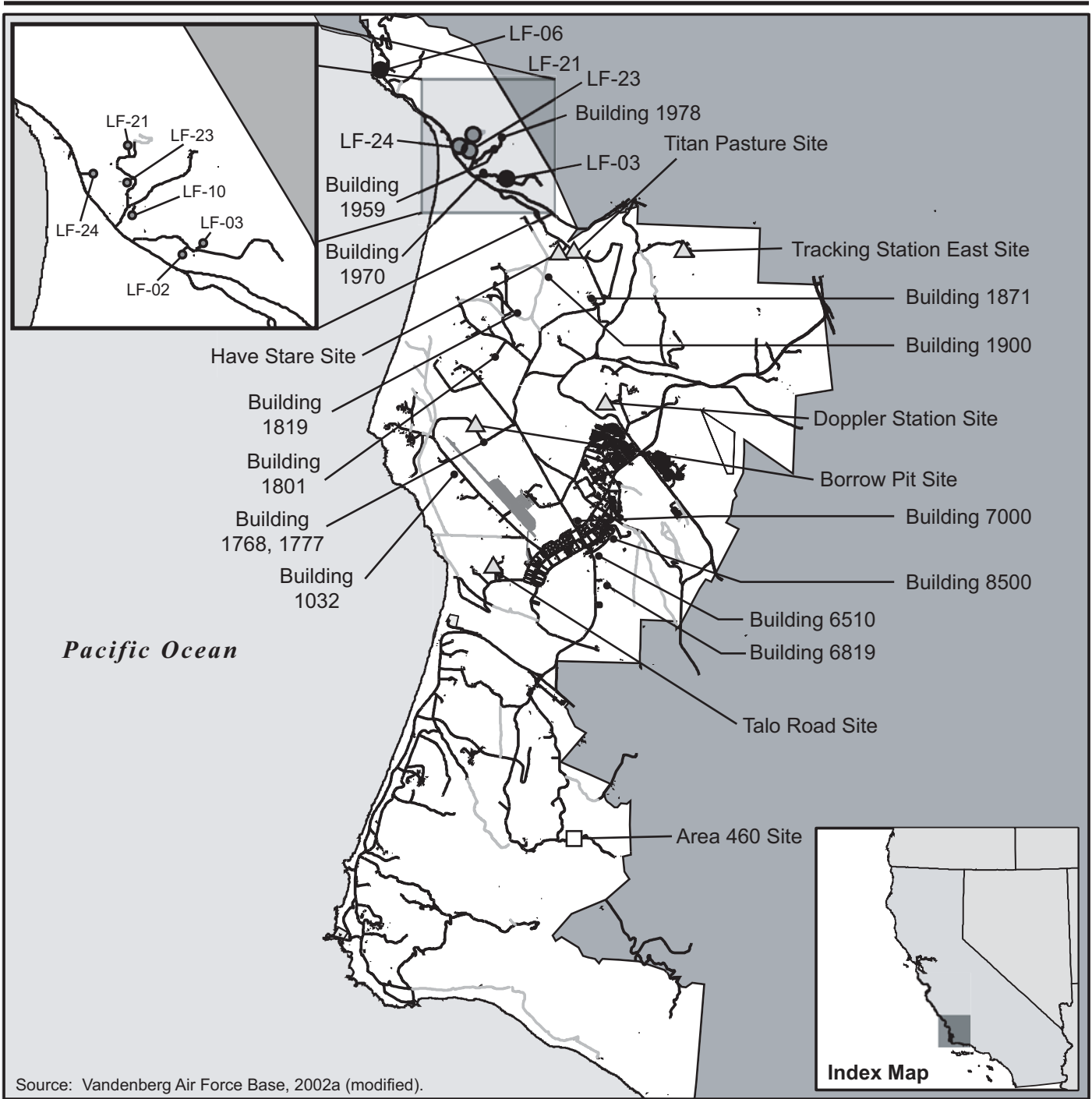

Source: Vandenberg Air Force Base, 2002a (modified).

**EXPLANATION**

- Pacific Ocean
- Vandenberg Air Force Base
- Land
- Target Launch Site
- GBI Launch Site
- IDT Candidate Sites
- Existing TPS-X Radar Site

- LF = Launch Facility
- IDT = In-flight Interceptor Communication System Data Terminal
- GBI = Ground-Based Interceptor
- TPS-X = Transportable System Radar

**Proposed Ground-Based Midcourse Defense Facilities**

Vandenberg Air Force Base, California

**Figure 2.3.2-1**

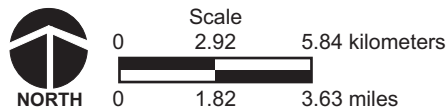

**Table 2.3.2-1: Alternative 2 Existing Facilities Proposed for Ground-Based Midcourse Defense at Vandenberg Air Force Base, California**

Facility	Quantity	Characteristics
Administrative space (office space)	1	Locations within Buildings 1959, 6510, 1801, 1900, and 8500
Launch Control Center—possible modifications	2	Building 1768 and Building 1801
Missile Assembly and GBI Integration and checkout—possible modifications	1	Buildings 1819, 1900, and 1032
Missile Fuel Storage	1	Building 976 (This would be requested as a service)
Oxidizer Storage	1	Building 975 (This would be requested as a service)
Missile Storage Facility—possible minor modifications	1	Building 6819
Maintenance and Storage—possible minor modifications	1	Buildings 1777, 1959, and 1801
Support Equipment Storage	1	Building 1970
Target Launch Silos—possible minor modifications	2	LF-6 and LF-3
GBI Launch Silo alternatives	2	LF-02, LF-03, LF-10, LF-21, LF-23, and LF-24,
Security Response Force Outpost	1	Located in vicinity of Launch Facilities
TPS-X Radar—Transportable Unit	1	Located at Area 460 Site

Note: If LF-03 is used as a GBI silo, then an additional silo would need to be identified to support a dual target launch. At such time as dual launch requirements are defined, additional environmental planning would be carried out as required.

Buildings 1032, 1819, and 1900 may be used for missile assembly and interceptor integration and checkout before launch, and storage of testing and checkout equipment for the GBI missile. They may require facility modifications such as hazardous material detection, alarm, and ventilation to accommodate the EKV processing operations. Building 1900 could be used for missile transporter storage; Buildings 1777, 1801, and 1959 could be used for maintenance and storage. Building 6819 is an existing explosive storage facility that would be used for missile storage. Building 1970 would be used as a storage facility for supporting equipment.

Storage facilities for EKV tanks with small quantities (7.5 liters [2 gallons] or less each) of fuel and oxidizer would be Building 975 for the oxidizer and Building 976 for the fuel.

Buildings 1768 and 1801 could be used as the Launch Control Center for the GBI tests. Modifications inside the buildings would be required.

Buildings 1801, 1900, 1959, 6510, and 8500 would be used for administrative space. Most facilities would require minor modifications. However, Building 1801 would require fairly extensive interior modifications, and the facility has the potential to encounter lead-based paint and asbestos.

LF-21 and LF-23 are currently used for GMD Booster Verification testing. LF-02 is an active silo currently used by the Peacekeeper missile program. LF-03 is an active silo currently used as an MDA target missile silo. LF-10 is an active silo currently used by the Minuteman III missile program. LF-24 is an inactive Minuteman II silo.

Site preparations and modifications were made to LF-21 in order to utilize it for Booster Verification test flights. These modifications were analyzed in the Booster Verification Tests EA (1999). Refurbishments have also been made to LF-23 in order for it to be utilized for GBI launches. These refurbishments were made for the Alternate Boost Vehicle test program and have been previously analyzed under the Alternate Boost Vehicle Verification Tests EA (2002).

Some level of modifications and site preparation could be required at each of the remaining LFs included in the Proposed Action. The proposed launch sites would each include the launch silo, equipment located above ground and within existing below-ground locations, the existing silo access roadways, site utility distribution, and any auxiliary mechanical support equipment. Site preparation could include modifying the existing silo(s) to receive a new prefabricated launch station that would accommodate the installation of the GBI. A "headworks" consisting of a foundation and silo top block would provide an interface for insertion and removal of the GBI. An operational launch silo closure mechanism would be installed at each LF.

All construction staging areas would be located on paved or previously disturbed graded areas. The GMD program would perform sampling and abatement for lead-based paint, asbestos, and polychlorinated biphenyls (PCBs) as required before modification, using Vandenberg AFB-approved procedures. If any of the modifications require the removal of these hazardous wastes, they would be properly disposed of in accordance with work plans developed by GMD personnel and approved by Vandenberg AFB 30<sup>th</sup> Civil Engineering Squadron/Environmental Management Flight (30 CES/CEV).

### **In-Flight Interceptor Communication System Data Terminal**

As described in section 2.1.3, the IDT at Vandenberg AFB could be a fixed land-based unit, a relocatable unit, or a sea-based unit. A fixed IDT would be contained in a building that is approximately 30.7 meters by 11.6 meters (101 feet by 38 feet) and would have a 5.5-meter (18-foot) diameter radome mounted on one end of the building (figure 2.1.3-1). The radome, which covers the antenna, would be inflatable. An external aboveground fuel tank would be located near the building. The mission backup power generator would be located adjacent to the IDT. This generator would be rated at 300 kW and would be housed in a 3.4- by 1.5-meter (11- by 5-foot) wide enclosure. An additional modular facility (or facilities) would be temporarily installed within approximately 30 meters (100 feet) of the IDT. This modular facility would be used to provide spare components and repair parts storage and workspace for technicians. There could be an environmentally protected entrance between the IDT and the modular facility. The modular facility would require communications and utility hookups including local commercial power. Interior water tanks and chemical toilets, inside the modular facility, would be frequently serviced and negate the need for water utility pipes and a septic tank system. The estimated size for these facilities would be approximately 186 to 465 square meters (2,000 to 5,000 square feet). Up to 10 technicians would observe, operate, test, and maintain this facility.

The IDT site would disturb approximately 5.9 hectares (14.6 acres), and include a fenced area of approximately 3.2 hectares (8.0 acres). One IDT site would be selected from the alternative IDT locations shown on figure 2.3.2-1 and listed in table 2.3.2-2. Either a fixed or relocatable IDT could be located at the selected site on Vandenberg AFB. Once the IDT site is selected, the layout would be finalized with installation personnel including 30 CES/CEV. Construction of the IDT would require approximately 35 personnel for a period of 6 months.

**Table 2.3.2-2: Potential Alternative IDT Sites at Vandenberg Air Force Base, California**

Location	Characteristics
HAVE STARE Site	Power and communications on site, existing concrete foundation, existing security fence and light poles
Doppler Station Site	Power and communications on site, existing concrete base
TALO Road Site	Power and communications within approximately 400 meters (1,312 feet) but capacity may be limited; munitions storage and endangered plants nearby
Tracking Station East Site	Power and communications within approximately 120 meters (394 feet), approximately 50 meters (164 feet) of road construction required
Borrow Pit Site	Power and communications within approximately 500 meters (1,640 feet) (along road)
Titan Pasture	Power and communications within 850 meters (2,789 feet) (along road), approximately 50 meters (164 feet) road construction required

The relocatable IDT would essentially be a modular design with a radome similar to the fixed IDT. Operational requirements would be similar to those of the fixed IDT, including a stable foundation, electricity, communications, utilities, security, lighting, and monitoring systems.

Operations and security requirements would be as described in section 2.1.3.

**Communications Cable**

For communication among the components at Vandenberg AFB, the ETR would maximize use of available communications assets, to include cable. If communication cable is not available, new cable would be installed in new conduits, which would be placed in routes designed to avoid environmental impacts and approved by 30 CES/CEV. Trenching for the new communications cable/conduit would have a maximum depth of 0.91 meter (3 feet). Slant/directional drilling is also being proposed as a means of minimizing impacts to the environment if required. Also, the new communications cable/conduit would be buried along existing roads, if possible.

If previously undocumented cultural resource items are discovered during excavation, grading, or other ground-disturbing activities, work would immediately cease. In addition, work would be temporarily suspended within 30 meters (100 feet) of the discovered item until it has been properly evaluated and secured. Any discovery of previously unidentified cultural resources would be reported to the Vandenberg Base Historic Preservation Officer.

Reuse of LF-2, LF-3, or LF-10 would require consultation with the California State Historic Preservation Officer and potential mitigation. Alteration or reuse of any other National Register-eligible Cold War-era facilities would be included in the required consultation.

#### **2.3.2.1.3 Launch Complex Security**

When interceptor testing occurs, it would be on a periodic basis. It is assumed that testing would be on a campaign basis, and the security for these tests would be on a similar basis. It is estimated that the potential security impacts would occur for several weeks for each campaign.

GBI security force personnel would support each campaign. A Security Response Force Outpost would be established in the vicinity of the launch facilities and would be coordinated with Vandenberg security personnel. The installation of additional facility-mounted exterior lighting and chain link security fencing could be required.

Additional physical protection features may be constructed or placed to protect GMD assets. These may include, but are not limited to, fences, security lighting, bollards, tapered concrete barriers or similar devices, ditching and/or earth mounds, patrol roads, and observation tower(s).

Estimates are for several security vehicles to be used. During the operational day, vehicles would be on patrol. At night, additional vehicles would be used as needed. Normal patrols would be confined to existing roads. There would be occasions when these vehicles could be expected to go off-road.

#### **2.3.2.2 Kodiak Launch Complex**

The proposed actions at KLC under Alternative 2 are identical to those described under Alternative 1 for Target missiles. No GBI launches or silo, IDT, or COMSATCOM construction would occur at KLC under Alternative 2. Tables 2.3.2-3 through 2.3.2-5 list existing and proposed facilities for Alternative 2 at KLC.

#### **2.3.2.3 Midway**

The proposed actions at Midway under Alternative 2 are identical to those described under Alternative 1. See section 2.3.1.2 for a description of construction and operations of IDT at Midway. Although Midway was an alternative site in the Draft EIS, MDA has determined that it is no longer a reasonable alternative and will not be a proposed site for ETR activities. The IDT on-board the SBX would perform the function that had been planned for Midway. The discussion of Midway has been retained in the Final EIS, however, in order to preserve the work that has already been performed.

#### **2.3.2.4 Reagan Test Site**

The proposed actions at RTS under Alternative 2 are identical to those described under Alternative 1. See section 2.3.1.3 for a description of dual GBI launches and the SBX PSB at RTS.

### 2.3.2.5 Pacific Missile Range Facility

The proposed actions at PMRF under Alternative 2 are identical to those described under Alternative 1. See section 2.3.1.4 for a description of single target launches and potential operating areas for TPS-X at PMRF.

**Table 2.3.2-3: Alternative 2 Existing Facilities to be Used for Ground-Based Midcourse Defense at Kodiak Launch Complex**

Existing Facility	Quantity	Characteristics
Launch Control Center—minor modifications possible	1	53.3 meters (175 feet) long, 24.4 meters (80 feet) wide, and 12.2 meters (40 feet) high; 100-person occupancy during launches
Payload Processing Facility—potential minor modifications	1	Includes a high bay and a processing bay
Spacecraft Assembly and Transfer Building—no modifications	1	An environmentally conditioned mobile structure used to transfer the launch vehicle stages from the Integration and Processing Facility to Launch Pad 1
Integration and Processing Facility—no major modifications	1	Includes a clean room high bay
Target Launch Pad and Launch Service Structure (LSS)—minor modifications to the LSS	1	Launch Pad 1 consists of the pad and apron, a flame duct, launch equipment vault, and an LSS; the LSS allows for environmental protection and access to the launch vehicle for final assembly and check out in the vertical position.
Planned Maintenance and Storage Facility	1	Planned AADC maintenance and storage facility to be completed in early 2003
COMSATCOM—no modifications	1	Existing satellite communications facility
Hypergolic Fuel Storage Facility—no modifications	1	Storage of liquid fuel
Construction Laydown Areas—no modifications	2	Previously disturbed areas for construction equipment

**Table 2.3.2-4: Alternative 2 Proposed New Facilities for Ground-Based Midcourse Defense at Kodiak Launch Complex**

Proposed Facility	Quantity	Characteristics
Missile Assembly Building	1	Approximately 15 meters (50 feet) wide, 30 meters (100 feet) long, and 18 meters (60 feet) high
Movable Missile Building	1	Approximately 12 meters (40 feet) wide, 21 meters (70 feet) long, and 33.5 meters (110 feet) high, and it would have doors at both ends of the structure
Missile Storage Facility and access road	1	Approximately 30.5 meters (100 feet) wide, by 38.1 meters (125 feet) long, by 5.5 meters (18 feet) high
New Target Launch Pad	1	Approximately 53.3 meters (175 feet) by 53.3 meters (175 feet)
Mancamp	1	Approximately 50 meters (164 feet) wide, 90 meters (295 feet) long, and 10 meters (35 feet) high, with the capacity to house approximately 60 personnel
Addition to existing Narrow Cape Lodge	1	Approximately same size as proposed mancamp

**Table 2.3.2-5: Alternative 2 Potential Ground Disturbance for Ground-Based Midcourse Defense at Kodiak Launch Complex**

<b>Primary Component</b>	<b>Hectares (Acres)</b>	<b>Associated Facilities</b>
Target Associated Construction	10.5 (26.0)	Target access roads, target launch pad, Movable Missile Building, Missile Assembly Building, Motor Storage Building and access road, existing lodge expansion, mancamp
Mobile Telemetry/Mobile C-Band Radar	0.6 (1.4)	Gravel pad

**2.3.2.6 Pearl Harbor, Hawaii**

See section 2.3.1.6 for a description of the SBX PSB at Pearl Harbor, Hawaii.

**2.3.2.7 Naval Base Ventura County Port Hueneme, California**

See section 2.3.1.7 for a description of the SBX PSB at NBVC Port Hueneme, California.

**2.3.2.8 Naval Station Everett, Washington**

See section 2.3.1.8 for a description of the SBX PSB at Naval Station Everett, Washington.

**2.3.2.9 Adak, Alaska**

See section 2.3.1.9 for a description of the SBX PSB at Adak, Alaska.

**2.3.2.10 Valdez, Alaska**

See section 2.3.1.10 for a description of the SBX PSB at Valdez, Alaska.

**2.3.2.11 Mobile Telemetry and C-Band Radar**

See section 2.3.1.11 for a description of mobile telemetry and C-band radar usage to support GMD ETR tests. The mobile telemetry and C-band radar would be positioned at various locations to provide missile tracking support during a GMD test.

**2.3.2.12 AN/SPY-1 Radar**

See section 2.1.5.2.2 for a description of the AN/SPY-1 radar system. The Aegis ship would be positioned at various locations in the Pacific to provide missile tracking support during a GMD test.

**2.3.2.13 Sea Launch Target**

See section 2.1.2.2 for a description of the Sea Launch Target. The MLP would be positioned at various locations in the Pacific to provide target missiles during a GMD test.

#### **2.3.2.14 Air Launch**

See section 2.1.2.2 for a description of the Air Launch Target. The Air Launch Target plane would be positioned at various locations in the Pacific to provide target missiles during a GMD test.

#### **2.3.2.15 Cobra Judy**

See section 2.1.5.2.2 for a description of the Cobra Judy system. The Cobra Judy ship would be positioned at various locations in the Pacific to provide missile tracking support during a GMD test.

#### **2.3.2.16 Components of the Validation of Operational Concept that Would Also Support GMD ETR Testing**

The proposed actions addressed in the Validation of Operational Concept EA under Alternative 2 are identical to those described under Alternative 1. See section 2.3.1.16 for a list of facilities and activities that are a part of ETR flight testing that have been analyzed in the Validation of Operational Concept EA.

### **2.3.3 ALTERNATIVE 3—COMBINATION OF ALTERNATIVES 1 AND 2**

Alternative 3 would include activities proposed for Alternatives 1 and 2. This would include GBI launches from KLC, RTS, and Vandenberg AFB, and construction of the required support facilities for dual launches of GBI and target missiles at each location. At KLC Alternative 3 is the same as Alternative 1.

## **2.4 ALTERNATIVES CONSIDERED BUT NOT CARRIED FORWARD**

As a logical progression leading to the construction of the GMD ETR components, and as an integral part of the NEPA process, a siting study, including the identification of and evaluation of alternative candidate locations, was conducted. Components of the GMD ETR element were evaluated in accordance with the methodology presented in the Ballistic Missile Defense Organization Directive No. 6051, *Comprehensive Siting Analysis Process*. The process consists of several phases: identification of the performance region, Area Narrowing, and Location Evaluation. Exclusionary and evaluative criteria are defined and applied to discriminate among potential candidate locations and sites, and to measure the relative suitability of each to support component operation and sustainment.

The following sections summarize the results of the GMD ETR Siting Study regarding locations that were considered for GMD ETR components but were not carried forward for analysis.

### **2.4.1 GBI LAUNCH LOCATION ALTERNATIVES**

Johnson Atoll, PMRF, and Wake Island were candidate GBI locations that were considered but not carried forward. Johnson Atoll was eliminated because it does not have a functionally similar mission due to the recent transfer of the atoll back to the USFWS. PMRF was not carried forward as a GBI launch location due to its location in line with the other two primary launch locations, Vandenberg AFB and RTS. Due to the flight geometries, a GBI launch site at PMRF would not meet the ETR test objectives. Wake Island was evaluated as a subset of RTS. Due to the proximity of Wake Island and Meck Island in the overall ETR, only one of the sites



could be used. Wake Island was not selected because the facilities at Meck Island are far superior to the facilities at Wake Island.

## **2.4.2 TARGET LAUNCH LOCATION ALTERNATIVES**

Johnson Atoll and Wake Island are the only candidate target locations that were not carried forward. As discussed for the GBI, Johnson was eliminated because it does not have a functionally similar mission due to the recent transfer of the atoll back to the USFWS. Wake Island does not provide additional trajectory options when compared to RTS and lacks the instrumentation available at RTS.

## **2.4.3 IDT LOCATION ALTERNATIVES**

### **2.4.3.1 Remote Land-Based IDT**

The remote IDT Performance Region is located in the middle of the Pacific Ocean. Kure and Midway Atoll (Eastern, Sand, and Spit Islands) were evaluated as candidate locations for the Land-based IDT within the Mid-Pacific performance region. Kure Atoll, Eastern Island, and Spit Island were not carried forward due to insufficient acreage and lack of available infrastructure.

Although Midway was an alternative site in the Draft EIS, MDA has determined that it is no longer a reasonable alternative and will not be a proposed site for ETR activities. The IDT on-board the SBX would perform the function that had been planned for Midway. The discussion of Midway has been retained in the Final EIS, however, in order to preserve the work that has already been performed.

## **2.4.4 SEA-BASED TEST X-BAND RADAR PRIMARY SUPPORT BASE ALTERNATIVES**

The SBX has three candidate performance regions (figure 2.1.4-3). Using the three Performance regions, potential locations for a PSB were identified from one of three geographic areas located within a 2,667-kilometer (1,440-nautical-mile) distance of each performance region. The three areas include southwest Alaska, the U.S. West Coast, and the south/middle Pacific. A minimum of two potential locations in each of the geographic areas were evaluated as PSB Alternatives.

In the southwest Alaska area, Port of Anchorage and Port of Seward did not meet the Mission Compatibility criteria that a PSB location must be capable of supporting storage and transfer of supplies for large-scale commercial shipping activities. The harbor must currently maintain infrastructure to berth and support an offshore supply vessel requiring at least a 24.4-meter (80-foot) pier. Additionally, the location cannot have current or planned activities that would conflict with GMD requirements either at pierside or offshore mooring location.

In the U.S. West Coast area, Naval Magazine Indian Island, Detachment Concord, Naval Submarine Base San Diego, and Naval Weapons Station San Diego, California; and Naval Submarine Base Bangor and Puget Sound Naval Shipyard, Washington, did not meet the Mission Compatibility criteria.

In the south/middle Pacific area, Johnson Atoll, Kaneohe Bay, Hawaii, and Wake Island did not meet the Mission Compatibility criteria. Midway Atoll did not meet the Ownership criteria that the PSB facility shall be located on U.S. DoD land not dedicated toward special-use purposes, or historical sites, etc., or set aside for purposes which are incompatible with the proposed GMD usage.

Based on the application of evaluative criteria, a preliminary rank-order list of 11 sites was developed.

The decision was made to carry forward the top ranked sites, but not more than two sites per area. Sites carried forward in the ETR EIS include:

- Alaska: Port Adak, Alaska and Port of Valdez, Alaska
- U.S. West Coast: Naval Station Everett, Washington and NBVC Port Hueneme, California
- South/Middle Pacific: Naval Station Pearl Harbor, Hawaii and RTS, Kwajalein Atoll

Locations not carried forward for further analysis included Naval Station San Diego and Naval Station North Island, California; Dutch Harbor and U.S. Coast Guard Station Kodiak, Alaska; and Naval Station Bremerton, Washington.

A supplemental SBX siting study is underway to support the initial defensive operations capability mentioned in section 1.2. Because the SBX operations at the PSB in support of initial defensive operations would be identical to those in support of the ETR, the supplemental siting study will start with the six PSB locations identified for the ETR. The application of additional evaluative criteria related to initial defensive operations will be applied to determine the final rank order of the six candidate PSBs. This ranking is likely to be different than the preliminary rank order of the 11 sites.

#### **2.4.5 MOBILE TELEMETRY AND MOBILE C-BAND RADAR LOCATION ALTERNATIVES**

Locations evaluated as potential sites for mobile telemetry and mobile C-band radar but not carried forward for further analysis included Soldotna, Kenai, King Cove, Sand Point, Seldovia, Cold Bay, Dillingham, Sitka, Juneau, and Chignik, Alaska. The lack of sufficient parcel size, supportability, commercial power, and line of sight requirements made these sites unsuitable for the placement of mobile telemetry and mobile C-band radar.